

FLEX DC® 88 RGB is a high performance flexible LED fixture suitable for use in coves, under cabinets, in shelves, in-grade, and virtually anywhere a linear fixture is required.

- FLEX DC® RGB is dimmable via DMX.
- IP68 version is UV resistant

ELECTRICAL

Input Voltage	24VDC
Dimming Options	• DMX
Power Consumption	8.8 Watts per foot
Wire Size	18AWG, 4 wire
Certification	ETL - Conforms to UL Std. 2108; Certified to CSA Std. C22.2 No. 9.0

PHYSICAL

Field Cuttable	Every 1.96"
Operating Temperature	-40° C (-40°F) to +70°C (+158°F)
Environment	IP40 - Dry Location IP68 - Wet Location
Maximum Class 2 Run Length	IP40: 10', IP68: 10'
Dimensions (W x H):	IP40 - 0.63" (15.88mm) x 0.13" (3.18mm) IP68 - 0.69" (17.47mm) x 0.25" (6.35mm) IP68 Endcaps - 0.33" (8.40mm) x 0.77" (30.17mm)

ACCESSORIES

Channels	Optic Arts® Channel (pg. 3-5)
Connectors	LC-ISP-M, LC-ISP-F, LC-O5P-F, LC-O5P-M (pg. 6)
NOTE: IP40 version must be used in conjunction with Optic Arts® "THERMTAPE" and Optic Arts® Channel for proper heat dissipation.	

LUMEN OUTPUT

(All Leds At 100%)	347.61 lm/ft 39.51 lm/watt
<i>*Stated lumen values have a tolerance of +/- 10%.</i>	

PERFORMANCE

Lumen Maintenance	50,000 Hours
Warranty	5 years

PART NUMBER BUILDER

SERIES	+	IP RATING	+	COLOR	+	VOLTAGE	+	WATTAGE	+	CONFIGURATION	+	LENGTH
FLEXDC		40 = IP40 - Dry Location 68 = IP68 - Wet Location		RGB		24 = 24 VDC		88 = 8.8W		FLC1 = FLEX Config 1 FLC2 = FLEX Config 2 FLC3 = FLEX Config 3		XX = Custom Length



DIMENSIONS

Optic Arts® cuts all FLEX DC® and Channel products to length per customer specifications. Each length of FLEX DC® is fitted with a 6' wire lead (custom lengths available upon request) and packaged on a reel in an anti-static bag. Bags are labeled with fixture type, length and location (if applicable). Each piece of channel is labeled with fixture type, length and location (if applicable), and is bundled by fixture type.

- Due to the nature of the FLEX DC® product, specific lengths may not fall exactly on a cutting point. In this case, Optic Arts® will always cut to the smaller dimension unless otherwise specified.
- Unless otherwise specified, channel is cut 15mm longer than FLEX DC®.
- Some on-site assembly required. See installation guides for details.

INDOOR FLEX DC® 88

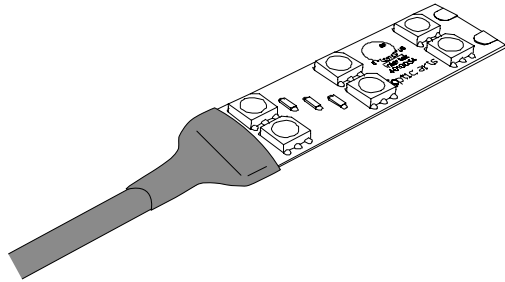
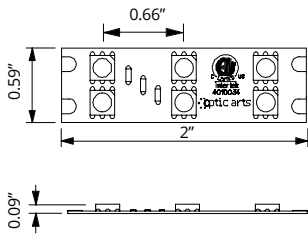

INDOOR DIMENSIONS

Width	0.59" (14.97mm)
Height	0.09" (2.21mm)
Cuttable Segment Length	1.96" (49.75mm)
Pitch Length	0.66" (16.75mm)
Max Run Length	10.00' (3048.00mm)

OUTDOOR FLEX DC® 88

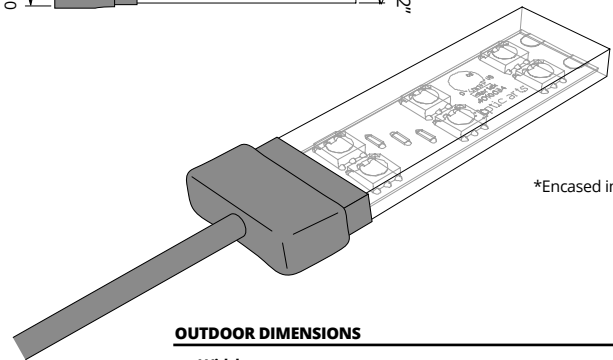
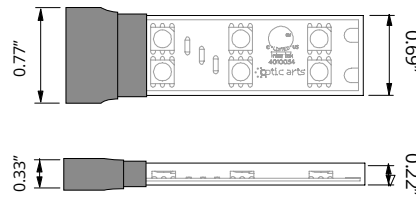

OUTDOOR DIMENSIONS

Width	0.69" (17.61mm)
Height	0.77" (5.59mm)
Width (Endcap)	0.77" (19.54mm)
Height (Endcap)	0.33" (8.40mm)
Max Run Length	10.00' (3048.00mm)

INDOOR FLEX DC® 88

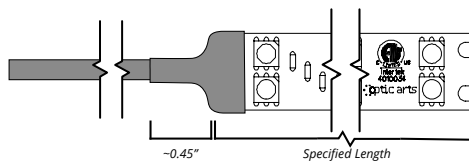

OUTDOOR FLEX DC® 88

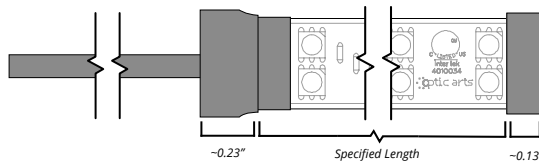

KEY

CHANNEL PART NUMBER BREAKDOWN:

CHS	+	R	+	1208
SERIES		APPLICATION		DIMENSIONS
CHS = Slim Channel CHW = Wide Channel		S = Surface Mount R = Recessed Mount C = Corner Mount H = Hanging Mount		XXXX = W x H (mm)

CHS-R-1208

• Click on channel titles below to access complete channel cut sheets

DIFFUSION LEVEL:

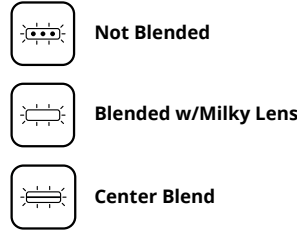

CONFIGURATION:

- 1** Configuration 1
- 1a** Configuration 1 with Auxiliary Housing Accessory
- 2** Configuration 2
- 3** Configuration 3

CORNER CHANNELS

CHW-C-3030

Fits IP40 FLEX DC® Only

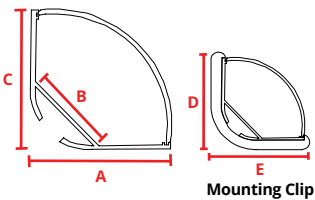

A: 1.18" (30.00mm) **D:** 1.29" (32.77mm)
B: 0.78" (20.20mm) **E:** 1.29" (32.77mm)
C: 1.18" (30.00mm)

	MATERIAL Anodized Aluminum
1	DESCRIPTION 45 degree channel with rounded lens.
2	LENGTH 2 meter
3	LENS TYPES Clear CHW-C-3030-CC Frosted CHW-C-3030-CF Milky CHW-C-3030-CM
ACCESSORIES	
	Endcap CHW-C-3030-EC
	Endcap w/hole CHW-C-3030-ECH
	Mounting Clip CHW-C-3030-MC

CHW-C-3030S

Fits IP40 FLEX DC® Only

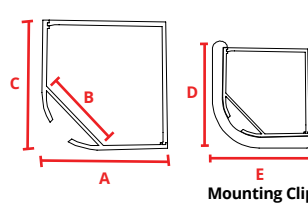

A: 1.18" (30.00mm) **D:** 1.29" (32.77mm)
B: 0.78" (20.20mm) **E:** 1.29" (32.77mm)
C: 1.18" (30.00mm)

	MATERIAL Anodized Aluminum
1	DESCRIPTION 45 degree channel with square lens.
2	LENGTH 2 meter
3	LENS TYPES Clear CHW-C-3030S-CC Frosted CHW-C-3030S-CF Milky CHW-C-3030S-CM
ACCESSORIES	
	Endcap CHW-C-3030S-EC
	Endcap w/hole CHW-C-3030S-ECH
	Mounting Clip CHW-C-3030S-MC

SPECIALTY CHANNELS

CHW-S-3535

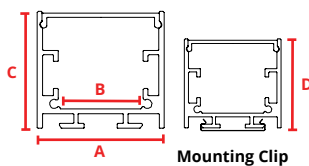

A: 1.39" (35.25mm)
B: 0.96" (24.50mm)
C: 1.39" (35.25mm)
D: 1.54" (39.00mm)

*Must specify for hanging or surface mount application.

	MATERIAL Anodized Aluminum
1	DESCRIPTION Wide and deep surface mounted or hanging channel. Eliminates visible LED nodes for most FLEXDC products when used with a milky lens.
2	LENGTH 2 meter
3	LENS TYPES Frosted CHW-35mm-CF Milky CHW-35mm-CM
ACCESSORIES	
	Endcap CHW-S-3535-EC
	Endcap w/hole CHW-S-3535-ECH
	Mounting Clip CHW-S-3535-MC
	Hanging Hardware CHW-SH-3535-MW
	Bracket Straight CHW-S-XX35-BS
	Bracket 90° Flat CHW-S-XX35-B90F
	Bracket 90° Raised CHW-S-XX35-B90R
	End Cap for FLEX AC CHW-S-3535-ECAC
	Mounting Clip for FLEX AC CHW-S-3535-MCAC
	VHB Tape VHBTAPE.AC

CHW-R-4435

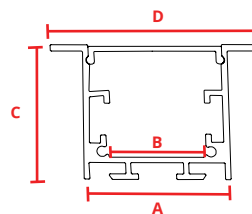

A: 1.39" (35.25mm)
B: 0.96" (24.50mm)
C: 1.39" (35.25mm)
D: 2.00" (51.04mm)

	MATERIAL Anodized Aluminum
1	DESCRIPTION Wide and deep recessed channel. Eliminates visible LED nodes for most FLEXDC products when used with a milky lens. Can be securely and conveniently mounted with CHW-R-4435-SC spring clip.
2	LENGTH 2 meter
	LENS TYPES Frosted CHW-35mm-CF Milky CHW-35mm-CM
ACCESSORIES	
	Endcap CHW-R-4435-EC
	Endcap w/hole CHW-R-4435-ECH
	Mounting Clip CHW-R-4435-SC
	Bracket Straight CHW-S-XX35-BS
	Bracket 90° Flat CHW-S-XX35-B90F
	Bracket 90° Raised CHW-S-XX35-B90R
	End Cap for FLEX AC CHW-R-4435-ECAC
	Mounting Clip for FLEX AC CHW-R-4435-MCAC
	VHB Tape VHBTAPE.AC

MOUNTING OPTIONS - COMPATIBLE CHANNELS

- Not Blended
 Blended w/Milky Lens
 1 Configuration 1
 1a Configuration 1 with Auxiliary Housing Accessory
 2 Configuration 2
 3 Configuration 3

SPECIALTY CHANNELS

CHW-S/H-3561

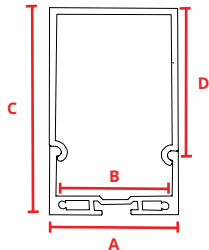

A: 1.38" (35.00mm) **C:** 2.43" (61.70mm)
B: 1.24" (31.40mm) **D:** 1.57" (39.90mm)



MATERIAL
Anodized Aluminum



DESCRIPTION
Large surface mounted or hanging channel with wrap around lens.



LENGTH
2 meter

LENS TYPES
Milky CHW-SH-3561-CM

ACCESSORIES
 Endcap CHW-SH-3561-EC
 End Cap w/hole CHW-SH-3561-ECH
 Hanging Hardware CHW-SH-MW
 Bracket Straight CHW-SH-BS
 Bracket 90° Flat CHW-SH-B90F
 Bracket 90° Raised CHW-SH-B90R

*Must specify for hanging or surface mount application.

CHW-S/H-3030

Fits IP40 FLEX DC® Only

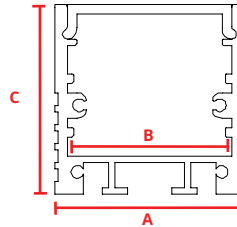

A: 1.18" (30.00mm)
B: 1.01" (25.60mm)
C: 1.18" (30.00mm)



MATERIAL
Anodized Aluminum



DESCRIPTION
Wide and deep surface mounted or hanging channel with flat lens for even blending.



LENGTH
2 meter

LENS TYPES
Milky CHW-SH-3030-CM

ACCESSORIES
 Endcap CHW-SH-3030-EC
 Endcap w/hole CHW-SH-3030-ECH
 Hanging Hardware CHW-SH-MW
 Bracket Straight CHW-SH-BS
 Bracket 90° Flat CHW-SH-B90F
 Bracket 90° Raised CHW-SH-B90R
 End Cap for FLEX AC CHW-SH-3030-ECAC
 Mounting Clip for FLEX AC CHW-SH-3030-MCAC
 VHB Tape VHBTAPE.AC

*Must specify for hanging or surface mount application.

CHW-S/H-7532

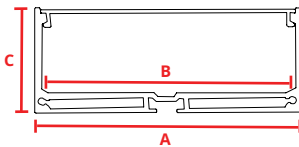

A: 2.95" (75.00mm)
B: 2.52" (64.00mm)
C: 1.26" (32.00mm)



MATERIAL
Anodized Aluminum



DESCRIPTION
Wide surface mounted or hanging channel with flat lens.



LENGTH
2 meter

LENS TYPES
Frosted CHW-SH-7532-CF

ACCESSORIES
 Endcap CHW-SH-7532-EC
 Endcap w/hole CHW-SH-7532-ECH
 Hanging Hardware CHW-SH-MW
 Bracket Straight CHW-SH-BS
 Bracket 90° Flat CHW-SH-B90F
 Bracket 90° Raised CHW-SH-B90R

*Must specify for hanging or surface mount application.

CHW-S-2623

Fits IP40 FLEX DC® Only

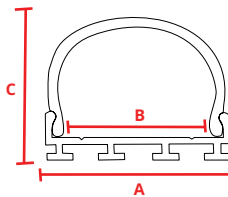

A: 1.03" (26.20mm)
B: 0.80" (20.35mm)
C: 0.89" (22.76mm)



MATERIAL
Anodized Aluminum



DESCRIPTION
Surface mounted channel with wrap around lens.



LENGTH
2 meter

LENS TYPES
Milky CHW-S-2623-CM

ACCESSORIES
 Endcap CHW-S-2623-EC
 Endcap w/hole CHW-S-2623-ECH

ACCESSORIES

LC-I5P-M

Indoor Lead Connector
(Male)

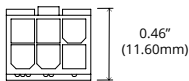
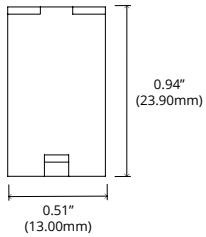
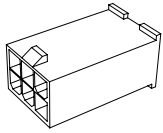

LC-I5P-F

Indoor Lead Connector
(Female)

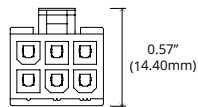
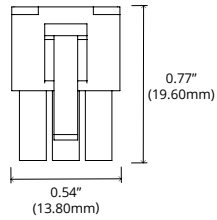
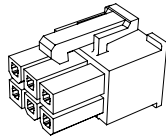

LC-O5P-F

Outdoor Lead Connector
(Female)

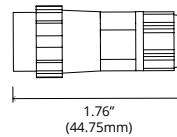
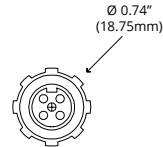
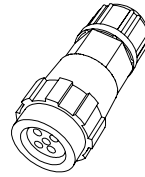

LC-O5P-M

Outdoor Lead Connector
(Male)

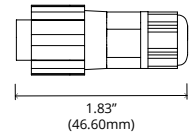
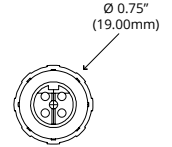
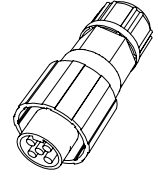

FLEX.ZIP

Strain Relief Clip

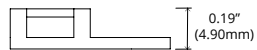
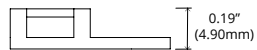
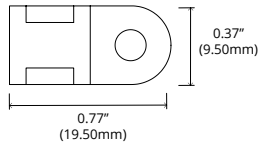
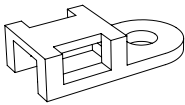

CONFIGURATION TYPES

1 [NOT COMPATIBLE] FLEX cut to length with FLEX Connect® Power Feeds for Field Termination, Channel uncut for field cutting

- Specify **FLEXConfig-1**
- Specify FLEX type and channel type
- FLEX factory cut to length, but not terminated
- One FLEX Connect® power feed connector and 6' lead provided per FLEX run
 - Uncut rolls of lead wire can also be provided (see page 8 for part #)
- Channel shipped uncut for field cutting.
- Specify number of butt splices (not shown - see page 8)
- IP68 not available in **FLEXConfig-1**
- JA8 2016 not available in **FLEXConfig-1**
- FLEXConfig-1** is quick ship if run lengths are provided at time of order. Take offs, if needed, will add lead time.
- The below channels are **NOT** compatible with FLEX Connect®:
 - Slim:**
 - CHS-R-1208
 - CHS-R-1715
 - CHS-C-1616
 - CHC-S-1921
 - Specialty:**
 - CHSP-R-2970
 - CHSP-S-1618
 - CHSP-STEP-8142

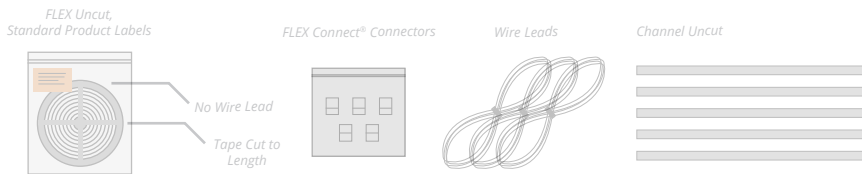

2 Cut To Length With Soldered Leads, Assemble On-Site^{1, 2, 3}

- Specify **FLEXConfig-2**
- Specify FLEX type and channel type
- Specify run lengths
- IP68 only available in **FLEXConfig-2**
- If no config is specified, and run lengths are provided, **FLEXConfig-2** will be used

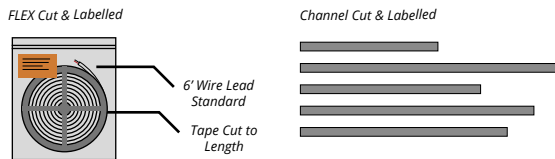

3 Pre-Assembled Factory Finished Fixtures^{1, 2}

- Specify **FLEXConfig-3**
- Fully assembled fixture
- ETL stamped and listed as a fixture
- 6.50' max length
- Standard 6' power lead unless otherwise specified
- The below channels **CANNOT** be factory assembled:
 - Slim:**
 - CHS-R-1208
 - CHS-R-1715
 - Wide:**
 - CHW-R-2010
 - CHW-S-2027
 - CHW-S-7532
 - CHW-S-2623
 - CHW-S-3030
 - CHW-S-3561

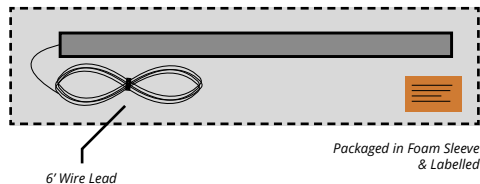

NOTES:

- Due to the nature of the FLEX DC® product, specific lengths may not fall exactly on a cutting point. In this case, Optic Arts® will always cut to the smaller dimension unless otherwise specified.
- Unless otherwise specified, channel is cut 15mm longer than FLEX DC®.
- Some on-site assembly required. See installation guides for details.

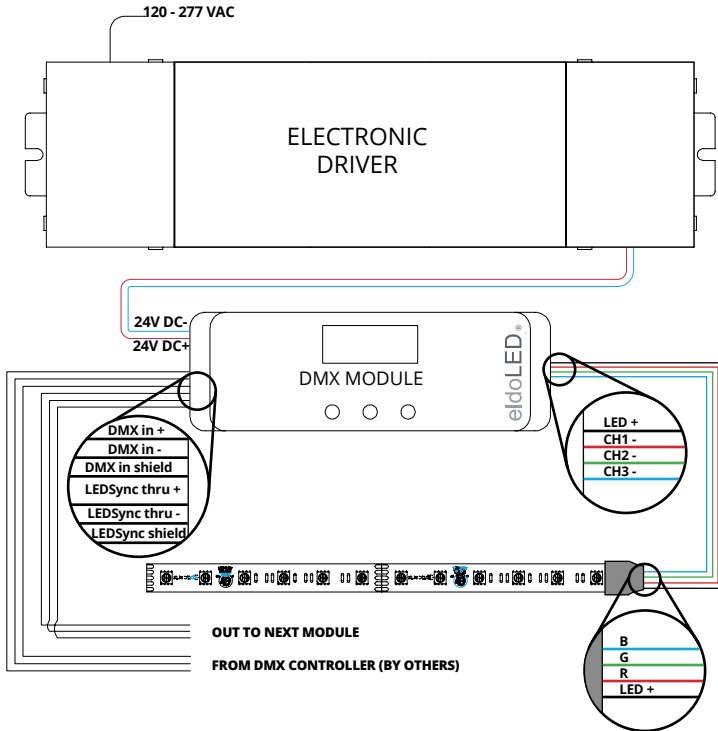

ELECTRONIC DRIVER W/DMX MODULE

PART	DESCRIPTION
GG100E-24-UNV-DMX	96W 120-277VAC ELECTRONIC DRIVER WITH eldoLED DMX DIMMING MODULE
DIMENSIONS	
96W	H 3.00"; W 11.46"; D 1.30"
DMX MODULE	H 1.97"; W 6.02"; D 0.91"

**Must be installed in UL box (by others)*

DIMMING PERFORMANCE

ELECTRONIC DRIVER - DMX MODULE Dims to 0.1% on most DMX systems