

FLEX DC® 22 is a high performance flexible LED fixture suitable for use in coves, under cabinets, in shelves, in-grade, and virtually anywhere a linear fixture is required.

ELECTRICAL

Input Voltage	24VDC
Dimming Options	<ul style="list-style-type: none"> • PURE DC™ • MLV • 0-10V • DMX • Lutron (2-WIRE, 3-WIRE, EcoSystem)
Power Consumption	2.2 Watts per foot
Wire Size	18AWG, 2 wire
Certification	<p>ETL - Conforms to UL Std. 2108; Certified to CSA Std. C22.2 No. 9.0</p> <p>Closet Rated - Suitable for installation in the storage area of a clothes closet when used in Optic Arts® channel.</p> <p>Title 24 - Selected models are JA8 2016 compliant when used with 0-10V, DMX, Lutron A-Series 2-Wire or Lutron Premier dimming. JA8 option must be specified in part number builder below.</p>

PHYSICAL

Field Cuttable	Every 6.55"
Operating Temperature	-40° C (-40°F) to +70°C (+158°F)
Environment	<p>IP40 - Dry Location</p> <p>IP68 - Wet Location</p>
Maximum Run Length	IP40: 43', IP68: 43'
Dimensions (WxH)	<p>IP40 - 0.40" (10.05mm) x 0.10" (2.33mm)</p> <p>IP68 - 0.50" (12.70mm) x 0.20" (5.15mm)</p> <p>IP68 Endcaps - 0.57" (14.48mm) x 0.38" (9.65mm)</p>

ACCESSORIES

Mounting Clips	FLEXMNT.SIL.INT, FLEXMNT.SIL.EXT12 (pg. 8)
Channels	Optic Arts® Channel (pg. 3-7)
Connectors	LC-I2P-M, LC-I2P-F, LC-O2P-F, LC-O2P-M (pg. 8)
FLEXConfig-1 Accessories	<p>FLEXDC.PFC.02.10, FLEXDC.BSC.02.10,</p> <p>LO-18G-2C-W-72, LP-18G-2C-W-72,</p> <p>LO-18G-2C-W-SP, LP-18G-2C-W-SP (pg. 9)</p>

LUMEN OUTPUT

2000K (IP40 only)	183 lm/ft 83.27 lm/Watt
2400K	196 lm/ft 89.10 lm/Watt
2700K	194 lm/ft 88.00 lm/Watt
3000K¹	206 lm/ft 93.70 lm/Watt
3500K¹	222 lm/ft 100.80 lm/Watt
4100K¹	224 lm/ft 101.70 lm/Watt
6000K¹	207 lm/ft 94.10 lm/Watt

Note: Stated lumen values have a tolerance of +/- 10%.

1: Offered in JA8 when used with 0-10V, DMX, Lutron A-Series 2-Wire or Lutron Premier dimming (IP40).

PERFORMANCE

CRI	90+
Lumen Maintenance	50,000 Hours
Binning Tolerance	+/- 100K
Warranty	5 years

PART NUMBER BUILDER

SERIES	+	IP RATING	+	COLOR	+	VOLTAGE	+	WATTAGE	+	CONFIGURATION	+	LENGTH	+	JA8		
FLEXDC		40 = IP40 - Dry Location 68 = IP68 - Wet Location		20 = 2000K (IP40 only) 24 = 2400K 27 = 2700K 30 = 3000K ¹ 35 = 3500K ¹ 41 = 4100K ¹ 60 = 6000K ¹		R = Red G = Green B = Blue A = Amber		24 = 24 VDC		22 = 2.2W		FLC1 = FLEX Config 1 FLC2 = FLEX Config 2 FLC3 = FLEX Config 3		XX = Custom Length		Y = Yes N = No

1: Offered in JA8 when used with 0-10V, DMX, Lutron A-Series 2-Wire or Lutron Premier dimming (IP40).

DIMENSIONS

INDOOR FLEX DC® 22

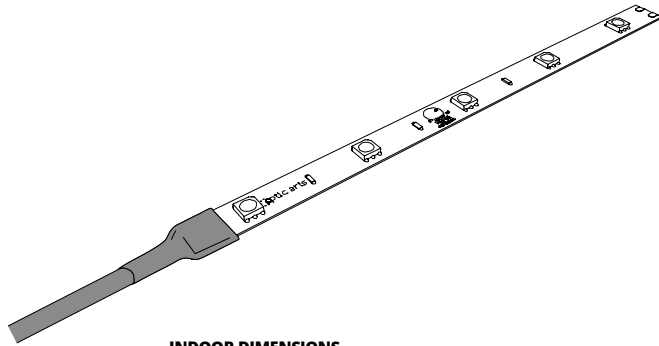
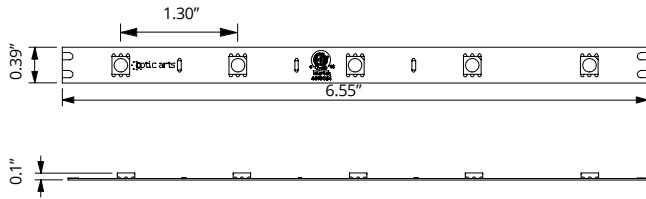

INDOOR DIMENSIONS

Width	0.40" (10.05mm)
Height	0.10" (2.33mm)
Cuttable Segment Length	6.55" (166.37mm)
Pitch Length	1.30" (33.00mm)
Max Run Length	43.00' (13106.40mm)

OUTDOOR FLEX DC® 22

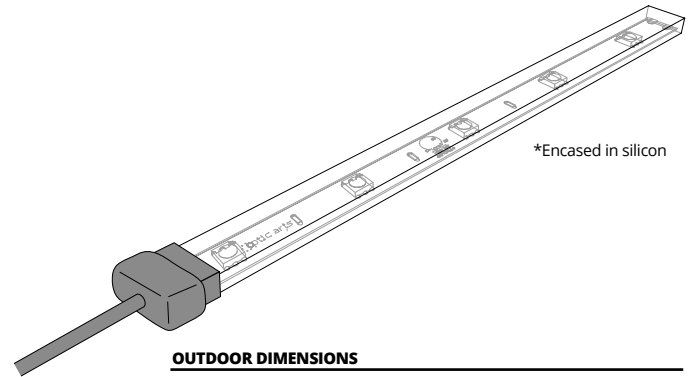
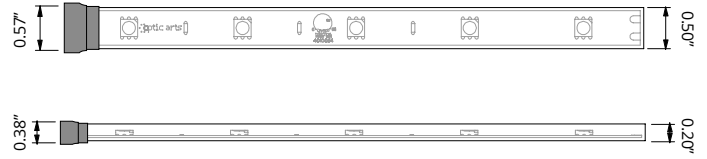

OUTDOOR DIMENSIONS

Width	0.50" (12.70mm)
Height	0.20" (5.15mm)
Width (Endcap)	0.57" (14.48mm)
Height (Endcap)	0.38" (9.65mm)
Max Run Length	43.00' (6096.00mm)

INDOOR FLEX DC® 22

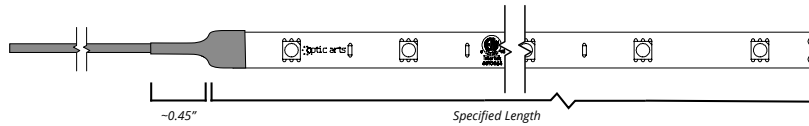

OUTDOOR FLEX DC® 22

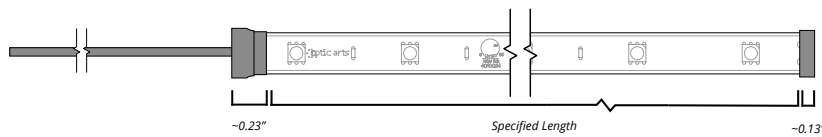

MOUNTING OPTIONS - COMPATIBLE CHANNELS

[Click to access CHANNEL ACCESSORIES CATALOGUE >](#)

KEY

DIFFUSION LEVEL:

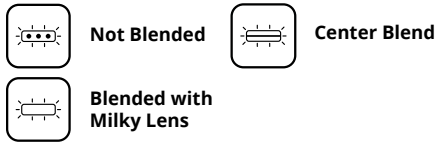

CONFIGURATION:

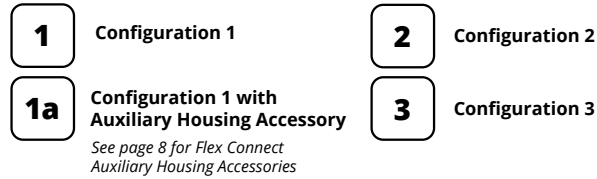

CHS-R-1208

• Click on channel titles below to access complete channel cut sheets.

SMALL CHANNELS

SMALL CHANNEL PART NUMBER BREAKDOWN:

CHANNEL	CHANNEL SIZE	CHANNEL TYPE	FINISH	LENS TYPE	LENS DIFFUSION	MOUNTING
CH-SM = Channel Small	LS = Legacy Short LT = Legacy Tall	SF = Surface RE = Recessed	SS = Satin Silver MB = Matte Black Anodized ¹ BZ = Deep Bronze Anodized ¹ WH = White Powder Coat ¹ GY = Gray Powder Coat ¹	FL = Flat GZ = Grazer	CC = Clear ⁴ CF = Frosted CM = Milky ⁴ <i>*Leave Blank for Grazer</i>	NA = Direct Surface MC = Mounting Clip ³ RC = Rotating Clip ³
			¹ : Special order finishes may increase order lead time and incur an added cost.		⁴ : Not compatible with Grazer Lens Type.	³ : Not compatible with recessed options

CH-SM-LS-RE

(Previously Known As CHS-R-1208)

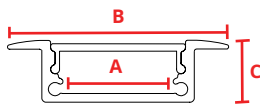

A: 0.68" (17.25mm)
B: 0.98" (25.00mm)
C: 0.34" (8.60mm)



MATERIAL	Anodized Aluminum.
DESCRIPTION	Small - Short - Recessed - Channel.
LENGTH	7 Ft.
LENS TYPES	Clear CH-SM-LN-FL-CC Frosted CH-SM-LN-FL-CF Milky CH-SM-LN-FL-CM
ACCESSORIES	Endcap CH-SM-LS-RE-FL-EC Endcap w/hole CH-SM-LS-RE-FL-ECH

CH-SM-LS-SF

(Previously Known As CHS-S-1208)

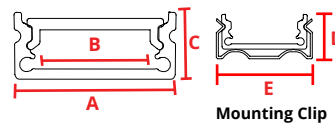

A: 0.68" (17.25mm) D: 0.40" (12.70mm)
B: 0.50" (12.59mm) E: 0.78" (19.90mm)
C: 0.34" (8.60mm)

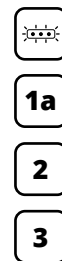

MATERIAL	Anodized Aluminum
DESCRIPTION	Small - Short - Surface - Channel.
LENGTH	7 Ft.
LENS TYPES	Clear CH-SM-LN-FL-CC Frosted CH-SM-LN-FL-CF Milky CH-SM-LN-FL-CM
ACCESSORIES	Endcap CH-SM-LS-SF-FL-EC Endcap w/hole CH-SM-LS-SF-FL-ECH Mounting Clip CH-SM-LE-MC Rotating Mounting Clip CH-SM-LE-MC-R

CH-SM-LT-RE

(Previously Known As CHS-R-1715)

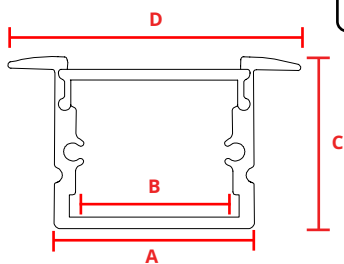

A: 0.68" (17.25mm)
B: 0.48" (12.30mm)
C: 0.59" (15.05mm)
D: 0.98" (25.00mm)



MATERIAL	Anodized Aluminum
DESCRIPTION	Small - Tall - Recessed - Channel.
LENGTH	7 Ft.
LENS TYPES	Clear CH-SM-LN-FL-CC Frosted CH-SM-LN-FL-CF Milky CH-SM-LN-FL-CM
ACCESSORIES	Endcap CH-SM-LT-RE-FL-EC Endcap w/hole CH-SM-LT-RE-FL-ECH

CH-SM-LT-SF

(Previously Known As CHS-S-1715)

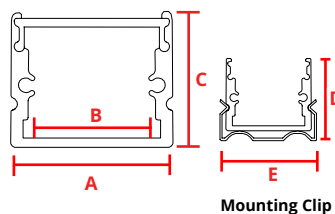

A: 0.68" (17.25mm) D: 0.66" (16.76mm)
B: 0.48" (12.30mm) E: 0.78" (19.90mm)
C: 0.59" (15.05mm)



MATERIAL	Anodized Aluminum
DESCRIPTION	Small - Tall - Surface - Channel.
LENGTH	7 Ft.
LENS TYPES	Clear CH-SM-LN-FL-CC Frosted CH-SM-LN-FL-CF Milky CH-SM-LN-FL-CM
ACCESSORIES	Endcap CH-SM-LT-SF-FL-EC Endcap w/hole CH-SM-LT-SF-FL-ECH Mounting Clip CH-SM-LE-MC Rotating Mounting Clip CH-SM-LE-MC-R

MOUNTING OPTIONS - COMPATIBLE CHANNELS

- Not Blended
 Blended w/Milky Lens
 1 Configuration 1
1a Configuration 1 with Auxiliary Housing Accessory
2 Configuration 2
3 Configuration 3

MEDIUM CHANNELS

MEDIUM CHANNEL PART NUMBER BREAKDOWN:

CHANNEL	CHANNEL SIZE	CHANNEL TYPE	FINISH	LENS TYPE	LENS DIFFUSION	MOUNTING
CH-MD = Channel Medium	LS = Legacy Short TL = Tall ⁶	SF = Surface RE = Recessed ⁴	SS = Satin Silver MB = Matte Black Anodized ⁹ BZ = Deep Bronze Anodized ⁹ WH = White Powder Coat ⁹ GY = Gray Powder Coat ⁹	FL = Flat	CC = Clear CF = Frosted CM = Milky	NA = Direct Surface MC = Mounting Clip ⁷ RC = Rotating Clip ⁷ PD = Pendant ^{7,8}
<small>4: Not available for tall channel. 5: Only available in surface channel type.</small>		<small>7: Not compatible with recessed options. 8: Not available with Lite option.</small>		<small>9: Special order finishes may increase order lead time and incur an added cost.</small>		

CH-MD-LS-SF

(Previously Known As CHW-S-2010)

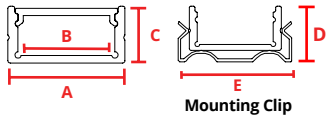

Mounting Clip

- A:** 0.93" (23.50mm) **D:** 0.48" (12.19mm)
B: 0.78" (20.00mm) **E:** 1.02" (25.80mm)
C: 0.39" (10.00mm)



1

2

3

MATERIAL

Anodized Aluminum

DESCRIPTION

Medium - Lite - Surface - Channel.

LENGTH

7 Ft.

LENS TYPES

Clear	CH-MD-LN-FL-CC
Frosted	CH-MD-LN-FL-CF
Milky	CH-MD-LN-FL-CM

ACCESSORIES

Endcap	CH-MD-LS-SF-FL-EC
Endcap w/hole	CH-MD-LS-SF-FL-ECH
Mounting Clip	CH-MD-LE-MC
Rotating Mounting Clip	CH-MD-LE-MC-R

CH-MD-LS-RE

(Previously Known As CHW-R-2010)

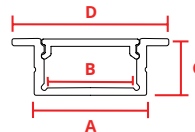

- A:** 0.93" (23.50mm)
B: 0.78" (20.00mm)
C: 0.39" (10.00mm)
D: 1.19" (30.24mm)



1

2

MATERIAL

Anodized Aluminum

DESCRIPTION

Medium - Lite - Recessed - Channel.

LENGTH

7 Ft.

LENS TYPES

Clear	CH-MD-LN-FL-CC
Frosted	CH-MD-LN-FL-CF
Milky	CH-MD-LN-FL-CM

ACCESSORIES

Endcap	CH-MD-LS-RE-FL-EC
Endcap w/hole	CH-MD-LS-RE-FL-ECH
Mounting Clip	CH-MD-LE-MC
Rotating Mounting Clip	CH-MD-LE-MC-R

CH-MD-TL-SF

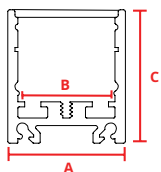

- A:** 0.90" (23.11mm)
B: 0.75" (19.05mm)
C: 1.02" (26.16mm)



1

2

3

MATERIAL

Anodized Aluminum

DESCRIPTION

Medium - Tall - Surface - Channel.

LENGTH

7 Ft.

LENS TYPES

Clear	CH-MD-LN-FL-CC
Frosted	CH-MD-LN-FL-CF
Milky	CH-MD-LN-FL-CM

ACCESSORIES

Endcap	CH-MD-TL-SF-FL-EC
Endcap w/hole	CH-MD-TL-SF-FL-ECH
Mounting Clip	CH-MC
Rotating Mounting Clip	CH-MC-R-AY
Pendant	CH-PD-KIT

MOUNTING OPTIONS - COMPATIBLE CHANNELS

- Not Blended
 Blended w/Milky Lens
 1 Configuration 1
 1a Configuration 1 with Auxiliary Housing Accessory
 2 Configuration 2
 3 Configuration 3

LARGE CHANNELS

CHANNEL PART NUMBER BREAKDOWN:

CHS	+	R	+	1208
SERIES		APPLICATION		DIMENSIONS
CHS = Slim Channel CHW = Wide Channel		S = Surface Mount R = Recessed Mount C = Corner Mount H = Hanging Mount		XXXX = W x H (mm)

CHW-S-3535

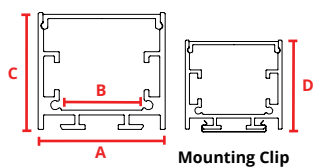

- A:** 1.39" (35.25mm)
B: 0.96" (24.50mm)
C: 1.39" (35.25mm)
D: 1.54" (39.00mm)

*Must specify for hanging or surface mount application.



MATERIAL

Anodized Aluminum



DESCRIPTION

Wide and deep surface mounted or hanging channel. Eliminates visible LED nodes for most FLEXDC products when used with a milky lens.



LENGTH

2 meter



LENS TYPES

Frosted Milky CHW-35mm-CF
Milky CHW-35mm-CM

ACCESSORIES

Endcap CHW-S-3535-EC
Endcap w/hole CHW-S-3535-ECH
Mounting Clip CHW-S-3535-MC
Hanging Hardware CHW-SH-3535-MW
Bracket Straight CHW-S-XX35-BS
Bracket 90° Flat CHW-S-XX35-B90F
Bracket 90° Raised CHW-S-XX35-B90R
End Cap for FLEX AC CHW-S-3535-ECAC
Mounting Clip for FLEX AC CHW-S-3535-MCAC
VHB Tape VHBTAPE.AC

CHW-R-4435

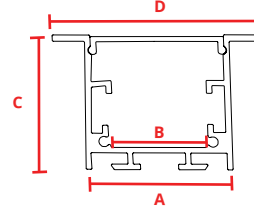

- A:** 1.39" (35.25mm)
B: 0.96" (24.50mm)
C: 1.39" (35.25mm)
D: 2.00" (51.04mm)



MATERIAL

Anodized Aluminum



DESCRIPTION

Wide and deep recessed channel. Eliminates visible LED nodes for most FLEXDC products when used with a milky lens. Can be securely and conveniently mounted with CHW-R-4435-SC spring clip.



LENGTH

2 meter



LENS TYPES

Frosted Milky CHW-35mm-CF
Milky CHW-35mm-CM

ACCESSORIES

Endcap CHW-R-4435-EC
Endcap w/hole CHW-R-4435-ECH
Mounting Clip CHW-R-4435-SC
Bracket Straight CHW-S-XX35-BS
Bracket 90° Flat CHW-S-XX35-B90F
Bracket 90° Raised CHW-S-XX35-B90R
End Cap for FLEX AC CHW-R-4435-ECAC
Mounting Clip for FLEX AC CHW-R-4435-MCAC
VHB Tape VHBTAPE.AC

CORNER CHANNELS

CHS-C-1919

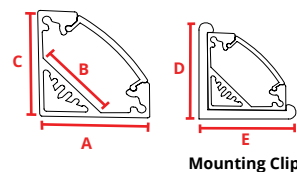

- A:** 0.73" (18.50mm) **D:** 0.82" (20.82mm)
B: 0.48" (12.20mm) **E:** 0.82" (20.82mm)
C: 0.73" (18.50mm)



MATERIAL

Anodized Aluminum



DESCRIPTION

Slim corner mount channel.



LENGTH

2 meter



LENS TYPES

Clear CHS-12mm-CC
Frosted CHS-12mm-CF
Milky CHS-12mm-CM

ACCESSORIES

Endcap CHS-C-1919-EC
Endcap w/hole CHS-C-1919-ECH
Mounting Clip CHS-C-1919-MC

CHS-C-1616

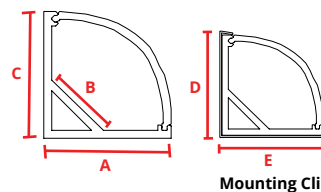

- A:** 0.63" (16.00mm) **D:** 0.70" (17.78mm)
B: 0.39" (10.00mm) **E:** 0.70" (17.78mm)
C: 0.63" (16.00mm)



MATERIAL

Anodized Aluminum



DESCRIPTION

Slim corner mount channel with rounded lens.



LENGTH

2 meter



LENS TYPES

Frosted Milky CHS-C-1616-CF
Milky CHS-C-1616-CM

ACCESSORIES

Endcap CHS-C-1616-EC
Endcap w/hole CHS-C-1616-ECH
Mounting Clip CHS-C-1616-MC

MOUNTING OPTIONS - COMPATIBLE CHANNELS

- Not Blended
 Blended w/Milky Lens
 1 Configuration 1
1a Configuration 1 with Auxiliary Housing Accessory
2 Configuration 2
3 Configuration 3

CORNER CHANNELS

CHW-C-3030

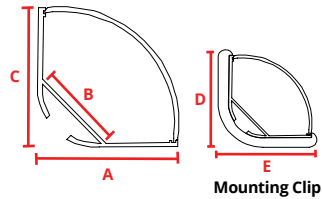

A: 1.18" (30.00mm) **D:** 1.29" (32.77mm)
B: 0.78" (20.20mm) **E:** 1.29" (32.77mm)
C: 1.18" (30.00mm)



MATERIAL
Anodized Aluminum



DESCRIPTION
45 degree channel with rounded lens.



LENGTH
2 meter



LENS TYPES
 Clear CHW-C-3030-CC
 Frosted CHW-C-3030-CF
 Milky CHW-C-3030-CM

ACCESSORIES

Endcap CHW-C-3030-EC
Endcap w/hole CHW-C-3030-ECH
Mounting Clip CHW-C-3030-MC

CHW-C-3030S

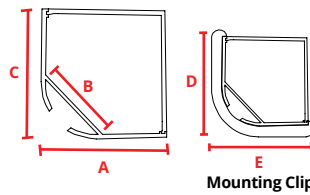

A: 1.18" (30.00mm) **D:** 1.29" (32.77mm)
B: 0.78" (20.20mm) **E:** 1.29" (32.77mm)
C: 1.18" (30.00mm)



MATERIAL
Anodized Aluminum



DESCRIPTION
45 degree channel with square lens.



LENGTH
2 meter



LENS TYPES
 Clear CHW-C-3030S-CC
 Frosted CHW-C-3030S-CF
 Milky CHW-C-3030S-CM

ACCESSORIES

Endcap CHW-C-3030S-EC
Endcap w/hole CHW-C-3030S-ECH
Mounting Clip CHW-C-3030S-MC

SPECIALTY CHANNELS

CHS-S-1922R

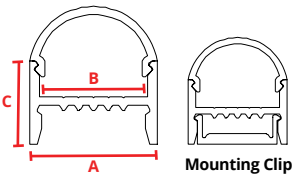

A: 0.77" (19.50mm)
B: 0.65" (16.50mm)
C: 0.86" (21.80mm)



MATERIAL
Anodized Aluminum



DESCRIPTION
Slim surface mounted channel with rounded wrap around lens. Mounting clip is fully concealed within fixture base.



LENGTH
2 meter



LENS TYPES
Milky CHW-S-1922R-CM

ACCESSORIES

Endcap CHS-S-1922R-EC
Endcap w/hole CHS-S-1922R-ECH
Mounting Clip CHS-S-1922R-MC

CHW-S-2623

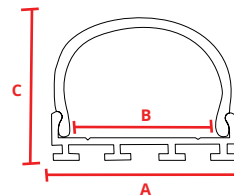

A: 1.03" (26.20mm)
B: 0.80" (20.35mm)
C: 0.89" (22.76mm)



MATERIAL
Anodized Aluminum



DESCRIPTION
Surface mounted channel with wrap around lens.



LENGTH
2 meter



LENS TYPES
Milky CHW-S-2623-CM

ACCESSORIES

Endcap CHW-S-2623-EC
Endcap w/hole CHW-S-2623-ECH

CHS-S-1922S

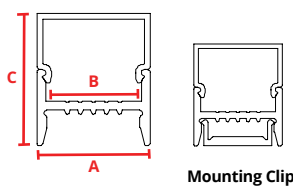

A: 0.77" (19.50mm)
B: 0.65" (16.50mm)
C: 0.86" (21.80mm)



MATERIAL
Anodized Aluminum



DESCRIPTION
Slim surface mounted channel with square wrap around lens. Mounting clip is fully concealed within fixture base.



LENGTH
2 meter



LENS TYPES
Milky CHW-S-1922S-CM

ACCESSORIES

Endcap CHS-S-1922S-EC
Endcap w/hole CHS-S-1922S-ECH
Mounting Clip CHS-S-1922S-MC

CHW-S/H-2027

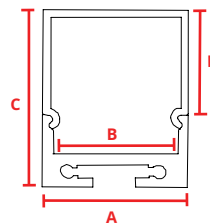

A: 0.79" (20.30mm)
B: 0.66" (16.70mm)
C: 1.06" (27.00mm)
D: 0.76" (19.50mm)



MATERIAL
Anodized Aluminum



DESCRIPTION
Small surfaced mounted or hanging channel with wrap around lens.



LENGTH
2 meter



LENS TYPES
 Clear CHW-SH-2027-CC
 Frosted CHW-SH-2027-CF
 Milky CHW-SH-2027-CM

ACCESSORIES

Endcap CHW-SH-2027-EC
End Cap w/hole CHW-SH-2027-ECH
Hanging Hardware CHW-SH-MW
Bracket Straight CHW-SH-BS
Bracket 90° Flat CHW-SH-B90F
Bracket 90° Raised CHW-SH-B90R

**Must specify for hanging or surface mount application.*

MOUNTING OPTIONS - COMPATIBLE CHANNELS

- Not Blended
 Blended w/Milky Lens
 1 Configuration 1
 1a Configuration 1 with Auxiliary Housing Accessory
 2 Configuration 2
 3 Configuration 3

SPECIALTY CHANNELS

CHW-S/H-3561

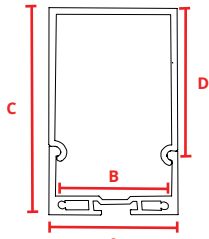

A: 1.38" (35.00mm) **C:** 2.43" (61.70mm)
B: 1.24" (31.40mm) **D:** 1.57" (39.90mm)



MATERIAL

Anodized Aluminum



DESCRIPTION

Large surface mounted or hanging channel with wrap around lens.



LENGTH

2 meter



LENS TYPES

Milky CHW-SH-3561-CM

ACCESSORIES

Endcap CHW-SH-3561-EC
End Cap w/hole CHW-SH-3561-ECH
Hanging Hardware CHW-SH-MW
Bracket Straight CHW-SH-BS
Bracket 90° Flat CHW-SH-B90F
Bracket 90° Raised CHW-SH-B90R

*Must specify for hanging or surface mount application.

CHW-S/H-3030

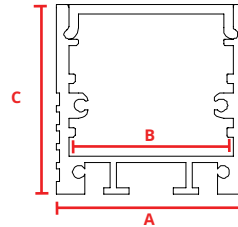

A: 1.18" (30.00mm)
B: 1.01" (25.60mm)
C: 1.18" (30.00mm)



MATERIAL

Anodized Aluminum



DESCRIPTION

Wide and deep surface mounted or hanging channel with flat lens for even blending.



LENGTH

2 meter

LENS TYPES

Milky CHW-SH-3030-CM

ACCESSORIES

Endcap CHW-SH-3030-EC
Endcap w/hole CHW-SH-3030-ECH
Hanging Hardware CHW-SH-MW
Bracket Straight CHW-SH-BS
Bracket 90° Flat CHW-SH-B90F
Bracket 90° Raised CHW-SH-B90R
End Cap for FLEX AC CHW-SH-3030-ECAC
Mounting Clip for FLEX AC CHW-SH-3030-MCAC
VHB Tape VHBTAPE.AC

*Must specify for hanging or surface mount application.

CHW-S/H-7532

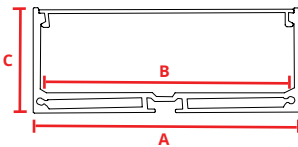

A: 2.95" (75.00mm)
B: 2.52" (64.00mm)
C: 1.26" (32.00mm)



MATERIAL

Anodized Aluminum



DESCRIPTION

Wide surface mounted or hanging channel with flat lens.



LENGTH

2 meter



LENS TYPES

Frosted CHW-SH-7532-CF

ACCESSORIES

Endcap CHW-SH-7532-EC
Endcap w/hole CHW-SH-7532-ECH
Hanging Hardware CHW-SH-MW
Bracket Straight CHW-SH-BS
Bracket 90° Flat CHW-SH-B90F
Bracket 90° Raised CHW-SH-B90R

*Must specify for hanging or surface mount application.

CHC-S-1921

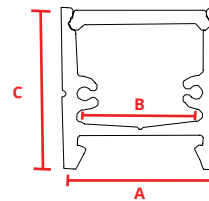

A: 0.76" (19.43mm)
B: 0.55" (14.09mm)
C: 0.84" (21.43mm)



MATERIAL

Anodized Aluminum



DESCRIPTION

Surface mount channel with flat lens. Mounts to ferrous and non-ferrous surfaces using magnets with no visible fasteners once mounted.



LENGTH

2 meter

LENS TYPES

Milky CHC-S-1921-CM

ACCESSORIES

Anodized Aluminum Endcap CHC-S-1921-EC
Anodized Aluminum Endcap w/hole CHC-S-1921-ECH
Channel Mounted Magnet CHC-S-1921-MA
Wall Mounted Magnet CHC-S-1921-M
1" Mounting Plate CHC-S-1921-B1

CHSP-S-1618

Fits IP40 FLEX DC® Only

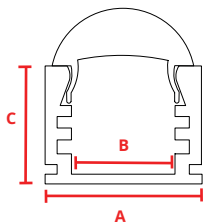

A: 0.63" (16.00mm) **C:** 0.49" (11.90mm)
B: 0.40" (10.16mm)



MATERIAL

Anodized Aluminum



DESCRIPTION

Includes an aluminum insert that allows selection between (4) different beamspreads based on the position of the insert.



LENGTH

2 meter

LENS TYPES

Focusing Lens CHSP-S-1618-CFL

ACCESSORIES

Endcap CHSP-S-1618-EC
Endcap w/hole CHSP-S-1618-ECH
Mounting Clip CHSP-S-1618-MC

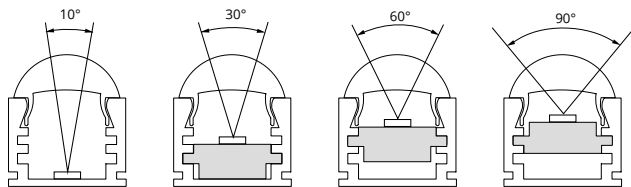

ACCESSORIES

LC-I2P-M

Indoor Lead Connector
(Male)

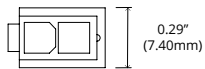
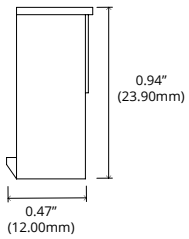
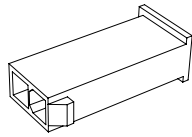

LC-I2P-F

Indoor Lead Connector
(Female)

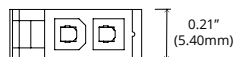
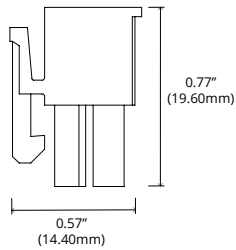
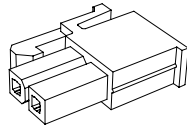

LC-O2P-F

Outdoor Lead Connector
(Female)

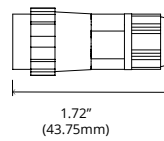
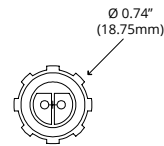
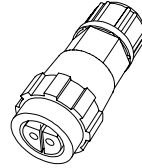

LC-O2P-M

Outdoor Lead Connector
(Male)

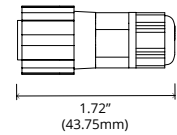
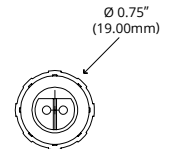
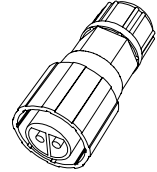

FLEX.ZIP

Strain Relief Clip

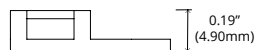
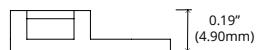
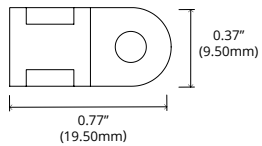
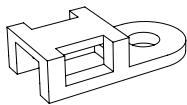

FLEXMNT.SIL.INT

Indoor Mounting Clip

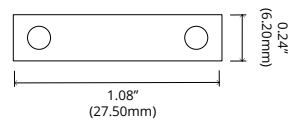
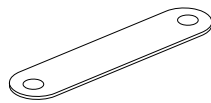

FLEXMNT.SIL.EXT12

Outdoor Mounting Clip

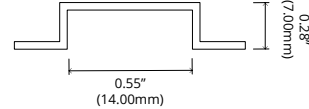
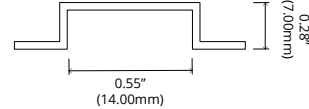
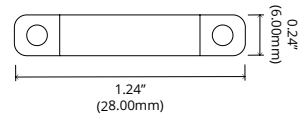
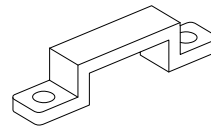

ACCESSORIES

FLEXDC.PFC.02.10

Field installed FLEX Connect® power feed
- 2 Conductor for 10mm Strip

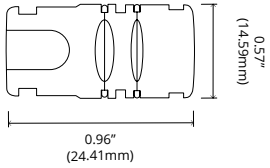

Fits in all channel **except**:

- CHS-R-1208
- CHS-R-1715
- CHS-S-1208
- CHS-S-1715
- CHS-C-1919
- CHS-C-1616
- CHC-S-1921
- CHSP-R-2970
- CHSP-S-1618
- CHSP-STEP-8142

FLEXDC.BSC.02.10

Field installed FLEX Connect® butt splice -
2 Conductor for 10mm Strip

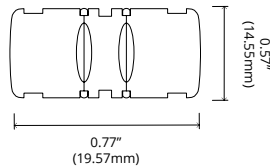

Fits in all channel **except**:

- CHS-R-1208
- CHS-R-1715
- CHS-S-1208
- CHS-S-1715
- CHS-C-1919
- CHS-C-1616
- CHC-S-1921
- CHSP-R-2970
- CHSP-S-1618
- CHSP-STEP-8142

LO-18G-2C-W-72

6' wire lead for FLEX Connect®
(not in-wall rated)

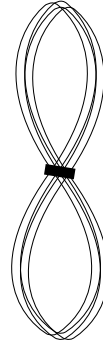

LP-18G-2C-W-72

6' Plenum rated wire lead for
FLEX Connect®

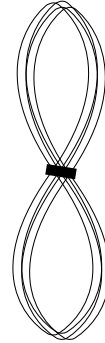

LO-18G-2C-W-SP

1000' spool of wire for
FLEX Connect® (not in-wall rated)

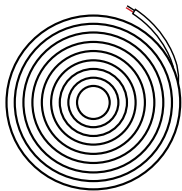

LP-18G-2C-W-SP

500' box of Plenum rated wire for
FLEX Connect®

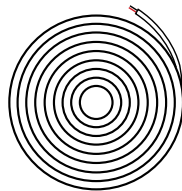

CONFIGURATION TYPES

① FLEX cut to length with FLEX Connect® Power Feeds for Field Termination, Channel uncut for field cutting

- Specify **FLEXConfig-1**
- Specify FLEX type and channel type
- FLEX factory cut to length, but not terminated
- One FLEX Connect® power feed connector and 6' lead provided per FLEX run
 - Uncut rolls of lead wire can also be provided (see page 8 for part #)
- Channel shipped uncut for field cutting.
- Specify number of butt splices (not shown - see page 8)
- IP68 not available in **FLEXConfig-1**
- JA8 2016 not available in **FLEXConfig-1**
- FLEXConfig-1** is quick ship if run lengths are provided at time of order. Take offs, if needed, will add lead time.
- The below channels are **NOT** compatible with FLEX Connect®:
 - Slim:**
 - CHS-R-1208
 - CHS-R-1715
 - CHS-S-1208
 - CHS-S-1715
 - CHS-C-1616
 - CHC-S-1921
 - Specialty:**
 - CHSP-R-2970
 - CHSP-S-1618
 - CHSP-STEP-8142

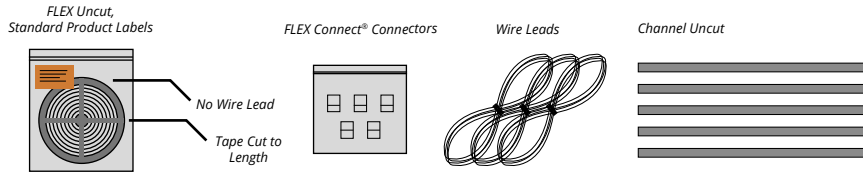

② Cut To Length With Soldered Leads, Assemble On-Site^{1, 2, 3}

- Specify **FLEXConfig-2**
- Specify FLEX type and channel type
- Specify run lengths
- IP68 only available in **FLEXConfig-2**
- If no config is specified, and run lengths are provided, **FLEXConfig-2** will be used

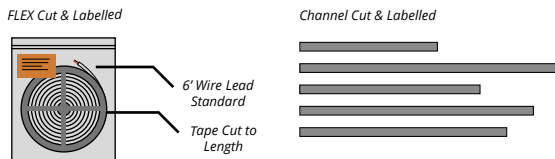

③ Pre-Assembled Factory Finished Fixtures^{1, 2}

- Specify **FLEXConfig-3**
- Fully assembled fixture
- ETL stamped and listed as a fixture
- 6.50' max length
- Standard 6' power lead unless otherwise specified
- The below channels **CANNOT** be factory assembled:
 - Slim:**
 - CHS-R-1208
 - CHS-R-1715
 - Wide:**
 - CHW-R-2010
 - CHW-S-2027
 - CHW-S-7532
 - CHW-S-2623
 - CHW-S-3030
 - CHW-S-3561

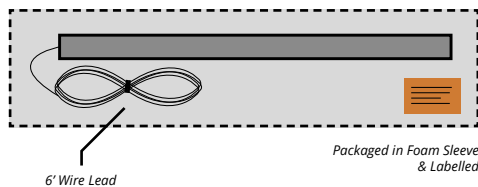

NOTES:

- Due to the nature of the FLEX DC® product, specific lengths may not fall exactly on a cutting point. In this case, Optic Arts® will always cut to the smaller dimension unless otherwise specified.
- Unless otherwise specified, channel is cut 15mm longer than FLEX DC®.
- Some on-site assembly required. See installation guides for details.

COMPATIBLE DRIVERS

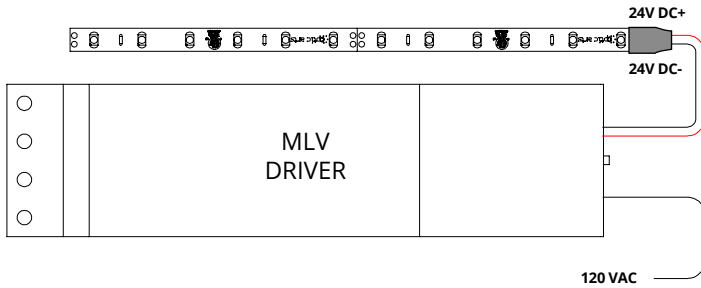

MLV (MLV)

PART	DESCRIPTION
ML10S24VDC	10W 120VAC DIMMABLE DRIVER
ML20S24VDC	20W 120VAC DIMMABLE DRIVER
ML35S24VDC	35W 120VAC DIMMABLE DRIVER
ML35S24VDC-277	35W 277VAC DIMMABLE DRIVER
ML40S24VDC	40W 120VAC DIMMABLE DRIVER
ML50S24VDC	50W 120VAC DIMMABLE DRIVER
ML50S24VDC-277	50W 277VAC DIMMABLE DRIVER
ML60S24VDC	60W 120VAC DIMMABLE DRIVER
ML75S24VDC	75W 120VAC DIMMABLE DRIVER
ML75S24VDC-277	75W 277VAC DIMMABLE DRIVER
ML96S24VDC	96W 120VAC DIMMABLE DRIVER
ML96S24VDC-277	96W 120VAC DIMMABLE DRIVER
EM2-200S24DC	200W 120VAC DIMMABLE DRIVER, 2 96W CIRCUITS
EM3-300S24DC	300W 120VAC DIMMABLE DRIVER, 3 96W CIRCUITS
EM2-200S24DC-277	200W 120VAC DIMMABLE DRIVER, 2 96W CIRCUITS
EM3-300S24DC-277	288W 120VAC DIMMABLE DRIVER, 3 96W CIRCUITS

DIMENSIONS

10W-50W	H 2.11"; W 7.38"; D 1.60"
60W-96W	H 3.93"; W 8.13"; D 1.59"
200-300W	H 5.69"; W 10.29"; D 3.13"

DIMMING PERFORMANCE

MLV DRIVER Dims to 20% on most MLV dimmers

NOTE: Must be loaded between 75%-100% of rated load to maintain FLEX DC[®] warranty

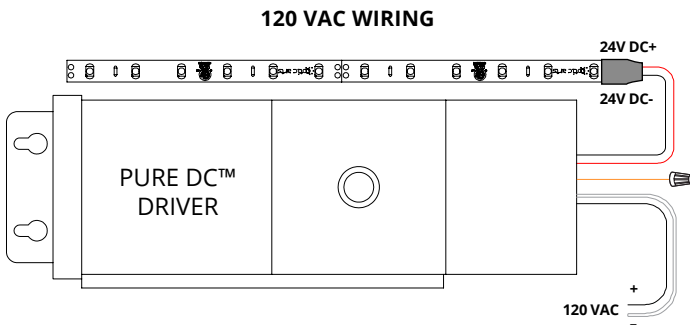

PURE DC[™] MLV (PDC)

PART	DESCRIPTION
PDC.40.24	40W 120/277VAC PURE DC [™] MLV DIMMABLE DRIVER
PDC.96.24	96W 120/277VAC PURE DC [™] MLV DIMMABLE DRIVER

DIMENSIONS

40W	L 14.25"; W 3.00"; H 2.88"
96W	L 14.75"; W 4.31"; H 4.81"

DIMMING PERFORMANCE

PURE DC[™] DRIVER Dims to 0.1% on most MLV dimmers

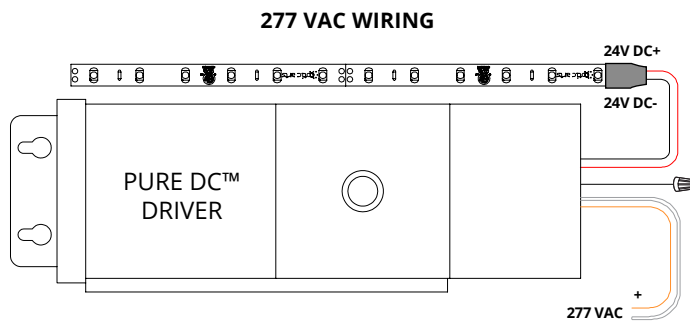

COMPATIBLE DRIVERS

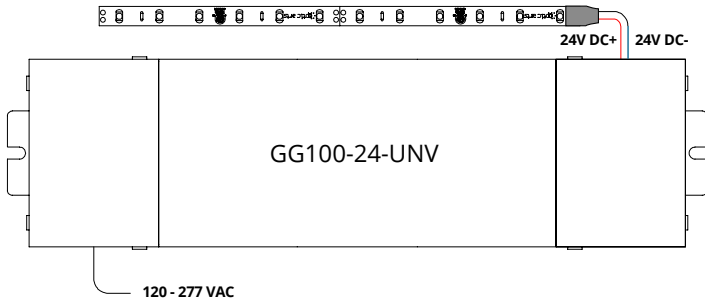

ELECTRONIC DRIVER - NON-DIM (ND)

PART	DESCRIPTION
GG100E-24-UNV	96W 120-277VAC ELECTRONIC DRIVER
DIMENSIONS	
ELECTRONIC DRIVER	H 3.00"; W 11.46"; D 1.30"
DIMMING PERFORMANCE	
ELECTRONIC DRIVER	Non-Dim

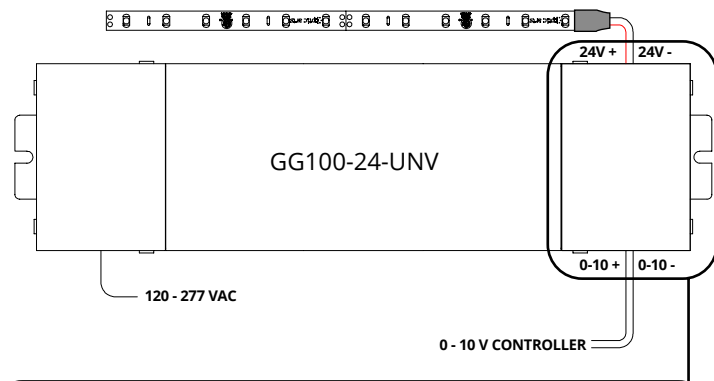

ELECTRONIC DRIVER W/0-10V MODULE (010)

PART	DESCRIPTION
GG100E-24-UNV-010V	96W 120-277VAC ELECTRONIC DRIVER WITH 0-10V DIMMING MODULE (SINK)
DIMENSIONS	
ELECTRONIC DRIVER - 0-10V	H 3.00"; W 11.46"; D 1.30"
DIMMING PERFORMANCE	
ELECTRONIC DRIVER - 0-10V	Dims below 1% on most 0-10V dimmers

FIELD INSTALLED IN LOW VOLTAGE WIRING COMPARTMENT

- Install DIM-010V Module in low voltage wiring compartment.
- Max number of 25 modules on one dimmer. Consult dimmer datasheet for maximum device limitation of a specific controller.

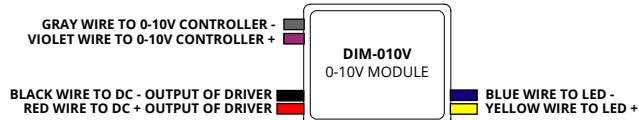

COMPATIBLE DRIVERS

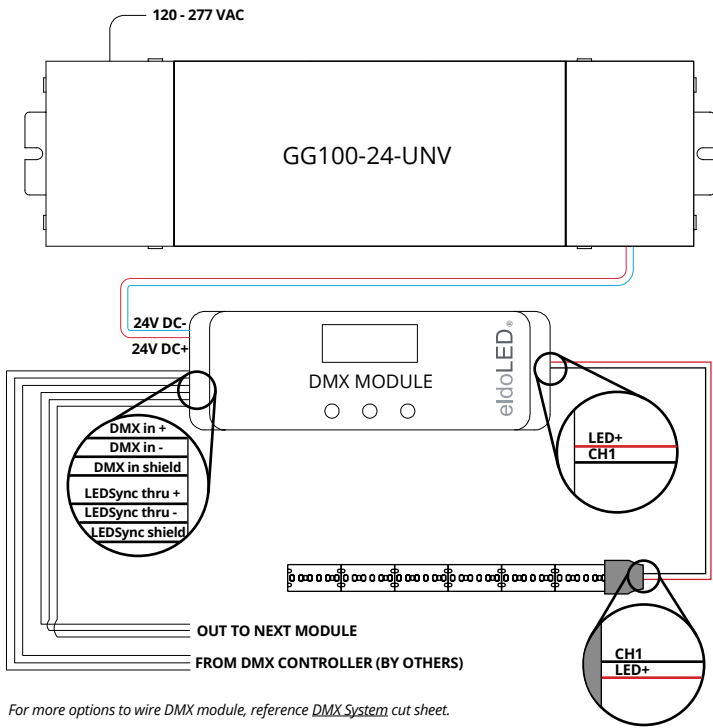

For more options to wire DMX module, reference [DMX System cut sheet](#).

ELECTRONIC DRIVER W/DMX MODULE (DMX)

PART	DESCRIPTION
GG100E-24-UNV-DMX	96W 120-277VAC ELECTRONIC DRIVER WITH eldoLED DMX DIMMING MODULE

DIMENSIONS

96W	H 3.00"; W 11.46"; D 1.30"
DMX MODULE	H 1.97"; W 6.02"; D 0.91"

*Must be installed in UL box (by others)

DIMMING PERFORMANCE

ELECTRONIC DRIVER - DMX MODULE	Dims to 0.1% on most DMX systems
--------------------------------	----------------------------------

COMPATIBLE DRIVERS

DIMMER WITH NEUTRAL

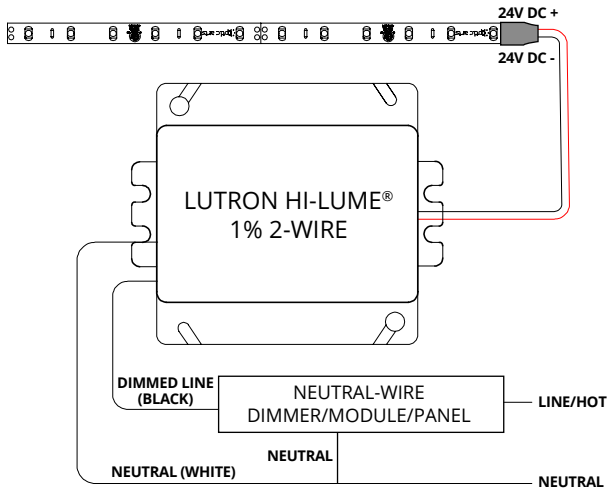

DIMMER WITHOUT NEUTRAL

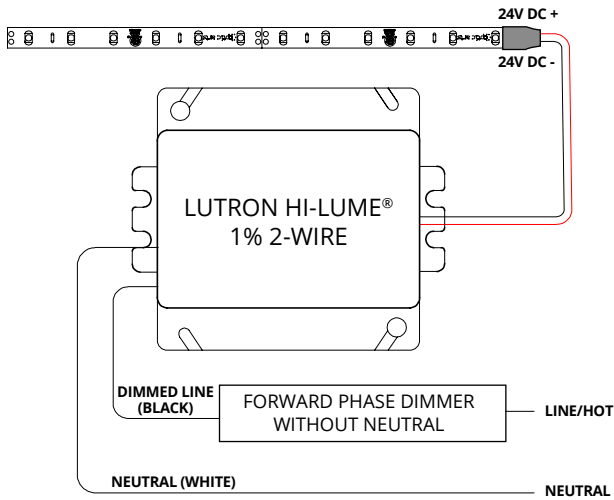

LUTRON HI-LUME® 1% 2-WIRE: 2-WIRE CONTROL FORWARD PHASE



PART	DESCRIPTION
LTEA4U1UKL-CV240	5-40W, 120VAC, 2-WIRE FORWARD PHASE DRIVER
DIMENSIONS	
LUTRON HI-LUME® 1% 2-WIRE	H 4.00"; W 4.89"; D 2.62"
DIMMING PERFORMANCE	
LUTRON HI-LUME® 1% 2-WIRE	Dims to 1% with compatible Lutron controls

COMPATIBLE DRIVERS

3-WIRE

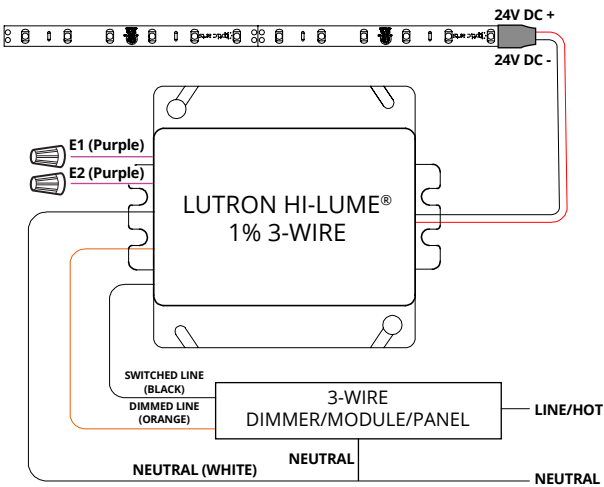

ECOSYSTEM

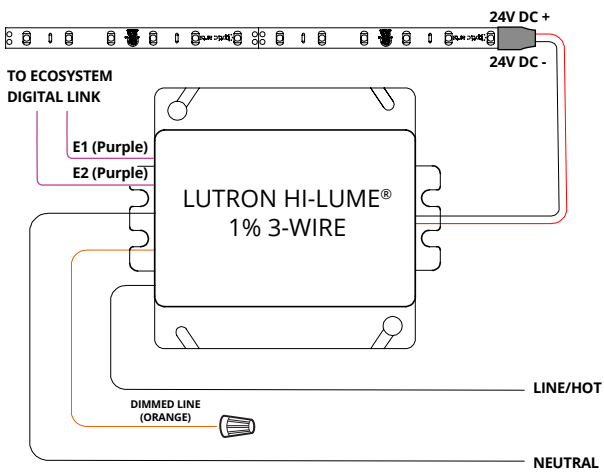

LUTRON HI-LUME® 1%: 3-WIRE/ECOSYSTEM



PART	DESCRIPTION
L3DA4U1UKL-CV240	5-40W, 120-277VAC, 3-WIRE/ECOSYSTEM DRIVER

DIMENSIONS	
HI-LUME® 1%	H 4.00"; W 4.89"; D 2.62"

DIMMING PERFORMANCE	
LUTRON HI-LUME® 1% 3-WIRE/ ECOSYSTEM	Dims to 1% with compatible Lutron controls

COMPATIBLE DRIVERS

3-WIRE

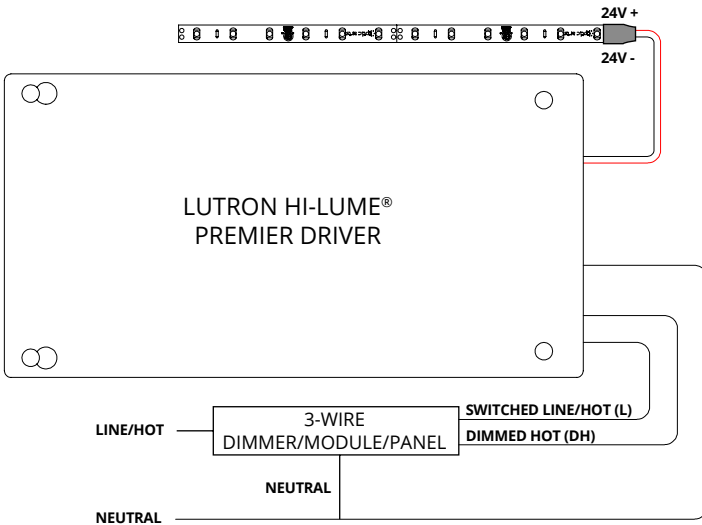

ECOSYSTEM

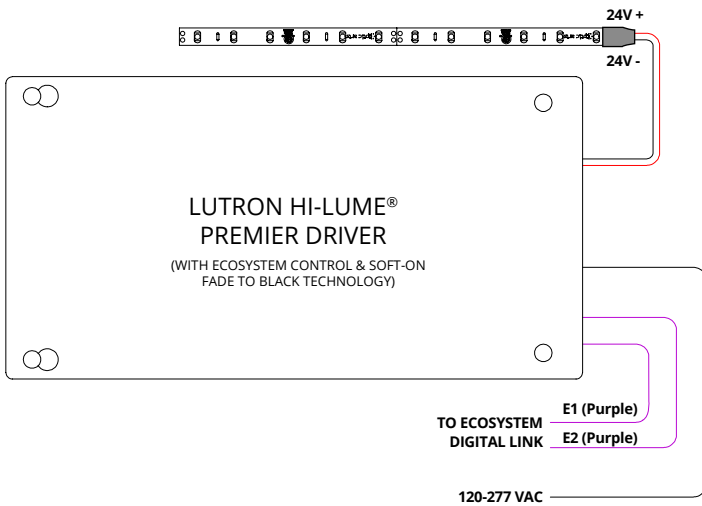

LUTRON HI-LUME® PREMIER: 3-WIRE/ECOSYSTEM



PART	DESCRIPTION
L3D0-96W24V-U	2-96W, 120-277VAC, 3-WIRE/ECOSYSTEM DRIVER

DIMENSIONS	
HI-LUME® PREMIER	H 5.5"; W 10.5"; D 2.0"

DIMMING PERFORMANCE	
LUTRON HI-LUME® PREMIER	Dims to 0.1% with compatible Lutron controls
<i>NOTE: Lutron soft-on, fade to black technology available with Ecosystem Digital Control only.</i>	