

## Features

Kurba Medium Dome Horizontal is a direct view, energy efficient and flexible LED strip suitable for wet locations capable of horizontal/side bends up to 2.5" radius. Built with robust factory made power feeds or joiners, Kurba Medium Dome Horizontal mounts to a specifically designed aluminum extruded channel.

### Applications

Outdoor wet location

### Operating Voltage

24VDC

### Operating Temperature

-40°F to 131°F (-40°C to 55°C)

### Average Life

50,000 hours

### Dimming

Low voltage dimmer and class 2 dimming power supply required

### Approvals

Class 2 wet listed, IP67

### Warranty

3 years



## Technical Information

Model	KBM-D-H	CCT INFO / LUMEN MULTIPLIER	
LEDs/ft	22	Color Temperature	Multiplier (ref. -3000K)
Light Output at 3000K	134 lm/ft	2200K	0.98
Average Power Consumption at 4'	3.7 W/ft	2400K	1.00
Ordering Increment	3.28"	2700K	1.01
Maximum Run Length (In Series)	25 ft	3000K	1.00
		3500K	1.08
		4000K	1.04

## Constraints

### Bend Direction

Bend LED in these positions only to avoid damage

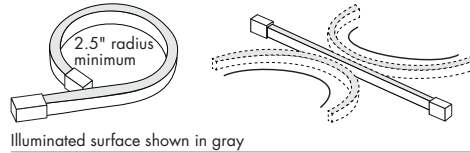

### Prohibited Bends

Twisting or bending LED in these positions will cause damage

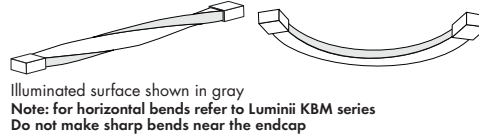

Note: for horizontal bends refer to Luminii KBM series  
Do not make sharp bends near the endcap

## Power Feed Locations

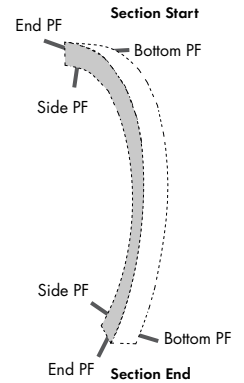

## Section Start/End Power Feed Options

### Injection Molded End Cap (IEC)

### Injection Molded Bottom Power Feed (IBPF)

### Injection Molded End Power Feed (IEPF)

### Injection Molded Side Power Feed (ISPF)

### Anti-Wicking Ferrule

Included on every power feed wire. For protection against water ingress from inside of wire. IEC shown for reference.

## Ordering Code

MODEL	CCT	SECTION START	SECTION END	ACTUAL LENGTH
KBM-D-H - Kurba Medium, Domed, Horizontal Bend	22K - 2200K 24K - 2400K 27K - 2700K 30K - 3000K 35K - 3500K 40K - 4000K	IEC - Injection Molded End cap <sup>1</sup> IEPF - Injection Molded End power feed (9' wire lead) <sup>1</sup> IBPF - Injection Molded Bottom power feed (9' wire lead) <sup>1</sup> ISPF - Injection Molded Side power feed (9' wire lead) <sup>1, 2</sup>	IEC - Injection Molded End cap <sup>1</sup> IEPF - Injection Molded End power feed (9' wire lead) <sup>1</sup> IBPF - Injection Molded Bottom power feed (9' wire lead) <sup>1</sup> ISPF - Injection Molded Side power feed (9' wire lead) <sup>1, 2</sup>	See Power Consumption table on page 3 for available lengths.

1 - 6-8 weeks lead time. Kurba injected-molded orders are non-cancellable. IEPF, IBPF, ISPF cannot be mixed and matched from Start to End except with IEC.  
2 - ISPF Side power feeds selected for both Section Start and End will be located on the same side of the strip.

**Mounting Accessories & Optional Connectors**

**MB-KBM-F-H-ST**

Mounting Bracket with Grip

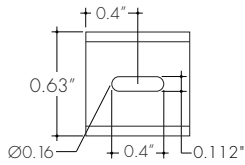
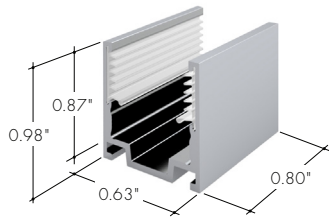

Aluminum mounting bracket providing grip. For use with light strip mounted to the ceiling. 1 recommended every 8 in.

**MC-NFS-KBM-F-H-78**

Mounting Channel with Grip, 78"

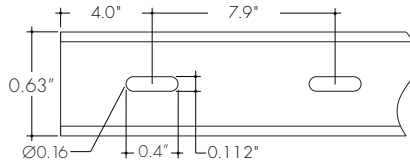
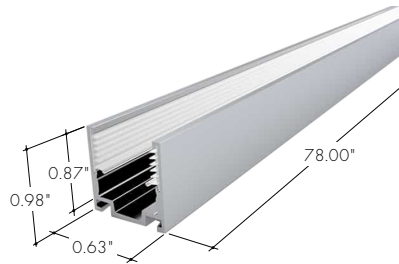

Aluminum mounting channel providing grip. For use with light strip mounted to the ceiling.

**MC-FS-KBM-F-H-78**

Flanged Mounting Channel with Grip, 78"

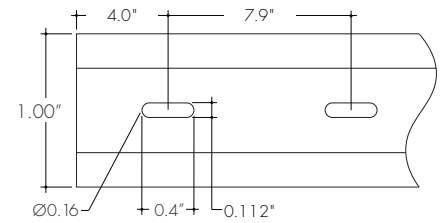
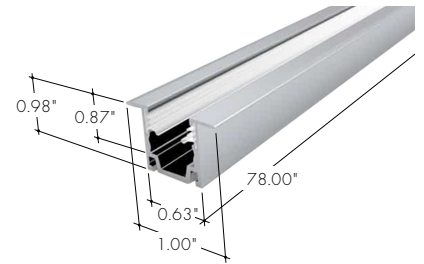

Flanged aluminum mounting channel providing grip. For use with light strip mounted to the ceiling.

**MC-BS-KBM-F-H-38**

Bendable Mounting Channel with Grip, 38"

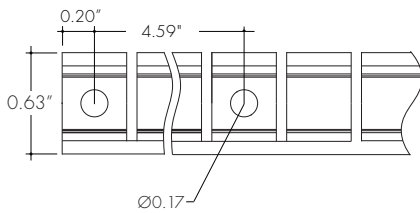
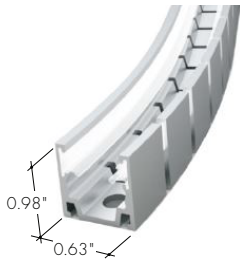

Bendable aluminum mounting channel providing grip. For use with light strip mounted to the ceiling.

**LVSP-WET**

Splice Box

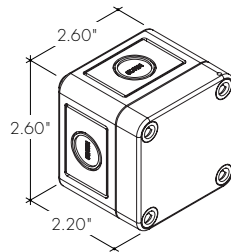

Wet rated, low voltage splice box, gray.

**LVSP-WET-CM**

Connector

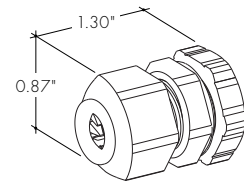

Low voltage splice box wet cable management, gray.

## Power Consumption Per Fixture Length

Based on operation with PSD series of power supplies. Use Actual Length for Order Code Entry  
 Tolerance for Actual Lengths less than 6 ft is +/- 0.2", Actual Lengths between 6 ft and 16 ft is +/- 0.3", and Actual Lengths greater than 16 ft is +/- 0.6"

Nominal Length (in)	Actual Length (in)				Nominal Length (in)	Actual Length (in)				Nominal Length (in)	Actual Length (in)			
	W	IEPF IEPF	IEC IEPF	IEC IBPF ISPF		W	IEPF IEPF	IEC IEPF	IEC IBPF ISPF		W	IEPF IEPF	IEC IEPF	IEC IBPF ISPF
4	-	-	-	-	112	34.1	<b>111.9</b>	<b>111.8</b>	<b>111.7</b>	220	67.1	<b>220.2</b>	<b>220.1</b>	<b>220</b>
7	2.1	<b>7</b>	<b>6.8</b>	<b>6.7</b>	115	35.1	<b>115.2</b>	<b>115.1</b>	<b>115</b>	223	68.1	<b>223.5</b>	<b>223.4</b>	<b>223.2</b>
10	3.1	<b>10.2</b>	<b>10.1</b>	<b>10</b>	(10 ft) 118	36.1	<b>118.5</b>	<b>118.4</b>	<b>118.3</b>	(19 ft) 227	69.1	<b>226.8</b>	<b>226.6</b>	<b>226.5</b>
(1 ft) 14	4.1	<b>13.5</b>	<b>13.4</b>	<b>13.3</b>	122	37.1	<b>121.8</b>	<b>121.7</b>	<b>121.5</b>	230	70.1	<b>230</b>	<b>229.9</b>	<b>229.8</b>
17	5.1	<b>16.8</b>	<b>16.7</b>	<b>16.6</b>	125	38.1	<b>125.1</b>	<b>124.9</b>	<b>124.8</b>	233	71.1	<b>233.3</b>	<b>233.2</b>	<b>233.1</b>
20	6.1	<b>20.1</b>	<b>20</b>	<b>19.8</b>	128	39.1	<b>128.3</b>	<b>128.2</b>	<b>128.1</b>	237	72.1	<b>236.6</b>	<b>236.5</b>	<b>236.4</b>
(2 ft) 23	7.1	<b>23.4</b>	<b>23.2</b>	<b>23.1</b>	(11 ft) 132	40.1	<b>131.6</b>	<b>131.5</b>	<b>131.4</b>	(20 ft) 240	73.1	<b>239.9</b>	<b>239.8</b>	<b>239.7</b>
27	8.1	<b>26.6</b>	<b>26.5</b>	<b>26.4</b>	135	41.1	<b>134.9</b>	<b>134.8</b>	<b>134.7</b>	243	74.1	<b>243.2</b>	<b>243.1</b>	<b>242.9</b>
30	9.1	<b>29.9</b>	<b>29.8</b>	<b>29.7</b>	138	42.1	<b>138.2</b>	<b>138.1</b>	<b>137.9</b>	246	75.1	<b>246.5</b>	<b>246.3</b>	<b>246.2</b>
33	10.1	<b>33.2</b>	<b>33.1</b>	<b>33</b>	141	43.1	<b>141.5</b>	<b>141.4</b>	<b>141.2</b>	250	76.1	<b>249.7</b>	<b>249.6</b>	<b>249.5</b>
(3 ft) 36	11.1	<b>36.5</b>	<b>36.4</b>	<b>36.2</b>	(12 ft) 145	44.1	<b>144.8</b>	<b>144.6</b>	<b>144.5</b>	(21 ft) 253	77.1	<b>253</b>	<b>252.9</b>	<b>252.8</b>
40	12.1	<b>39.8</b>	<b>39.6</b>	<b>39.5</b>	148	45.1	<b>148</b>	<b>147.9</b>	<b>147.8</b>	256	78.1	<b>256.3</b>	<b>256.2</b>	<b>256.1</b>
43	13.1	<b>43</b>	<b>42.9</b>	<b>42.8</b>	151	46.1	<b>151.3</b>	<b>151.2</b>	<b>151.1</b>	260	79.1	<b>259.6</b>	<b>259.5</b>	<b>259.3</b>
46	14.1	<b>46.3</b>	<b>46.2</b>	<b>46.1</b>	(13 ft) 155	47.1	<b>154.6</b>	<b>154.5</b>	<b>154.4</b>	(22 ft) 263	80.1	<b>262.9</b>	<b>262.7</b>	<b>262.6</b>
(4 ft) 50	15.1	<b>49.6</b>	<b>49.5</b>	<b>49.4</b>	158	48.1	<b>157.9</b>	<b>157.8</b>	<b>157.6</b>	266	81.1	<b>266.1</b>	<b>266</b>	<b>265.9</b>
53	16.1	<b>52.9</b>	<b>52.8</b>	<b>52.7</b>	161	49.1	<b>161.2</b>	<b>161</b>	<b>160.9</b>	269	82.1	<b>269.4</b>	<b>269.3</b>	<b>269.2</b>
56	17.1	<b>56.2</b>	<b>56.1</b>	<b>55.9</b>	164	50.1	<b>164.4</b>	<b>164.3</b>	<b>164.2</b>	273	83.1	<b>272.7</b>	<b>272.6</b>	<b>272.5</b>
(5 ft) 59	18.1	<b>59.5</b>	<b>59.3</b>	<b>59.2</b>	(14 ft) 168	51.1	<b>167.7</b>	<b>167.6</b>	<b>167.5</b>	(23 ft) 276	84.1	<b>276</b>	<b>275.9</b>	<b>275.7</b>
63	19.1	<b>62.7</b>	<b>62.6</b>	<b>62.5</b>	171	52.1	<b>171</b>	<b>170.9</b>	<b>170.8</b>	279	85.1	<b>279.3</b>	<b>279.1</b>	<b>279</b>
66	20.1	<b>66</b>	<b>65.9</b>	<b>65.8</b>	174	53.1	<b>174.3</b>	<b>174.2</b>	<b>174</b>	282	86.1	<b>282.5</b>	<b>282.4</b>	<b>282.3</b>
69	21.1	<b>69.3</b>	<b>69.2</b>	<b>69.1</b>	178	54.1	<b>177.6</b>	<b>177.4</b>	<b>177.3</b>	286	87.1	<b>285.8</b>	<b>285.7</b>	<b>285.6</b>
(6 ft) 73	22.1	<b>72.6</b>	<b>72.5</b>	<b>72.3</b>	(15 ft) 181	55.1	<b>180.8</b>	<b>180.7</b>	<b>180.6</b>	(24 ft) 289	88.1	<b>289.1</b>	<b>289</b>	<b>288.9</b>
76	23.1	<b>75.9</b>	<b>75.7</b>	<b>75.6</b>	184	56.1	<b>184.1</b>	<b>184</b>	<b>183.9</b>	292	89.1	<b>292.4</b>	<b>292.3</b>	<b>292.1</b>
79	24.1	<b>79.1</b>	<b>79</b>	<b>78.9</b>	187	57.1	<b>187.4</b>	<b>187.3</b>	<b>187.2</b>	296	90.1	<b>295.7</b>	<b>295.5</b>	<b>295.4</b>
(7 ft) 82	25.1	<b>82.4</b>	<b>82.3</b>	<b>82.2</b>	(16 ft) 191	58.1	<b>190.7</b>	<b>190.6</b>	<b>190.4</b>	(25 ft) 299	91.1	<b>298.9</b>	<b>298.8</b>	<b>298.7</b>
86	26.1	<b>85.7</b>	<b>85.6</b>	<b>85.5</b>	194	59.1	<b>194</b>	<b>193.8</b>	<b>193.7</b>					
89	27.1	<b>89</b>	<b>88.9</b>	<b>88.7</b>	197	60.1	<b>197.2</b>	<b>197.1</b>	<b>197</b>					
92	28.1	<b>92.3</b>	<b>92.1</b>	<b>92</b>	200	61.1	<b>200.5</b>	<b>200.4</b>	<b>200.3</b>					
(8 ft) 96	29.1	<b>95.5</b>	<b>95.4</b>	<b>95.3</b>	(17 ft) 204	62.1	<b>203.8</b>	<b>203.7</b>	<b>203.6</b>					
99	30.1	<b>98.8</b>	<b>98.7</b>	<b>98.6</b>	207	63.1	<b>207.1</b>	<b>207</b>	<b>206.8</b>					
102	31.1	<b>102.1</b>	<b>102</b>	<b>101.9</b>	210	64.1	<b>210.4</b>	<b>210.2</b>	<b>210.1</b>					
105	32.1	<b>105.4</b>	<b>105.3</b>	<b>105.1</b>	214	65.1	<b>213.6</b>	<b>213.5</b>	<b>213.4</b>					
(9 ft) 109	33.1	<b>108.7</b>	<b>108.5</b>	<b>108.4</b>	(18 ft) 217	66.1	<b>216.9</b>	<b>216.8</b>	<b>216.7</b>					

Injection Molded End Cap (IEC)

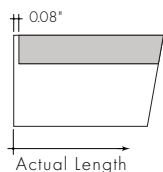

Injection Molded End Power Feed (IEPF)

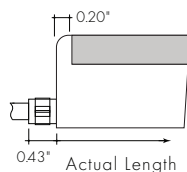

Injection Molded Bottom Power Feed (IBPF)

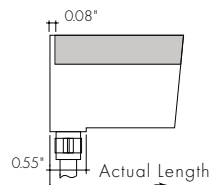

Injection Molded Side Power Feed (ISPF)

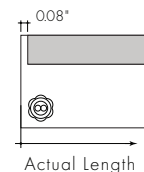

## Power Supplies

See Power Supply instructions and spec sheet for wiring information. For a complete list of compatible dimmers, see Compatible Dimming Chart on the Resources page.

### Universal Power Supply 1% 120VAC - 277VAC

MODEL	POWER	OUTPUT
PDCU-D - IP20 Dry Series	30 - 30 W 60 - 60 W 96 - 96 W 3X96 - 3X96 W	24 - 24 VDC
PDCU-W - IP66 Wet Series	96 - 96 W 3X96 - 3X96 W	

0-10V dims down to 1%, MLV/ELV/TRIAC dims down to 1%.  
For a complete list of compatible dimmers, see [Compatible Dimming Chart](#) on the Resources page.

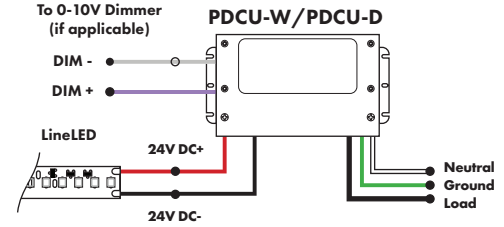

MODELS	PDCU-W 96W	PDCU-W 3X96W	PDCU-D 30W	PDCU-D 60W	PDCU-D 96W	PDCU-D 3X96W
<b>Length</b>	8.66"	11.85"	6.10"	7.93"	8.25"	9.57"
<b>Width</b>	3.73"	4.32"	3.35"	3.35"	4.10"	5.94"
<b>Depth</b>	1.61"	1.81"	1.33"	1.32"	1.56"	1.13"

### 0-10V Dimming Power Supplies 0.1% 120VAC - 277VAC

MODEL	POWER	OUTPUT	DIMMING
PS010V - 0-10V Power Supply dims down to 0.1%	96 - 96 Watt 3X96 - 3 X 96 Watt	24 - 24 VDC	LIN - Linear LOG - Logarithmic

MODELS	96W	3X96
<b>Length</b>	14.40"	15.75"
<b>Width</b>	5.20"	6.62"
<b>Depth</b>	2.60"	4.95"

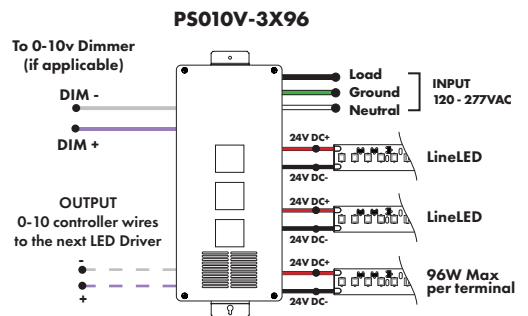
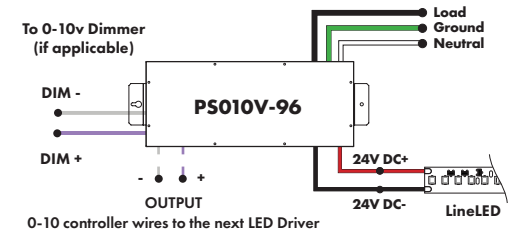

### Triac, MLV, & ELV Compatible Dimmers

MODEL	POWER	OUTPUT
PDC - (IP20) Power Supply	96 - 96 Watts	24 - 24 VDC

MODELS	96W
<b>Length</b>	8.25"
<b>Width</b>	4.10"
<b>Depth</b>	1.56"

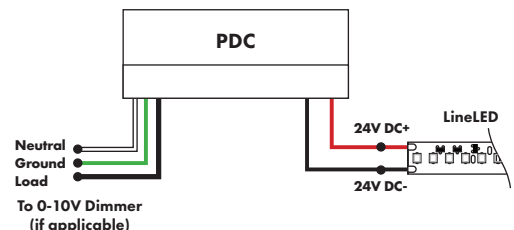

**Power Supplies**

See Power Supply instructions and spec sheet for wiring information. For a complete list of compatible dimmers, see Compatible Dimming Chart on the Resources page.

**DMX Dimming Power Supplies 120VAC - 277VAC**

MODEL	POWER	OUTPUT
PSDMX - DMX Power Supply dims down to 0%	96 - 96 Watt 3X96 - 3 X 96 Watt	24 - 24 VDC

Features eldoLED's LINEARdrive configurable dimmable drivers

MODELS	96W	3X96
<b>Length</b>	14.40"	15.75"
<b>Width</b>	5.20"	6.62"
<b>Depth</b>	2.60"	4.95"

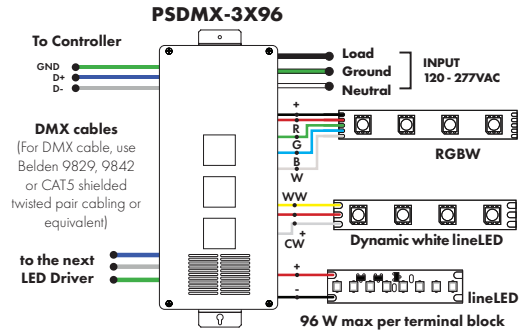
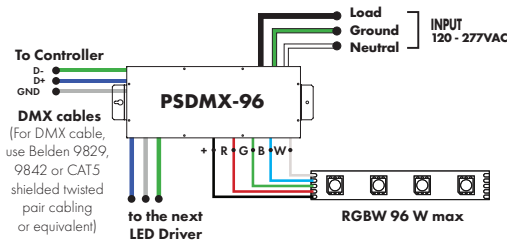

**DALI 0% Dimming Power Supplies 120VAC - 277VAC**

MODEL	POWER	OUTPUT
PSDALI - DALI Power Supply dims down to 0%	96 - 96 Watt 3X96 - 3 X 96 Watt	24 - 24 VDC

Features eldoLED's LINEARdrive configurable dimmable drivers

Model	96W	3X96
<b>Length</b>	14.40"	15.75"
<b>Width</b>	5.20"	6.62"
<b>Depth</b>	2.60"	4.95"

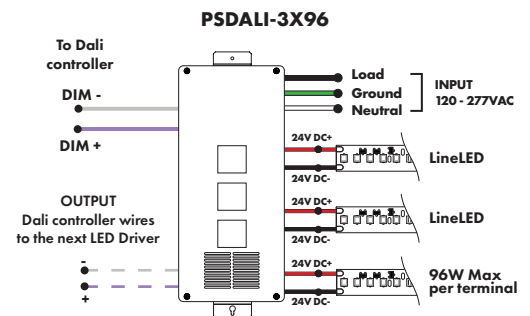
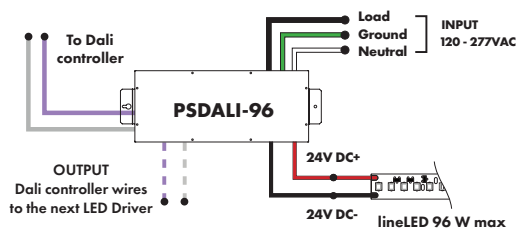

**Enlighted Enabled Dimming Power Supplies 120VAC - 277VAC**

MODEL	POWER	OUTPUT	DIMMING	LOCATION
PSV - PSV Series	96 - 96 Watt	24 - 24 VDC	ENL - Enlighted Dimming dims down to 0%	D - Damp

Model	96W
<b>Length</b>	14.40"
<b>Width</b>	5.20"
<b>Depth</b>	2.60"

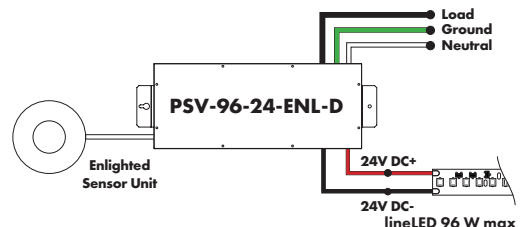

## Power Supplies

See Power Supply instructions and spec sheet for wiring information. For a complete list of compatible dimmers, see Compatible Dimming Chart on the Resources page.

### Non-Dimming Power Supply 120VAC - 277VAC

MODEL	POWER	OUTPUT	DIMMING	LOCATION
PSV - PSV Series	96 - 96 Watt	24 - 24 VDC	ND - Non Dimming	D - Damp

MODELS	96W
<b>Length</b>	14.40"
<b>Width</b>	5.20"
<b>Depth</b>	2.60"

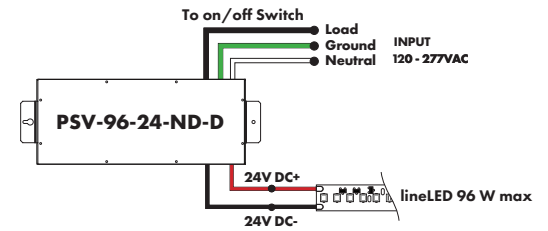

Luminii is a Lutron OEM Advantage Partner

### Lutron Power Supplies 1%

MODEL
<b>L3DA4U1UKL-CV240</b>

HiLume™ 1% EcoSystem Voltage LED driver  
40W max

MODELS	L3DA4U1UKL-CV240
<b>Length</b>	4.98"
<b>Width</b>	4.00"
<b>Depth</b>	2.62"

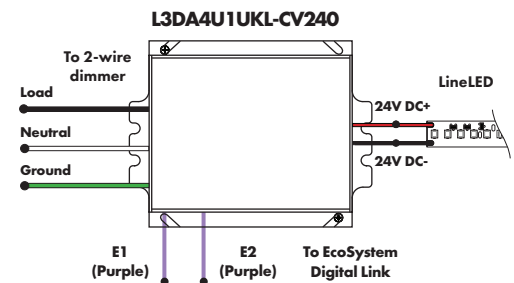

Luminii is a Lutron OEM Advantage Partner

### Lutron Power Supplies 0.1%

MODEL
<b>L3D0-96W24V-U</b>

HiLume™ 0.1% EcoSystem Voltage LED Driver with Soft-On, Fade-to-Black™  
96W max

MODELS	L3D0
<b>Length</b>	10.50"
<b>Width</b>	5.50"
<b>Depth</b>	2.00"

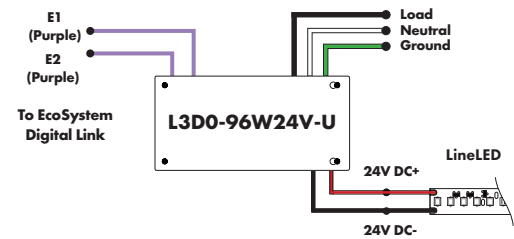

### In-Ground Power Supplies

MODEL	POWER	OUTPUT	INPUT
IG - In ground CVE Series	CVE - ELV Dimming DALI - eldoLED Dali dimming Both dims down to 0%	96X2 - 2 X 96 Watt	Blank - 120 V 277 - 240/277 V

MODELS	Dual Circuit
<b>Length</b>	8.40"
<b>Width</b>	8.30"
<b>Depth</b>	8.10"

