



Features

- Pendant Mount supports Stenos directional and ambient modules
- Minimalist and narrow track seamlessly integrates into environments
- Two channel track allows independent dim control for groups of modules when paired with appropriate power supplies
- 24 VDC Class 2 power supply
- Custom drawing and approval is required for every STENOS Track System prior to order acceptance.
- Snap-in Electrical Joiners include magnetic black/white Cover Plates to maintain clean aesthetic.
- 4A max on track
- 96W max on track
- Dry location only

Finish Options

- Black powder coated
- White powder coated



Product Dimensions

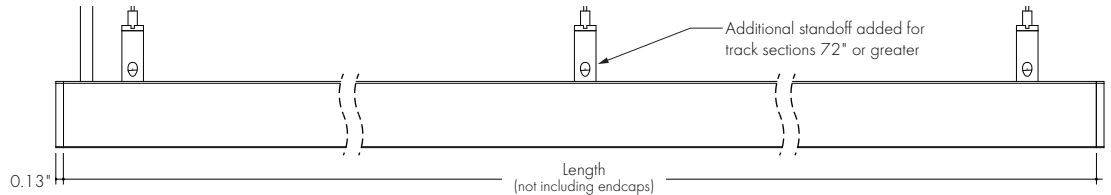
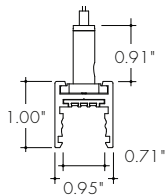

Straight Run

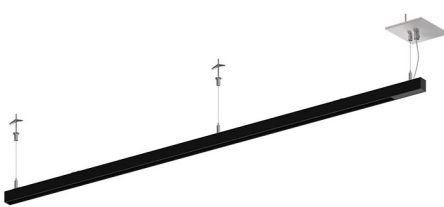

L Shape

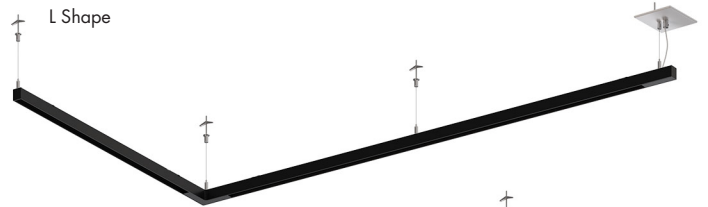

U Shape

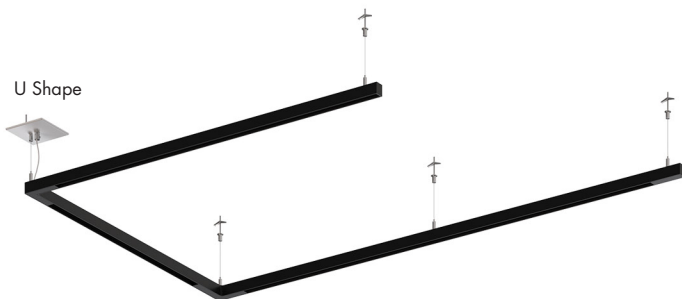

Rectangle Shape

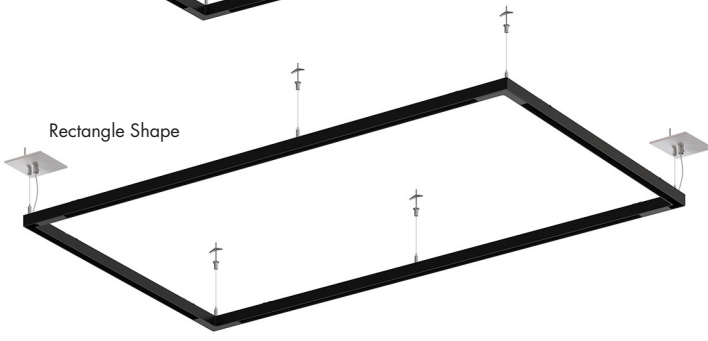

Ordering Code

example: STHR-40-BK-2CHDMX-240-CXXXXXX

MODEL ¹	SHAPE	OVERALL LENGTH	FINISH ²	POWER SUPPLY ³	WATTAGE	SERIAL NUMBER
STH-Stenos Suspended Track	S-Straight Run R-Rectangle Shape L-L Shape U-U Shape	-Overall run length of system/shape in feet [rounded up to the nearest foot] ⁴	BK-Black WH-White	2CHDMX-2 Channel DMX, 0.1%, PSDMX DWDT8-Dynamic White, DALI DT8, 0.1%, PSDALI-DT8 DWO10V-Dynamic White 0-10V, 0.1%, PSO10VD-W2C WDO10V-Warm Dim Curve (with Dynamic White Module), 0-10V, 0.1%, PSO10VD-WW DWDT8-AWNR-Dynamic White, DALI DT8 with Lutron Athena, 0.1%, PSDALI-DT8-AWNR WDO10V-AWNR-Warm Dim Curve (with Dynamic White Module), 0-10V with Lutron Athena, 0.1%, PSO10VD-WW-AWNR	-Watts (rounded up to the nearest Watt, see Wattage Calculation Guide, next page)	Serial Number, entered by Luminii

1 - Custom drawing and approval is required for every STENOS Track System prior to order acceptance. Allow 2 weeks (typical) for custom drawing generation/confirmation process. Use STENOS Track System Sketch Grid to convey as many details as possible including: shape, dimension of each leg, desired location of power feeds, and location of track modules (Directional, Ambient, Track Heads).
 2 - Suspended Power Feed Canopies and Cord match fixture Finish as standard, please include note for alternate Canopy/Fixture finish combination
 3 - Power supplies are 120-277 VAC input, unless otherwise noted.
 4 - Mechanical joiners are required for legs longer than 12ft

Product Dimensions

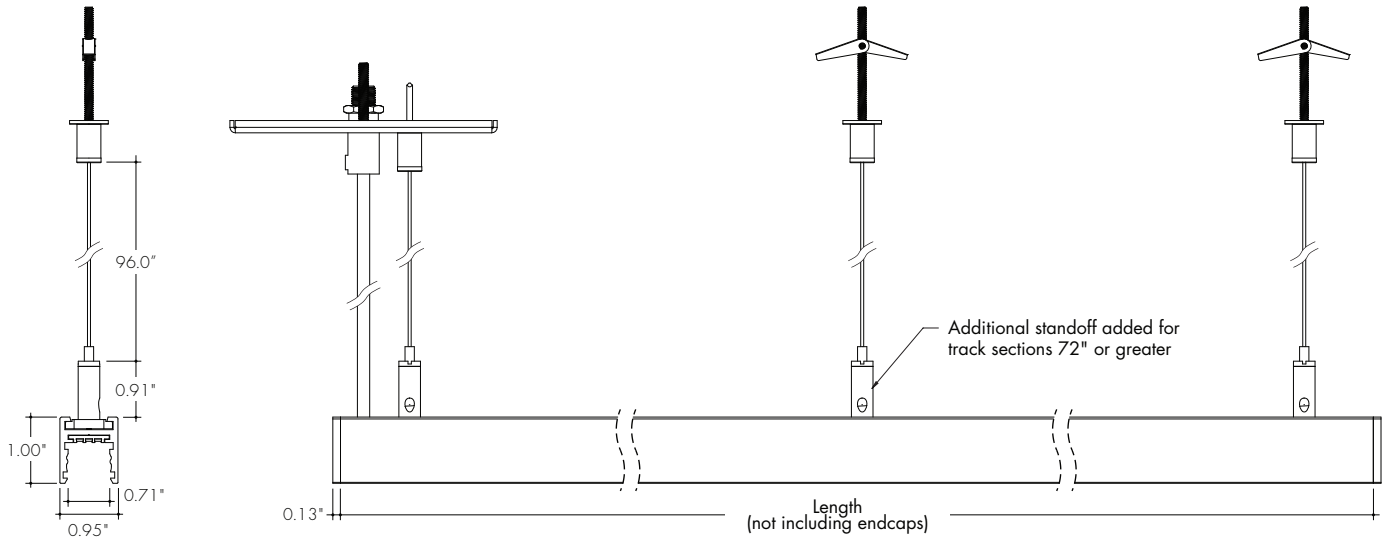

Stenos Track with Directional Module and with lower

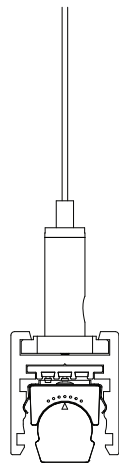

Stenos Track with Ambient Module

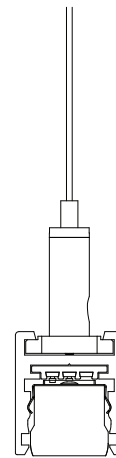
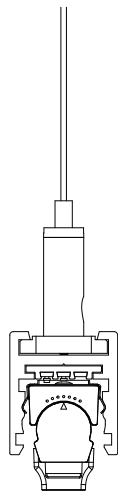

Wattage Calculation Guide

Stenos Track Module	Wattage	Lumens (3000K)	Length	Reference
STENOS 3" Directional Module	2.6 W	250 lm	2.5 in	
STENOS 5" Directional Module & STENOS 5" Wall Wash Module	5.4 W	520 lm 275 lm	4.8 in	
STENOS 12" Directional Module & STENOS 12" Wall Wash Module	13.0 W	1260 lm 665 lm	11.8 in	
STENOS 1" Track Head Long 15° optic Regressed Baffle	6.6 W	565 lm	4.9 in	
STENOS 1" Track Head Short 15° optic Regressed Baffle	5.2 W	458 lm		
STENOS 24" Ambient Module SO	5.5 W	475 lm	24.4 in	
STENOS 24" Ambient Module HO	12.3 W	1000lm	24.4 in	
STENOS 48" Ambient Module SO	11.0 W	950 lm	48.0 in	
STENOS 48" Ambient Module HO	24.7 W	2025 lm	48.0 in	

Wattage Calculation Guide (Example)

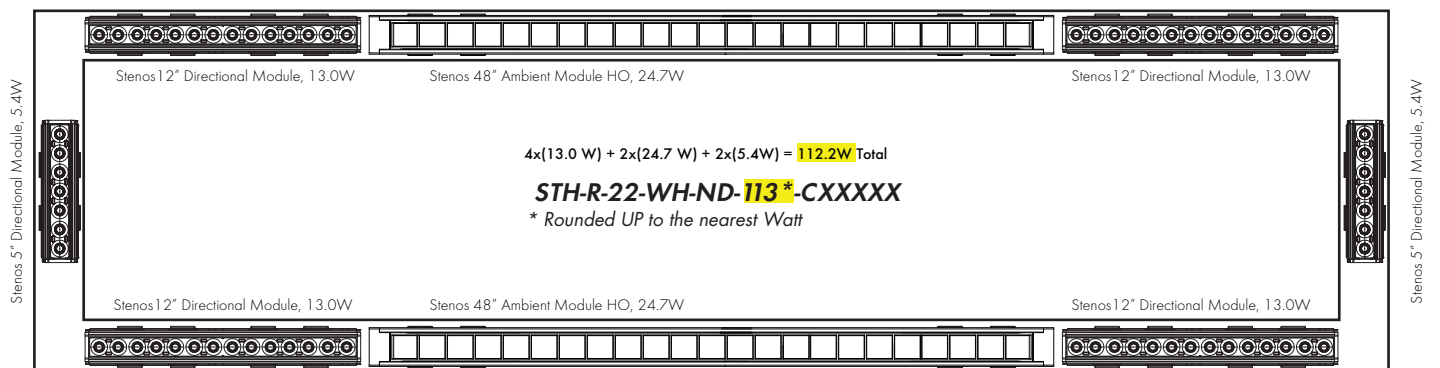

Factory Built Sections

Straight Run

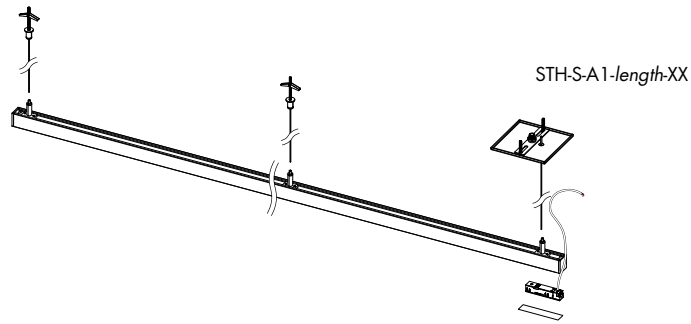

L Shape

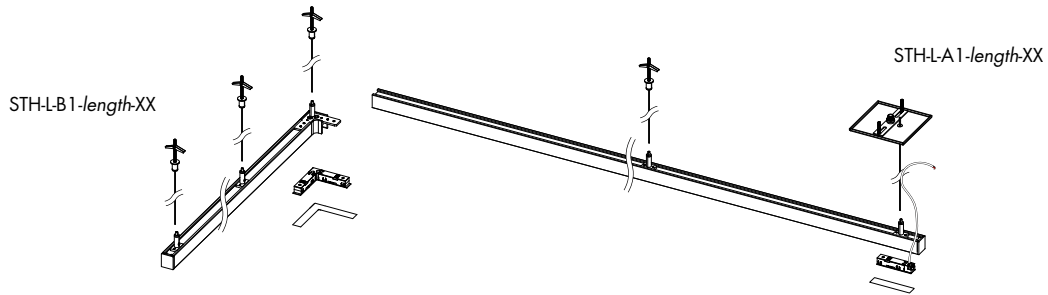

U Shape

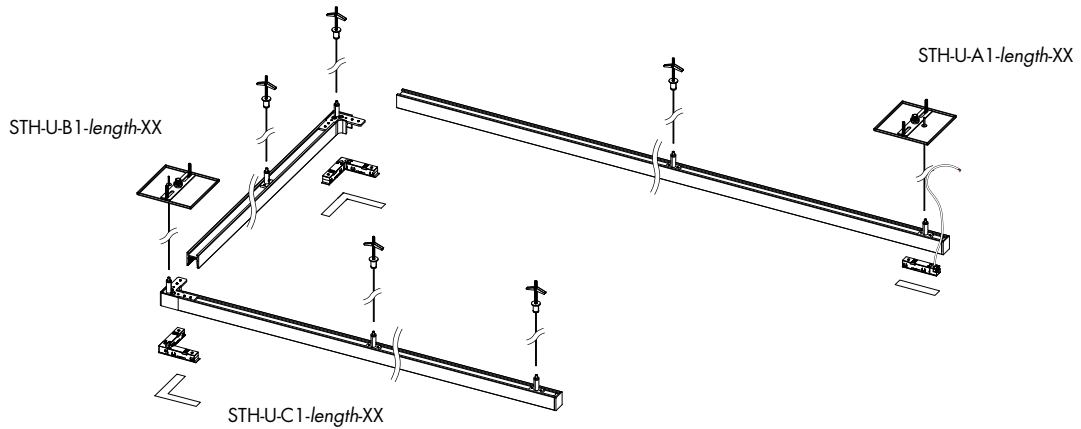

Rectangle Shape

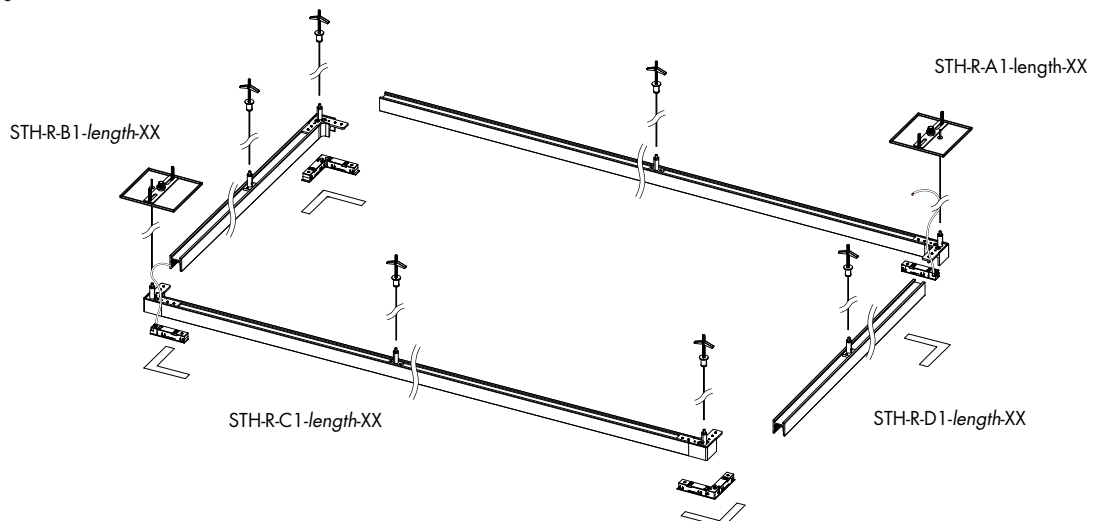

Power Supplies

See Power Supply instructions and spec sheet for wiring information. For a complete list of compatible dimmers, see Compatible Dimming Chart on the Resources page.

Dynamic White Control

-2CHDMX

2 CHANNEL DMX, 0.0%, 120-277VAC, PSDMX

MODELS	96W
Length	14.40"
Width	5.20"
Depth	2.60"

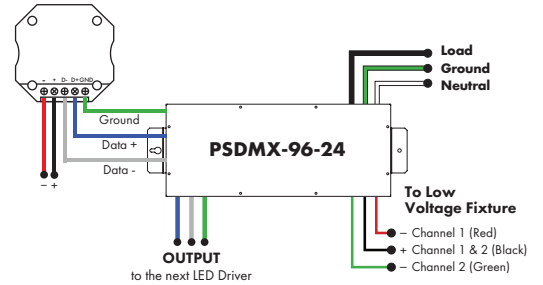

-DWDT8

DYNAMIC WHITE, DALI DT8, 0.1%, PSDALI-DT8

MODELS	96W
Length	14.40"
Width	5.20"
Depth	2.60"

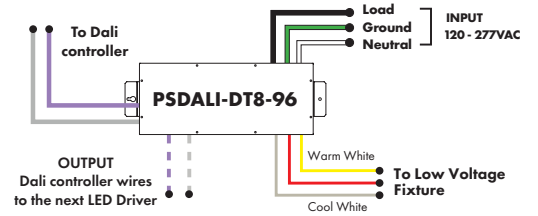

-DW010V

DYNAMIC WHITE 0-10V, 0.1%, PSV010-W2C, PS010VD-W2C

MODELS	96W
Length	14.40"
Width	5.20"
Depth	2.60"

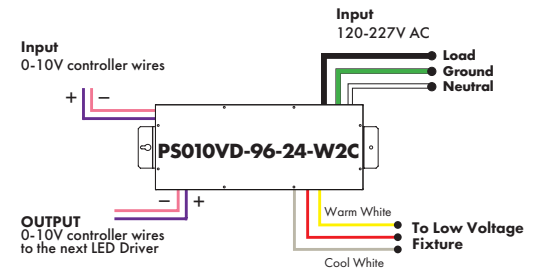

Warm Dim Control (With Dynamic White Module)

-WD010V

WARM DIM CURVE (WITH DYNAMIC WHITE MODULE), 0-10V, 0.1%, PS010VD-WW

MODELS	96W
Length	14.40"
Width	5.20"
Depth	2.60"

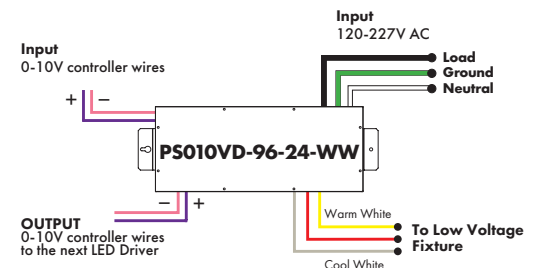
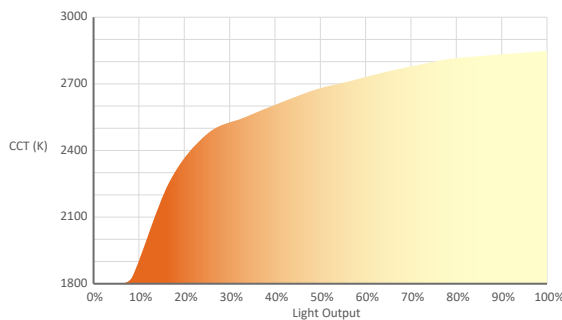

Track Components (for field configurable systems)

To minimize voltage drop, it is recommended to not exceed 24ft of track per power feed or 3 track joiners per power feed.

EC-ST5-H3-SF-XX
Suspended End Caps

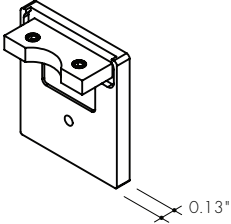

Blank End Cap for ending a Suspended run

ST-JOIN-M-STH-AC
Suspended Mechanical Joiner Bracket

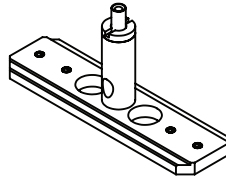

Used for mechanically joining adjacent Track sections

MB-STH-AC-G
Suspended Track Cable Gripper

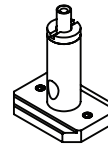

Used for suspending Track sections. Track sections longer than 72" require a middle suspension point.

JOIN-M-L-STH-AC-XX
Suspended Mechanical L Joiner

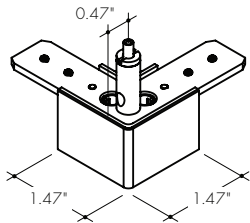

For creating a 90° in-plane corner

TC-96-XX
Track Cover, 96"

TC-144-XX
Track Cover, 144"

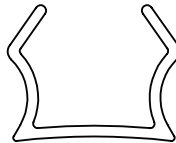

Track Covers ship complete with Suspended Track and cover unoccupied sections of track. They are field cuttable. Additional can be ordered, if necessary.

XX	Color
WH	White
BK	Black

MB-STH-AC-JB4-SF-96-XX
Square Power Feed Canopy and 96" Aircraft Cable for Joiner Attachment

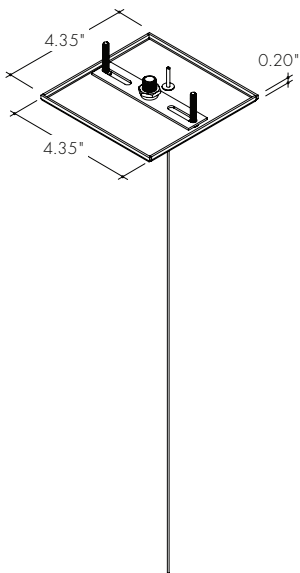

Aircraft Cable is Mounted to Canopy

MB-STH-AC-JB4-CF-96-XX
Square Power Feed Canopy

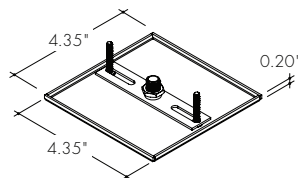

Blank canopy for power feed wire. Use if j-box is offset from fixture/mounting position.

MB-STH-AC-NF-96
96" Aircraft Cable and Ceiling Mount



Track Components

To minimize voltage drop, it is recommended to not exceed 24ft of track per power feed or 3 track joiners per power feed.

ST-JOIN-E-P

Electrical Power Feed, with black and white Cover Plates

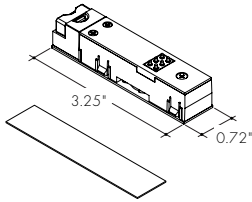

For use with 18AWG field wires with max outer diameter 0.300"
Only 1 Power Feed allowed per electrically connected sections of track.

ST-JOIN-E-P-108-XX

Electrical Power Feed, 108" Black/White Jacket Cable

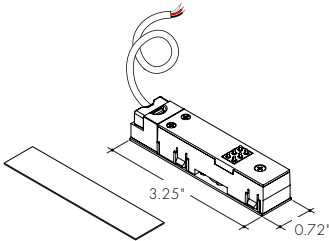

with Black and White cover plates
Only 1 Power Feed allowed per electrically connected sections of track.

ST-JOIN-E-L

Electrical Joiner, L with black and white Cover Plates

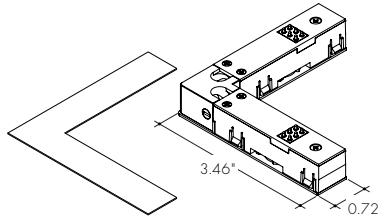

For for use with Mechanical L Joiner

ST-JOIN-E-S

Electrical Joiner, Straight, with black and white Cover Plates

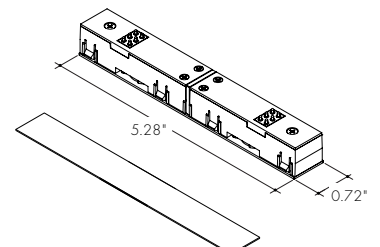

For electrically joining adjacent Track sections

STH-48/96/144-SP-XX

Stenos Suspended Track

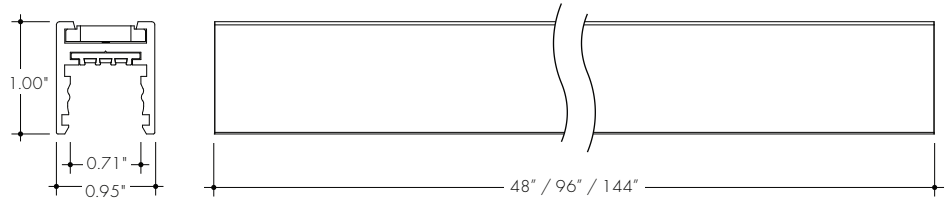

XX	Color
WH	White
BK	Black

Wiring and Multiple Channels

For **single channel** use, connect black and white power feed wires.
For **two channel** use, connect per wiring diagram in the Two Channel Control section of power supplies
For **Dynamic White** use, connect per wiring diagram in the Dynamic White section of power supplies

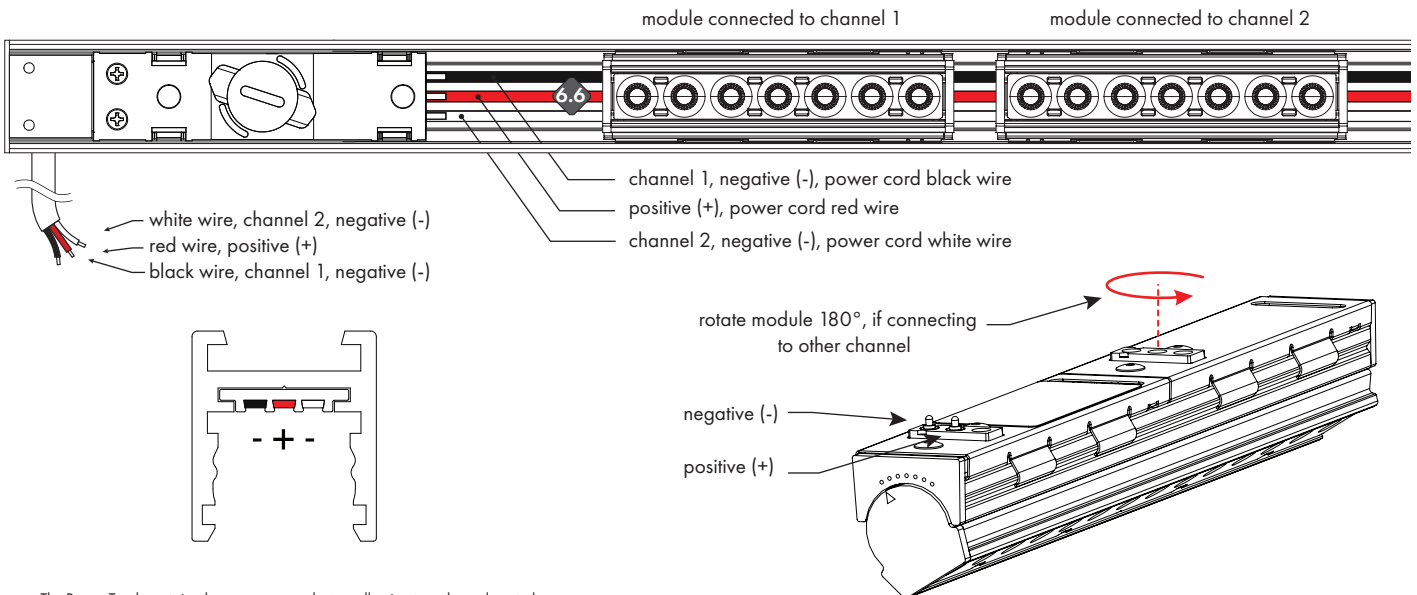

The Power Track contains three copper conductors allowing two channel control .

- Center conductor is common positive (+), connected to power cord red wire
- One outer conductor is channel 1 negative (-), connected to power cord black wire
- Other outer conductor is channel 2 negative (-), connected to power cord white wire

Select control channel for Stenos Directional and Ambient Modules by rotating them 180°
For two channels use, connect per wiring diagram in the Two Channel Control section of power supplies
For single channel use, connect black and white power feed wires.

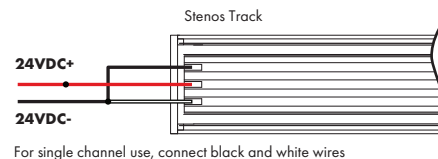

STENOS Track System Sketch Grid

Use grid below to sketch out details of the STENOS Track System. Include as many details as possible such as:

- Shape
- Dimensions of each leg
- Location of Power Feeds
- Location and Type of Track Modules (Directional, Ambient, Track Heads)

Note: 96W max, 24ft max,
and 3 electrical joiners max
per power feed
See example on next page

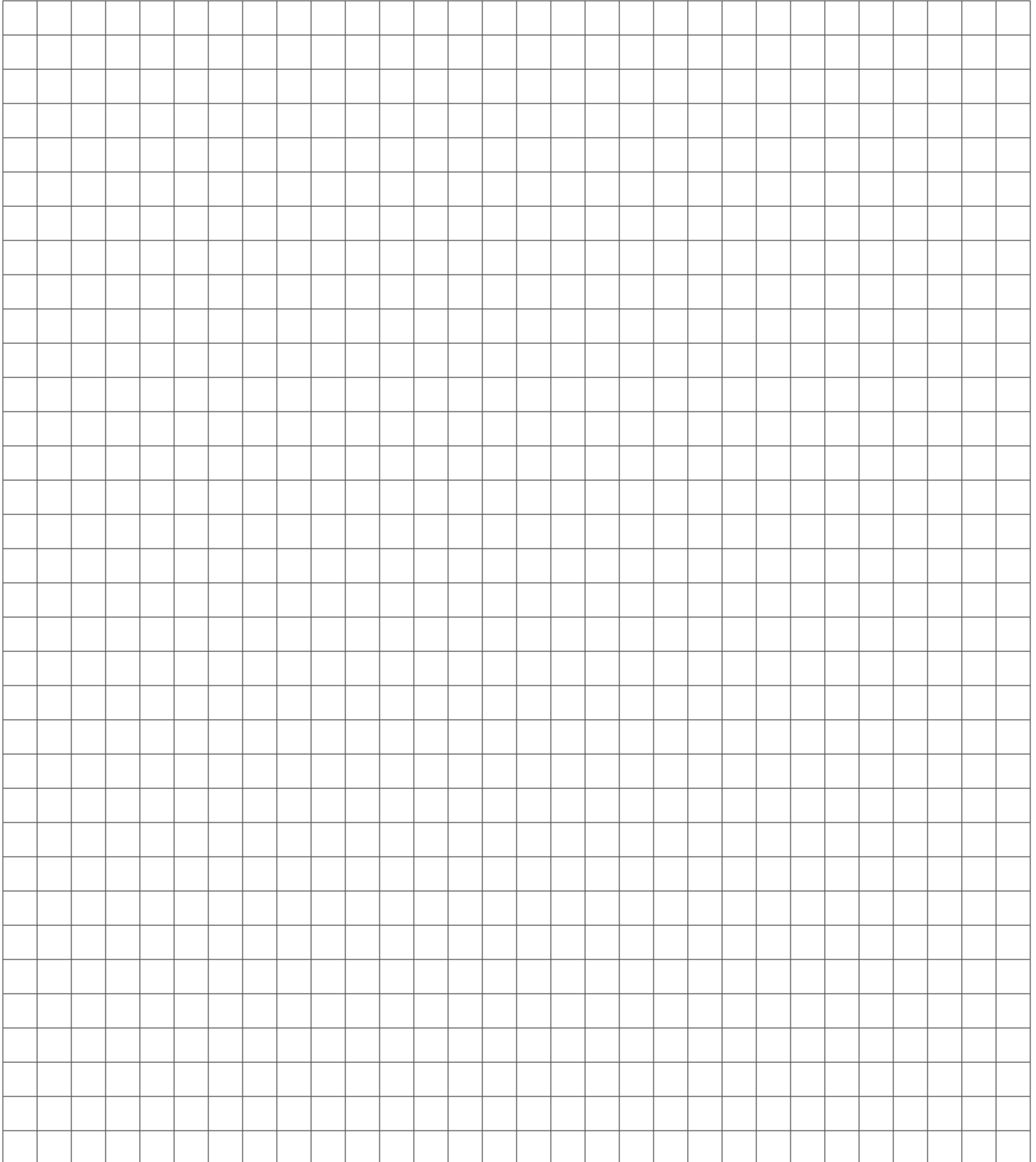

STENOS Track System Sketch Grid (Example)

Use grid below to sketch out details of the STENOS Track System. Include as many details as possible such as:

- Shape
- Dimensions of each leg
- Location of Power Feeds
- Location and Type of Track Modules (Directional, Ambient, Track Heads)

Note: 96W max, 24ft max, and 3 electrical joiners max per power feed

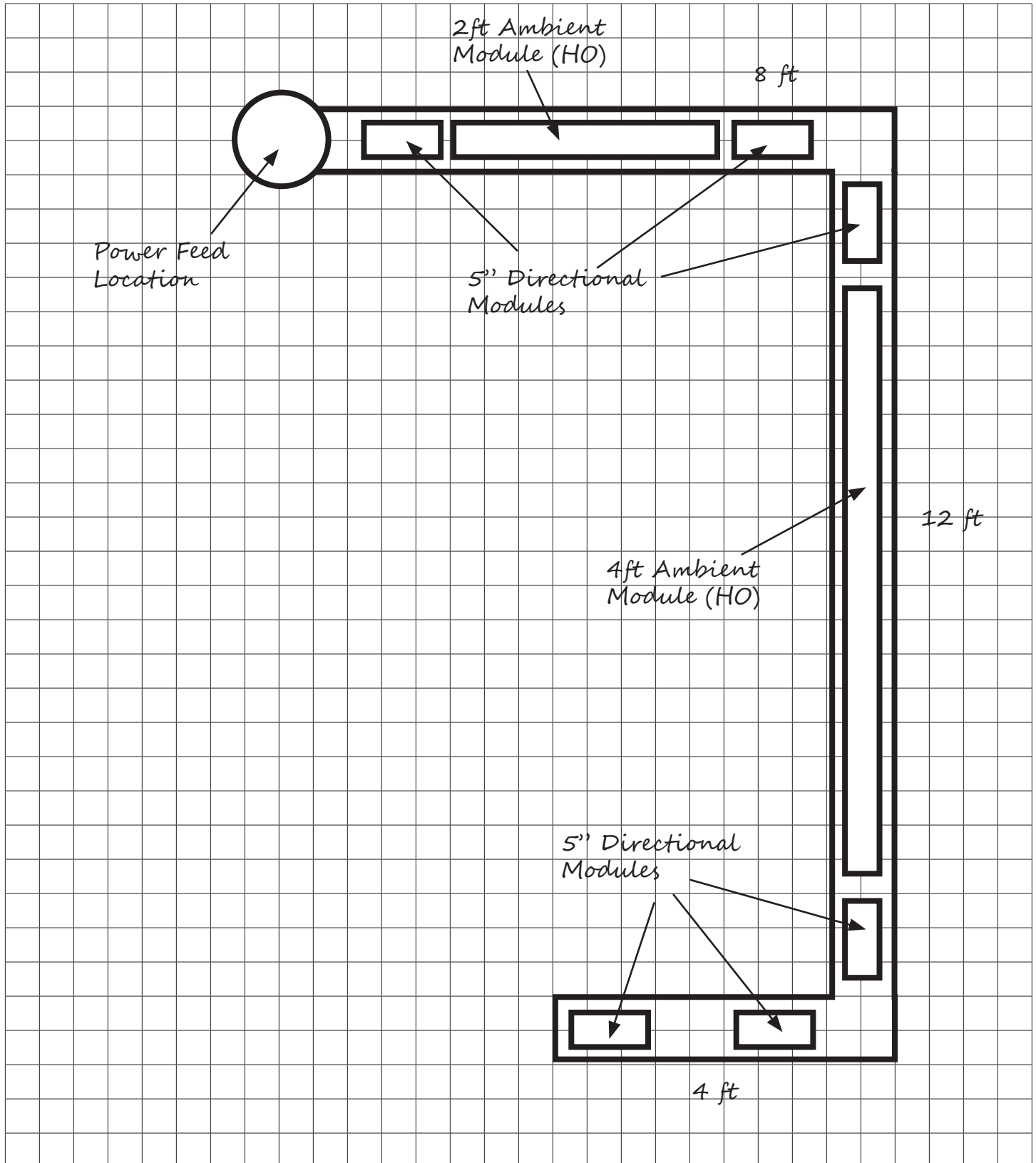

Additional Stenos Products



(left to right)
Stenos Recessed Deep Trimless Track
Stenos Recessed Trimless Track
Stenos Recessed Trimmed Track
Stenos Surface Mount Track
Stenos Suspended Track



Stenos Directional Module

Stenos Directional Module with Louver

Stenos Directional Module with Wall Wash

Stenos Ambient Module

Stenos Ambient Module with Louver

