



FLEX STP 70 is a high performance flexible LED fixture distinguished by its extremely tight LED pitch and ability to blend in shallow channels, making it perfect for direct view applications.

ELECTRICAL

Input Voltage	24VDC
Dimming Options	<ul style="list-style-type: none"> • PURE DC™ • MLV • 0-10V • DMX • Lutron (2-WIRE, 3-WIRE, EcoSystem)
Power Consumption	7.0 Watts per foot
Wire Size	20AWG, 2 wire
Certification	ETL - Conforms to UL Std. 2108; Certified to CSA Std. C22.2 No. 9.0 Title 24 - Selected models are JA8 2016 compliant when used with 0-10V, DMX, or Lutron Premier dimming.

PHYSICAL

Field Cuttable	Every 0.90" (22.86mm)
Operating Temperature	-20° C (-40°F) to +50°C (+122°F)
Environment	IP20 - Dry Location
Maximum Run Length	13.00'
Dimensions (WxH)	0.39" (10.00mm) x 0.07" (1.78mm)

ACCESSORIES

Channels¹	Optic Arts® Channel (pg. 3-6)
Connectors	LC-I2P-M, LC-I2P-F (pg. 7)
Strain Relief	FLEX.ZIP (pg. 7)
FLEXConfig-1 Accessories	FLEXSTP.PFC.02.08, FLEXSTP.BSC.02.08, LO-18G-2C-W-72, LP-18G-2C-W-72, LO-18G-2C-W-SP, LP-18G-2C-W-SP (pg. 8)

¹: Must be used in conjunction with Optic Arts® Channel for proper heat dissipation.

LUMEN OUTPUT

1800K	350.00 lm/ft 50.00 lm/W
2350K	490.00 lm/ft 70.00 lm/W
2750K JA8 2016²	538.00 lm/ft 77.00 lm/W
2930K JA8 2016²	567.00 lm/ft 81.00 lm/W
3550K JA8 2016²	595.00 lm/ft 85.00 lm/W
4000K JA8 2016²	595.00 lm/ft 85.00 lm/W

Note: Stated lumen values have a tolerance of +/- 10%.

²: JA8 2016 when used with 0-10V, DMX, or Lutron Premier dimming.

PERFORMANCE

CRI	2350-4000K = 95+, 1800K = 90+
TM-30	See pages 16-20
Lumen Maintenance	When used in Optic Arts® CHS-S-1208 or larger channel: 50,000 Hours L70
Binning Tolerance	+/- 100K
Warranty	5 years

PART NUMBER BUILDER

SERIES	+	IP RATING	+	COLOR	+	VOLTAGE	+	WATTAGE	+	CONFIGURATION	+	LENGTH
FLEXSTP		20 = IP20 - Dry Location		18 = 1800K 23 = 2350K 27 = 2750K ² 29 = 2930K ² 35 = 3550K ² 40 = 4000K ²		24 = 24 VDC		70 = 7.0W		FLC1 = FLEX Config 1 FLC2 = FLEX Config 2 FLC3 = FLEX Config 3		XX = Custom Length

²: JA8 2016 when used with 0-10V, DMX, or Lutron Premier dimming.

DIMENSIONS

Optic Arts® cuts all FLEX and Channel products to length per customer specifications. Each length of FLEX is fitted with a 6' wire lead (custom lengths available upon request) and packaged on a reel in an anti-static bag. Bags are labeled with fixture type, length and location (if applicable). Each piece of channel is labeled with fixture type, length and location (if applicable), and is bundled by fixture type.

- Due to the nature of the FLEX product, specific lengths may not fall exactly on a cutting point. In this case, Optic Arts® will always cut to the smaller dimension unless otherwise specified.
- Unless otherwise specified, channel is cut 15mm longer than FLEX.
- Some on-site assembly required. See installation guides for details.

INDOOR FLEX STP 70

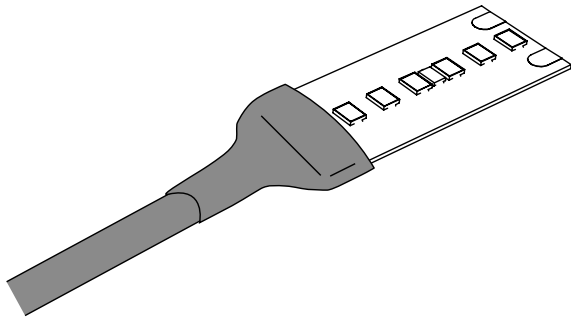
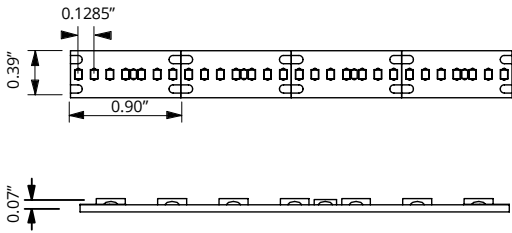

INDOOR DIMENSIONS

Width	0.39" (10.00mm)
Height	0.07" (1.78mm)
Cutttable Segment Length	0.90" (22.86mm)
Pitch Length	0.1285" (3.26mm)
Max Run Length	13.00' (3962.40mm)

INDOOR FLEX STP 70

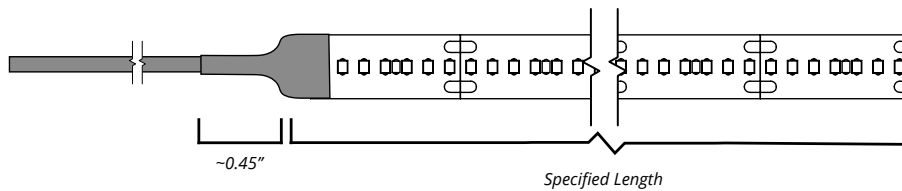

KEY

CHANNEL PART NUMBER BREAKDOWN:

CHS	+	R	+	1208
SERIES		APPLICATION		DIMENSIONS
CHS = Slim Channel CHW = Wide Channel		S = Surface Mount R = Recessed Mount C = Corner Mount H = Hanging Mount		XXXX = W x H (mm)

CHS-R-1208

• Click on channel titles below to access complete channel cut sheets

DIFFUSION LEVEL:

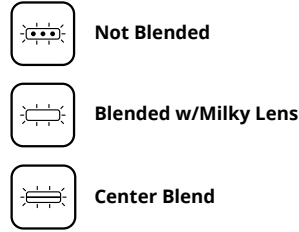

CONFIGURATION:

- 1** Configuration 1
- 1a** Configuration 1 with Auxiliary Housing Accessory
See page 7 for Flex Connect Auxiliary Housing Accessories
- 2** Configuration 2
- 3** Configuration 3

CHS-R-1208

Fits IP40 FLEX STP only

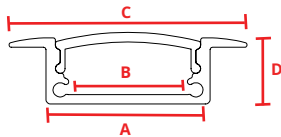

- A:** 0.68" (17.25mm)
- B:** 0.50" (12.59mm)
- C:** 0.98" (25.00mm)
- D:** 0.34" (8.60mm)



2

MATERIAL	Anodized Aluminum						
DESCRIPTION	Slim and shallow recessed channel.						
LENGTH	2 meter						
LENS TYPES	<table border="0"> <tr><td>Clear</td><td>CHS-12mm-CC</td></tr> <tr><td>Frosted</td><td>CHS-12mm-CF</td></tr> <tr><td>Milky</td><td>CHS-12mm-CM</td></tr> </table>	Clear	CHS-12mm-CC	Frosted	CHS-12mm-CF	Milky	CHS-12mm-CM
Clear	CHS-12mm-CC						
Frosted	CHS-12mm-CF						
Milky	CHS-12mm-CM						
ACCESSORIES	<table border="0"> <tr><td>Endcap</td><td>CHS-R-1208-EC</td></tr> <tr><td>Endcap w/hole</td><td>CHS-R-1208-ECH</td></tr> </table>	Endcap	CHS-R-1208-EC	Endcap w/hole	CHS-R-1208-ECH		
Endcap	CHS-R-1208-EC						
Endcap w/hole	CHS-R-1208-ECH						

CHS-S-1208

Fits IP40 FLEX STP only

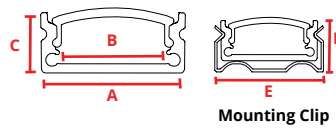

- A:** 0.68" (17.25mm)
- B:** 0.50" (12.59mm)
- C:** 0.34" (8.60mm)
- D:** 0.40" (12.70mm)
- E:** 0.78" (19.90mm)



1a

2

3

MATERIAL	Anodized Aluminum								
DESCRIPTION	Slim and shallow surface mounted channel.								
LENGTH	2 meter								
LENS TYPES	<table border="0"> <tr><td>Clear</td><td>CHS-12mm-CC</td></tr> <tr><td>Frosted</td><td>CHS-12mm-CF</td></tr> <tr><td>Milky</td><td>CHS-12mm-CM</td></tr> <tr><td>Grazer</td><td>CHS-12mm-CG</td></tr> </table>	Clear	CHS-12mm-CC	Frosted	CHS-12mm-CF	Milky	CHS-12mm-CM	Grazer	CHS-12mm-CG
Clear	CHS-12mm-CC								
Frosted	CHS-12mm-CF								
Milky	CHS-12mm-CM								
Grazer	CHS-12mm-CG								
ACCESSORIES	<table border="0"> <tr><td>Endcap</td><td>CHS-S-1208-EC</td></tr> <tr><td>Endcap w/hole</td><td>CHS-S-1208-ECH</td></tr> <tr><td>Mounting Clip</td><td>CHS-S-1208-MC</td></tr> <tr><td>Rotating Mounting Clip</td><td>CHS-S-1208-MCR</td></tr> </table>	Endcap	CHS-S-1208-EC	Endcap w/hole	CHS-S-1208-ECH	Mounting Clip	CHS-S-1208-MC	Rotating Mounting Clip	CHS-S-1208-MCR
Endcap	CHS-S-1208-EC								
Endcap w/hole	CHS-S-1208-ECH								
Mounting Clip	CHS-S-1208-MC								
Rotating Mounting Clip	CHS-S-1208-MCR								

CHS-C-1919

Fits IP40 FLEX STP only

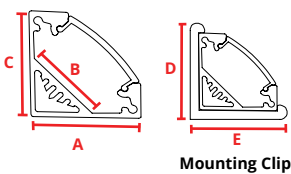

- A:** 0.73" (18.50mm)
- B:** 0.48" (12.20mm)
- C:** 0.73" (18.50mm)
- D:** 0.82" (20.82mm)
- E:** 0.82" (20.82mm)



1

2

3

MATERIAL	Anodized Aluminum						
DESCRIPTION	Slim corner mount channel.						
LENGTH	2 meter						
LENS TYPES	<table border="0"> <tr><td>Clear</td><td>CHS-12mm-CC</td></tr> <tr><td>Frosted</td><td>CHS-12mm-CF</td></tr> <tr><td>Milky</td><td>CHS-12mm-CM</td></tr> </table>	Clear	CHS-12mm-CC	Frosted	CHS-12mm-CF	Milky	CHS-12mm-CM
Clear	CHS-12mm-CC						
Frosted	CHS-12mm-CF						
Milky	CHS-12mm-CM						
ACCESSORIES	<table border="0"> <tr><td>Endcap</td><td>CHS-C-1919-EC</td></tr> <tr><td>Endcap w/hole</td><td>CHS-C-1919-ECH</td></tr> <tr><td>Mounting Clip</td><td>CHS-C-1919-MC</td></tr> </table>	Endcap	CHS-C-1919-EC	Endcap w/hole	CHS-C-1919-ECH	Mounting Clip	CHS-C-1919-MC
Endcap	CHS-C-1919-EC						
Endcap w/hole	CHS-C-1919-ECH						
Mounting Clip	CHS-C-1919-MC						

CHS-R-1715

Fits IP40 FLEX STP only

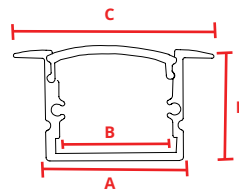

- A:** 0.68" (17.25mm)
- B:** 0.48" (12.30mm)
- C:** 0.98" (25.00mm)
- D:** 0.59" (15.05mm)



2

MATERIAL	Anodized Aluminum								
DESCRIPTION	Slim and deep recessed channel. Eliminates visible LED nodes when used with FLEXDC 3.0 and milk lens.								
LENGTH	2 meter								
LENS TYPES	<table border="0"> <tr><td>Clear</td><td>CHS-12mm-CC</td></tr> <tr><td>Frosted</td><td>CHS-12mm-CF</td></tr> <tr><td>Milky</td><td>CHS-12mm-CM</td></tr> <tr><td>Grazer</td><td>CHS-12mm-CG</td></tr> </table>	Clear	CHS-12mm-CC	Frosted	CHS-12mm-CF	Milky	CHS-12mm-CM	Grazer	CHS-12mm-CG
Clear	CHS-12mm-CC								
Frosted	CHS-12mm-CF								
Milky	CHS-12mm-CM								
Grazer	CHS-12mm-CG								
ACCESSORIES	<table border="0"> <tr><td>Endcap</td><td>CHS-R-1715-EC</td></tr> <tr><td>Endcap w/hole</td><td>CHS-R-1715-ECH</td></tr> </table>	Endcap	CHS-R-1715-EC	Endcap w/hole	CHS-R-1715-ECH				
Endcap	CHS-R-1715-EC								
Endcap w/hole	CHS-R-1715-ECH								

MOUNTING OPTIONS - COMPATIBLE CHANNELS

- Not Blended
 Blended w/Milky Lens
 1 Configuration 1
 1a Configuration 1 with Auxiliary Housing Accessory
 2 Configuration 2
 3 Configuration 3

CHS-S-1715

Fits IP40 FLEX STP only

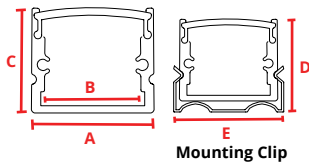

- A:** 0.68" (17.25mm)
B: 0.48" (12.30mm)
C: 0.59" (15.05mm)
D: 0.66" (16.76mm)
E: 0.78" (19.90mm)



MATERIAL
Anodized Aluminum



DESCRIPTION
Slim and deep surface mounted channel. Eliminates visible LED nodes when used with FLEXDC 3.0 and milky lens.



LENGTH
2 meter



LENS TYPES

Clear	CHS-12mm-CC
Frosted	CHS-12mm-CF
Milky	CHS-12mm-CM
Grazer	CHS-12mm-CG

ACCESSORIES

Endcap	CHS-S-1715-EC
Endcap w/hole	CHS-S-1715-ECH
Mounting Clip	CHS-S-1715-MC
Rotating Mounting Clip	CHS-S-1208-MCR

CHS-C-1616

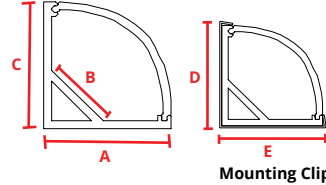

- A:** 0.63" (16.00mm)
B: 0.39" (10.00mm)
C: 0.63" (16.00mm)
D: 0.70" (17.78mm)
E: 0.70" (17.78mm)



MATERIAL
Anodized Aluminum



DESCRIPTION
Slim corner mount channel with rounded lens.



LENGTH
2 meter

LENS TYPES

Frosted	CHS-C-1616-CF
Milky	CHS-C-1616-CM

ACCESSORIES

Endcap	CHS-C-1616-EC
Endcap w/hole	CHS-C-1616-ECH
Mounting Clip	CHS-C-1616-MC

CHS-S-1922S

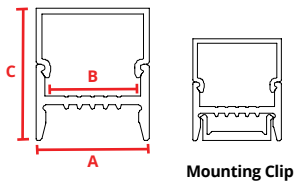

- A:** 0.77" (19.50mm)
B: 0.65" (16.50mm)
C: 0.86" (21.80mm)



MATERIAL
Anodized Aluminum



DESCRIPTION
Slim surface mounted channel with square wrap around lens. Mounting clip is fully concealed within fixture base.



LENGTH
2 meter



LENS TYPES

Milky	CHW-S-1922S-CM
-------	----------------

ACCESSORIES

Endcap	CHS-S-1922S-EC
Endcap w/hole	CHS-S-1922S-ECH
Mounting Clip	CHS-S-1922S-MC

CHS-S-1922R

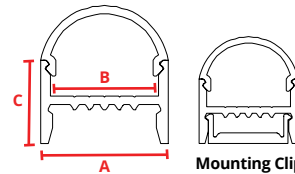

- A:** 0.77" (19.50mm)
B: 0.65" (16.50mm)
C: 0.86" (21.80mm)



MATERIAL
Anodized Aluminum



DESCRIPTION
Slim surface mounted channel with rounded wrap around lens. Mounting clip is fully concealed within fixture base.



LENGTH
2 meter



LENS TYPES

Milky	CHW-S-1922R-CM
-------	----------------

ACCESSORIES

Endcap	CHS-S-1922R-EC
Endcap w/hole	CHS-S-1922R-ECH
Mounting Clip	CHS-S-1922R-MC

CHW-S-2010

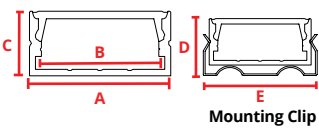

- A:** 0.93" (23.50mm)
B: 0.78" (20.00mm)
C: 0.39" (10.00mm)
D: 0.48" (12.19mm)
E: 1.02" (25.80mm)



MATERIAL
Anodized Aluminum



DESCRIPTION
Low profile surface mounted channel.



LENGTH
2 meter



LENS TYPES

Clear	CHW-S-2010-CC
Frosted	CHW-S-2010-CF
Milky	CHW-S-2010-CM

ACCESSORIES

Endcap	CHW-S-2010-EC
Endcap w/hole	CHW-S-2010-ECH
Mounting Clip	CHW-S-2010-MC
Rotating Mounting Clip	CHW-S-2010-MCR

CHW-R-2010

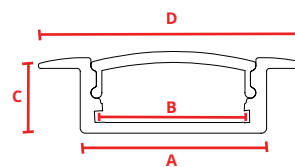

- A:** 0.93" (23.50mm)
B: 0.78" (20.00mm)
C: 0.39" (10.00mm)
D: 1.19" (30.24mm)



MATERIAL
Anodized Aluminum



DESCRIPTION
Recessed wide-profile channel.



LENGTH
2 meter

LENS TYPES

Clear	CHW-R-2010-CC
Frosted	CHW-R-2010-CF
Milky	CHW-R-2010-CM

ACCESSORIES

Endcap	CHW-R-2010-EC
Endcap w/hole	CHW-R-2010-ECH

MOUNTING OPTIONS - COMPATIBLE CHANNELS

- Not Blended
 Blended w/Milky Lens
 1 Configuration 1
 1a Configuration 1 with Auxiliary Housing Accessory
 2 Configuration 2
 3 Configuration 3

CHW-C-3030

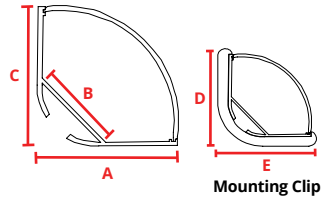

- A:** 1.18" (30.00mm)
B: 0.78" (20.20mm)
C: 1.18" (30.00mm)
D: 1.29" (32.77mm)
E: 1.29" (32.77mm)



MATERIAL

Anodized Aluminum



DESCRIPTION

45 degree channel with rounded lens.



LENGTH

2 meter



LENS TYPES

Clear	CHW-C-3030-CC
Frosted	CHW-C-3030-CF
Milky	CHW-C-3030-CM

ACCESSORIES

Endcap	CHW-C-3030-EC
Endcap w/hole	CHW-C-3030-ECH
Mounting Clip	CHW-C-3030-MC

CHW-C-3030S

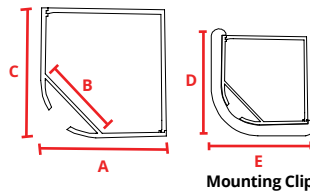

- A:** 1.18" (30.00mm)
B: 0.78" (20.20mm)
C: 1.18" (30.00mm)
D: 1.29" (32.77mm)
E: 1.29" (32.77mm)



MATERIAL

Anodized Aluminum



DESCRIPTION

45 degree channel with square lens.



LENGTH

2 meter



LENS TYPES

Clear	CHW-C-3030S-CC
Frosted	CHW-C-3030S-CF
Milky	CHW-C-3030S-CM

ACCESSORIES

Endcap	CHW-C-3030S-EC
Endcap w/hole	CHW-C-3030S-ECH
Mounting Clip	CHW-C-3030S-MC

CHW-S/H-3535

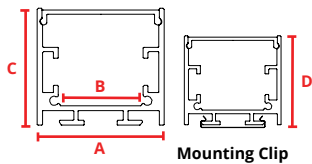

- A:** 1.39" (35.25mm)
B: 0.96" (24.50mm)
C: 1.39" (35.25mm)
D: 1.54" (39.00mm)

*Must specify for hanging or surface mount application.



MATERIAL

Anodized Aluminum



DESCRIPTION

Wide and deep surface mounted or hanging channel. Eliminates visible LED nodes for most FLEXDC products when used with a milky lens.



LENGTH

2 meter



LENS TYPES

Frosted	CHW-35mm-CF
Milky	CHW-35mm-CM

ACCESSORIES

Endcap	CHW-S-3535-EC
Endcap w/hole	CHW-S-3535-ECH
Mounting Clip	CHW-S-3535-MC
Hanging Hardware	CHW-SH-3535-MW
Bracket Straight	CHW-S-XX35-BS
Bracket 90° Flat	CHW-S-XX35-B90F
Bracket 90° Raised	CHW-S-XX35-B90R
End Cap for FLEX AC	CHW-S-3535-ECAC
Mounting Clip for FLEX AC	CHW-S-3535-MCAC
VHB Tape	VHBTAPE.AC

CHW-R-4435

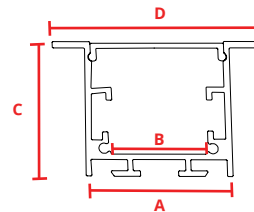

- A:** 1.39" (35.25mm)
B: 0.96" (24.50mm)
C: 1.39" (35.25mm)
D: 2.00" (51.04mm)



MATERIAL

Anodized Aluminum



DESCRIPTION

Wide and deep recessed channel. Eliminates visible LED nodes for most FLEXDC products when used with a milky lens. Can be securely and conveniently mounted with CHW-R-4435-SC spring clip.



LENGTH

2 meter



LENS TYPES

Frosted	CHW-35mm-CF
Milky	CHW-35mm-CM

ACCESSORIES

Endcap	CHW-R-4435-EC
Endcap w/hole	CHW-R-4435-ECH
Mounting Clip	CHW-R-4435-SC
Bracket Straight	CHW-S-XX35-BS
Bracket 90° Flat	CHW-S-XX35-B90F
Bracket 90° Raised	CHW-S-XX35-B90R
End Cap for FLEX AC	CHW-R-4435-ECAC
Mounting Clip for FLEX AC	CHW-R-4435-MCAC
VHB Tape	VHBTAPE.AC

CHW-S/H-2027

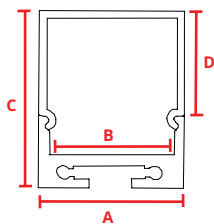

- A:** 0.79" (20.30mm)
B: 0.66" (16.70mm)
C: 1.06" (27.00mm)
D: 0.76" (19.50mm)

*Must specify for hanging or surface mount application.



MATERIAL

Anodized Aluminum



DESCRIPTION

Small surfaced mounted or hanging channel with wrap around lens.



LENGTH

2 meter



LENS TYPES

Clear	CHW-SH-2027-CC
Frosted	CHW-SH-2027-CF
Milky	CHW-SH-2027-CM

ACCESSORIES

Endcap	CHW-SH-2027-EC
End Cap w/hole	CHW-SH-2027-ECH
Hanging Hardware	CHW-SH-MW
Bracket Straight	CHW-SH-BS
Bracket 90° Flat	CHW-SH-B90F
Bracket 90° Raised	CHW-SH-B90R

CHW-S/H-3561

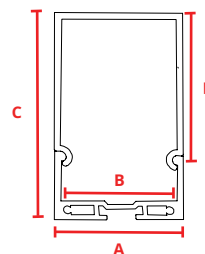

- A:** 1.38" (35.00mm)
B: 1.24" (31.40mm)
C: 2.43" (61.70mm)
D: 1.57" (39.90mm)

*Must specify for hanging or surface mount application.



MATERIAL

Anodized Aluminum



DESCRIPTION

Large surface mounted or hanging channel with wrap around lens.



LENGTH

2 meter



LENS TYPES

Milky	CHW-SH-3561-CM
-------	----------------

ACCESSORIES

Endcap	CHW-SH-3561-EC
End Cap w/hole	CHW-SH-3561-ECH
Hanging Hardware	CHW-SH-MW
Bracket Straight	CHW-SH-BS
Bracket 90° Flat	CHW-SH-B90F
Bracket 90° Raised	CHW-SH-B90R

MOUNTING OPTIONS - COMPATIBLE CHANNELS

- Not Blended
 Blended w/Milky Lens
 1 Configuration 1
 1a Configuration 1 with Auxiliary Housing Accessory
 2 Configuration 2
 3 Configuration 3

CHW-S/H-7532

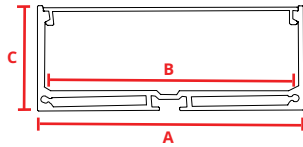

- A:** 2.95" (75.00mm)
B: 2.52" (64.00mm)
C: 1.26" (32.00mm)

*Must specify for hanging or surface mount application.



MATERIAL
Anodized Aluminum



DESCRIPTION
Wide surface mounted or hanging channel with flat lens.



LENGTH
2 meter



LENS TYPES
Frosted CHW-SH-7532-CF

ACCESSORIES
 Endcap CHW-SH-7532-EC
 Endcap w/hole CHW-SH-7532-ECH
 Hanging Hardware CHW-SH-MW
 Bracket Straight CHW-SH-BS
 Bracket 90° Flat CHW-SH-B90F
 Bracket 90° Raised CHW-SH-B90R

CHW-S-2623

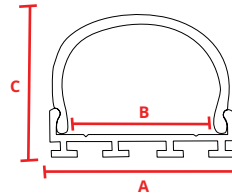

- A:** 1.03" (26.20mm)
B: 0.80" (20.35mm)
C: 0.89" (22.76mm)



MATERIAL
Anodized Aluminum



DESCRIPTION
Surface mounted channel with wrap around lens.



LENGTH
2 meter



LENS TYPES
Milky CHW-S-2623-CM

ACCESSORIES
 Endcap CHW-S-2623-EC
 Endcap w/hole CHW-S-2623-ECH

CHW-S/H-3030

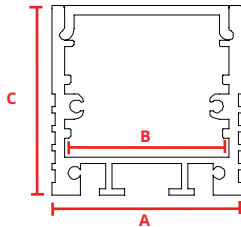

- A:** 1.18" (30.00mm)
B: 1.01" (25.60mm)
C: 1.18" (30.00mm)

*Must specify for hanging or surface mount application.



MATERIAL
Anodized Aluminum



DESCRIPTION
Wide and deep surface mounted or hanging channel with flat lens for even blending.



LENGTH
2 meter



LENS TYPES
Milky CHW-SH-3030-CM

ACCESSORIES
 Endcap CHW-SH-3030-EC
 Endcap w/hole CHW-SH-3030-ECH
 Hanging Hardware CHW-SH-MW
 Bracket Straight CHW-SH-BS
 Bracket 90° Flat CHW-SH-B90F
 Bracket 90° Raised CHW-SH-B90R
 End Cap for FLEX AC CHW-SH-3030-ECAC
 Mounting Clip for FLEX AC CHW-SH-3030-MCAC
 VHB Tape VHBTAPE.AC

CHC-S-1921

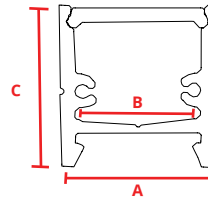

- A:** 0.76" (19.43mm)
B: 0.55" (14.09mm)
C: 0.84" (21.43mm)



MATERIAL
Anodized Aluminum



DESCRIPTION
Surface mount channel with flat lens. Mounts to ferrous and non-ferrous surfaces using magnets with no visible fasteners once mounted.



LENGTH
2 meter



LENS TYPES
Milky CHC-S-1921-CM

ACCESSORIES
 Anodized Aluminum Endcap CHC-S-1921-EC
 Anodized Aluminum Endcap w/hole CHC-S-1921-ECH
 Channel Mounted Magnet CHC-S-1921-MA
 Wall Mounted Magnet CHC-S-1921-M
 1" Mounting Plate CHC-S-1921-B1

CHSP-S-1618

Fits IP40 FLEX STP only

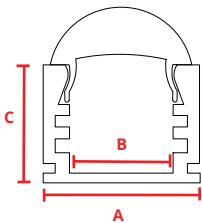

- A:** 0.63" (16.00mm)
B: 0.40" (10.16mm)
C: 0.49" (11.90mm)



MATERIAL
Anodized Aluminum



DESCRIPTION
Includes an aluminum insert that allows selection between (4) different beamspreads based on the position of the insert.



LENGTH
2 meter



LENS TYPES
Focusing Lens CHSP-S-1618-CFL

ACCESSORIES
 Endcap CHSP-S-1618-EC
 Endcap w/hole CHSP-S-1618-ECH
 Mounting Clip CHSP-S-1618-MC

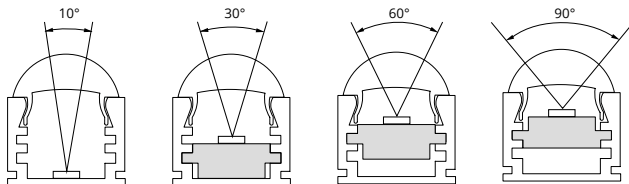

ACCESSORIES

LC-I2P-M

Indoor Lead Connector
(Male)

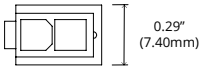
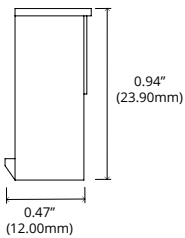
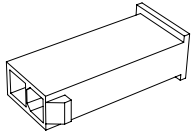

LC-I2P-F

Indoor Lead Connector
(Female)

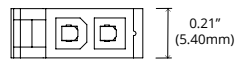
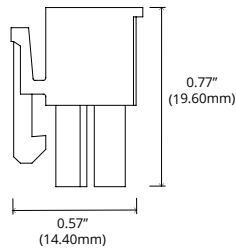
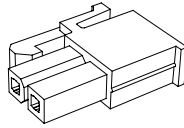

FLEX.ZIP

Strain Relief Clip

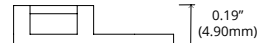
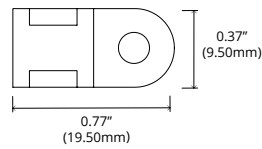
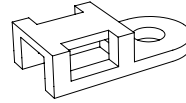

PFC-HO-1208-SS-KIT

1a Configuration 1 with
Auxiliary Housing Accessory

Flex Connect Auxiliary Housing
Accessory

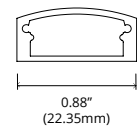
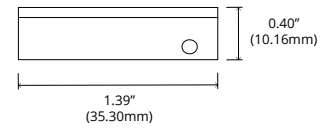
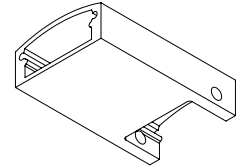

PFC-HO-1715-SS-KIT

1a Configuration 1 with
Auxiliary Housing Accessory

Flex Connect Auxiliary Housing
Accessory

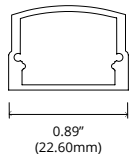
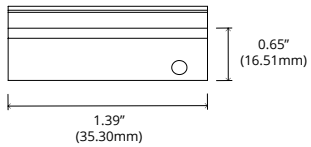
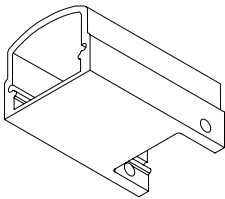

ACCESSORIES

FLEX STP.PFC-02.10

Field installed FLEX Connect® power feed
- 2 Conductor for 10mm Strip

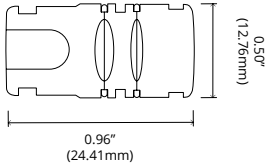

Fits in all channel **except:**

- CHS-R-1208
- CHS-R-1715
- CHS-S-1208
- CHS-S-1715
- CHS-C-1919
- CHS-C-1616
- CHC-S-1921
- CHSP-R-2970
- CHSP-S-1618
- CHSP-STEP-8142

FLEXSTP.BSC.02.10

Field installed FLEX Connect® butt splice -
2 Conductor for 10mm Strip

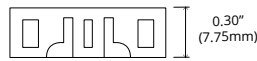
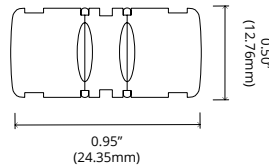

Fits in all channel **except:**

- CHS-R-1208
- CHS-R-1715
- CHS-S-1208
- CHS-S-1715
- CHS-C-1919
- CHS-C-1616
- CHC-S-1921
- CHSP-R-2970
- CHSP-S-1618
- CHSP-STEP-8142

LO-18G-2C-W-72

6' wire lead for FLEX Connect®
(not in-wall rated)

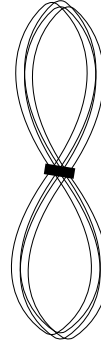

LP-18G-2C-W-72

6' Plenum rated wire lead for
FLEX Connect™

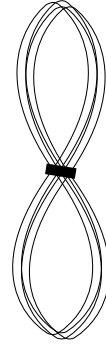

LO-18G-2C-W-SP

1000' spool of wire for
FLEX Connect® (not in-wall rated)

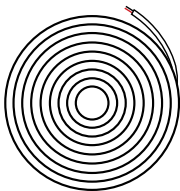

LP-18G-2C-W-SP

500' box of Plenum rated wire for
FLEX Connect®

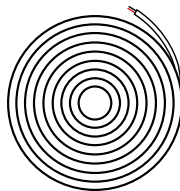

CONFIGURATION TYPES

① FLEX cut to length with FLEX Connect® Power Feeds for Field Termination, Channel uncut for field cutting

- Specify **FLEXConfig-1**
- Specify FLEX type and channel type
- FLEX factory cut to length, but not terminated
- One FLEX Connect® power feed connector and 6' lead provided per FLEX run
 - Uncut rolls of lead wire can also be provided (see page 8 for part #)
- Channel shipped uncut for field cutting.
- Specify number of butt splices (not shown - see page 8)
- IP68 not available in **FLEXConfig-1**
- JA8 2016 not available in **FLEXConfig-1**
- FLEXConfig-1** is quick ship if run lengths are provided at time of order. Take offs, if needed, will add lead time.
- The below channels are **NOT** compatible with FLEX Connect®:
 - Slim:**
 - CHS-R-1208
 - CHS-R-1715
 - CHS-S-1208
 - CHS-S-1715
 - CHS-C-1616
 - CHC-S-1921
 - Specialty:**
 - CHSP-R-2970
 - CHSP-S-1618
 - CHSP-STEP-8142

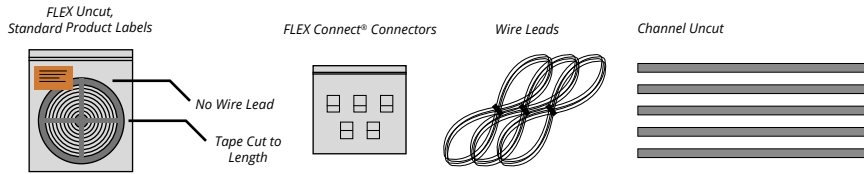

② CUT TO LENGTH WITH SOLDERED LEADS, ASSEMBLE ON-SITE^{1, 2, 3}

- Specify **FLEXConfig-2**
- Specify FLEX type and channel type
- Specify run lengths
- IP68 only available in **FLEXConfig-2**
- If no config is specified, and run lengths are provided, **FLEXConfig-2** will be used

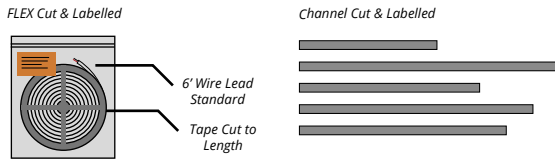

③ Pre-Assembled Factory Finished Fixtures^{1, 2}

- Specify **FLEXConfig-3**
- Fully assembled fixture
- ETL stamped and listed as a fixture
- 6.50' max length
- Standard 6' power lead unless otherwise specified
- The below channels **CANNOT** be factory assembled:
 - Slim:**
 - CHS-R-1208
 - CHS-R-1715
 - Wide:**
 - CHW-R-2010
 - CHW-S-2027
 - CHW-S-7532
 - CHW-S-2623
 - CHW-S-3030
 - CHW-S-3561

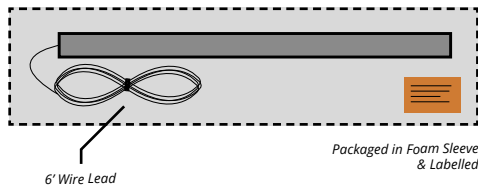

NOTES:

- Due to the nature of the FLEX STP product, specific lengths may not fall exactly on a cutting point. In this case, Optic Arts® will always cut to the smaller dimension unless otherwise specified.
- Unless otherwise specified, channel is cut 15mm longer than FLEX STP.
- Some on-site assembly required. See installation guides for details.

COMPATIBLE DRIVERS

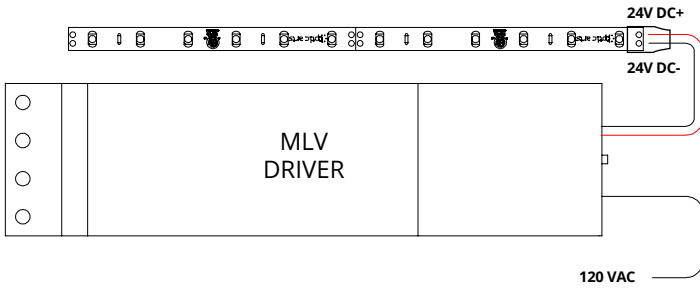

MLV (MLV)

PART	DESCRIPTION
ML10S24VDC	10W 120VAC DIMMABLE DRIVER
ML20S24VDC	20W 120VAC DIMMABLE DRIVER
ML35S24VDC	35W 120VAC DIMMABLE DRIVER
ML35S24VDC-277	35W 277VAC DIMMABLE DRIVER
ML40S24VDC	40W 120VAC DIMMABLE DRIVER
ML50S24VDC	50W 120VAC DIMMABLE DRIVER
ML50S24VDC-277	50W 277VAC DIMMABLE DRIVER
ML60S24VDC	60W 120VAC DIMMABLE DRIVER
ML75S24VDC	75W 120VAC DIMMABLE DRIVER
ML75S24VDC-277	75W 277VAC DIMMABLE DRIVER
ML96S24VDC	96W 120VAC DIMMABLE DRIVER
ML96S24VDC-277	96W 120VAC DIMMABLE DRIVER
EM2-200S24DC	200W 120VAC DIMMABLE DRIVER, 2 96W CIRCUITS
EM3-300S24DC	300W 120VAC DIMMABLE DRIVER, 3 96W CIRCUITS
EM2-200S24DC-277	200W 120VAC DIMMABLE DRIVER, 2 96W CIRCUITS
EM3-300S24DC-277	288W 120VAC DIMMABLE DRIVER, 3 96W CIRCUITS

DIMENSIONS

10W-50W	H 2.11"; W 7.38"; D 1.60"
60W-96W	H 3.93"; W 8.13"; D 1.59"
200-300W	H 5.69"; W 10.29"; D 3.13"

DIMMING PERFORMANCE

MLV DRIVER Dims to 20% on most MLV dimmers

NOTE: Must be loaded between 75%-100% of rated load to maintain FLEX DC warranty

120 VAC WIRING

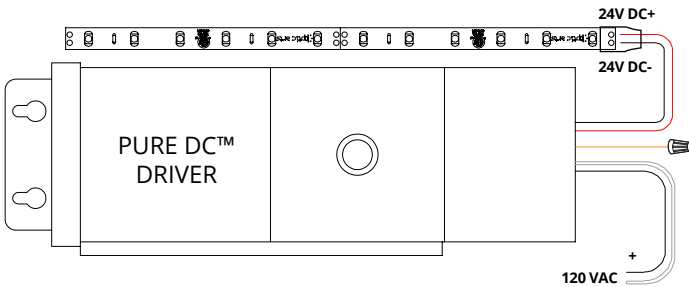

PURE DC™ MLV (PDC)

PART	DESCRIPTION
PDC.40.24	40W 120/277VAC PURE DC™ MLV DIMMABLE DRIVER
PDC.96.24	96W 120/277VAC PURE DC™ MLV DIMMABLE DRIVER

DIMENSIONS

40W	L 14.25"; W 3.00"; H 2.88"
96W	L 14.75"; W 4.31"; H 4.81"

DIMMING PERFORMANCE

PURE DC™ DRIVER Dims to 0.1% on most MLV dimmers

277 VAC WIRING

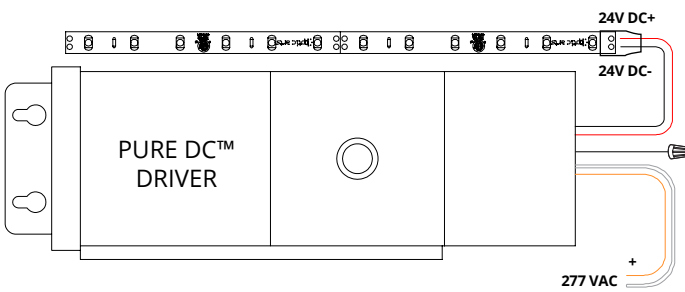

COMPATIBLE DRIVERS

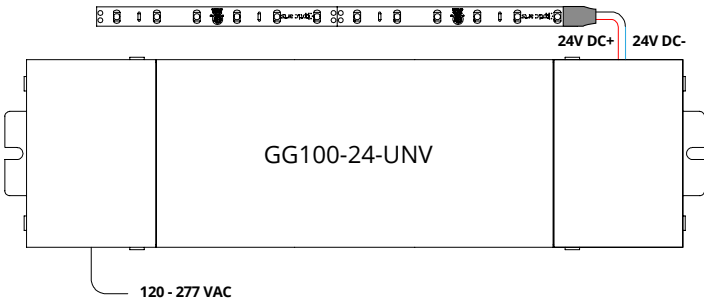

ELECTRONIC DRIVER - NON-DIM (ND)

PART	DESCRIPTION
GG100E-24-UNV	96W 120-277VAC ELECTRONIC DRIVER
DIMENSIONS	
ELECTRONIC DRIVER	H 3.00"; W 11.46"; D 1.30"
DIMMING PERFORMANCE	
ELECTRONIC DRIVER	Non-Dim

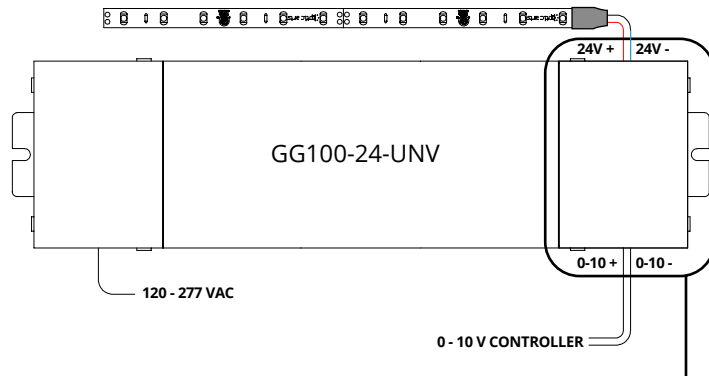

ELECTRONIC DRIVER W/0-10V MODULE (010)

PART	DESCRIPTION
GG100E-24-UNV-010V	96W 120-277VAC ELECTRONIC DRIVER WITH 0-10V DIMMING MODULE (SINK)
DIMENSIONS	
ELECTRONIC DRIVER - 0-10V	H 3.00"; W 11.46"; D 1.30"
DIMMING PERFORMANCE	
ELECTRONIC DRIVER - 0-10V	Dims below 1% on most 0-10V dimmers

FIELD INSTALLED IN LOW VOLTAGE WIRING COMPARTMENT

- Install DIM-010V Module in low voltage wiring compartment.
- Max number of 25 modules on one dimmer. Consult dimmer datasheet for maximum device limitation of a specific controller.

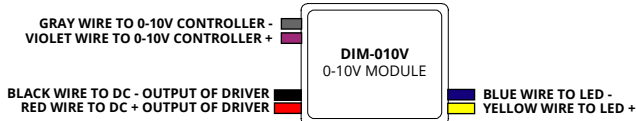

COMPATIBLE DRIVERS

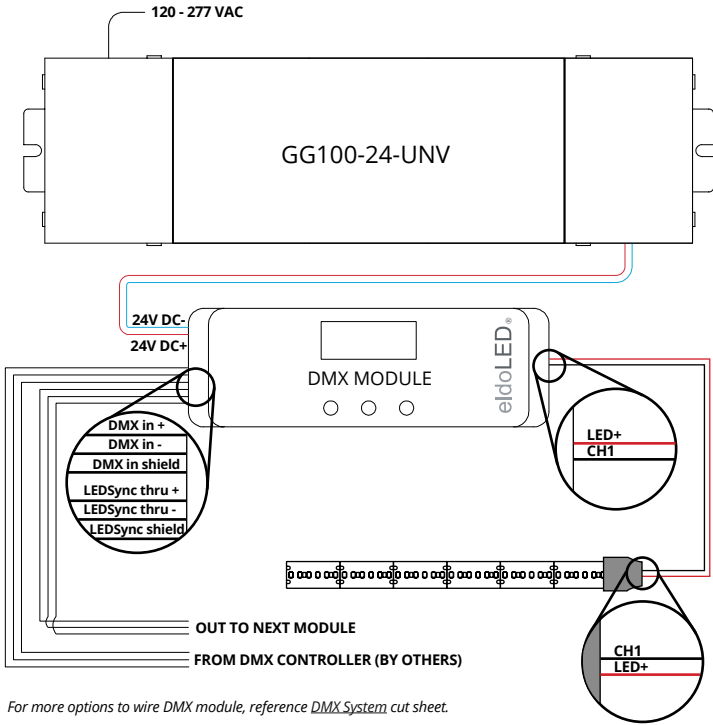

For more options to wire DMX module, reference [DMX System](#) cut sheet.

ELECTRONIC DRIVER W/DMX MODULE (DMX)

PART	DESCRIPTION
GG100E-24-UNV-DMX	96W 120-277VAC ELECTRONIC DRIVER WITH eldoLED DMX DIMMING MODULE

DIMENSIONS	
96W	H 3.00"; W 11.46"; D 1.30"
DMX MODULE	H 1.97"; W 6.02"; D 0.91"

*Must be installed in UL box (by others)

DIMMING PERFORMANCE	
ELECTRONIC DRIVER - DMX MODULE	Dims to 0.1% on most DMX systems

FLEX STP 70

Specification Sheet

COMPATIBLE DRIVERS

DIMMER WITH NEUTRAL

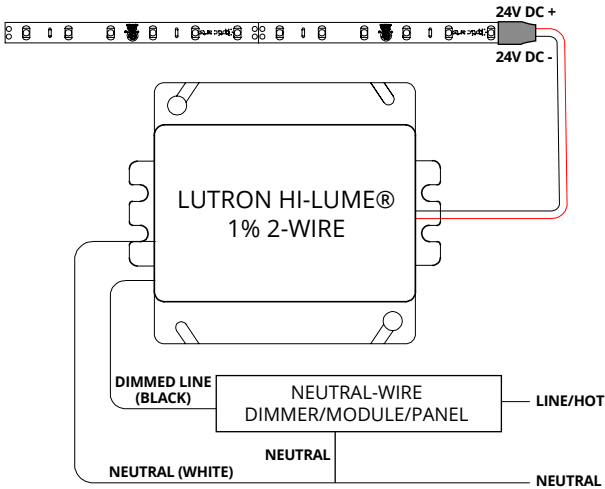

DIMMER WITHOUT NEUTRAL

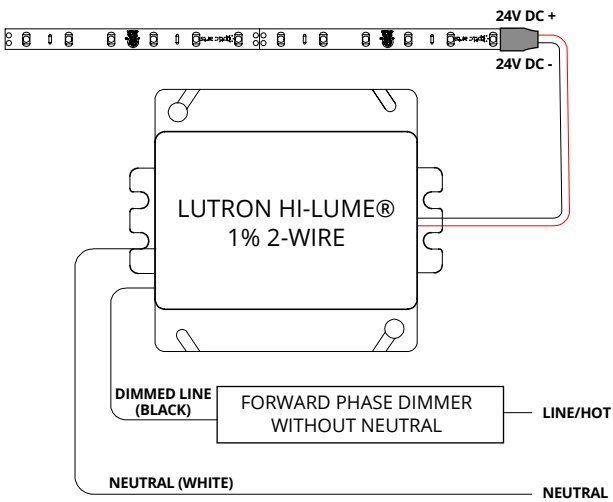

LUTRON HI-LUME® 1% 2-WIRE :
2-WIRE CONTROL FORWARD PHASE



PART	DESCRIPTION
LTEA4U1UKL-CV240	5-40W, 120VAC, 2-WIRE FORWARD PHASE DRIVER
DIMENSIONS	
LUTRON HI-LUME® 1% 2-WIRE	H 4.00"; W 4.89"; D 2.62"
DIMMING PERFORMANCE	
LUTRON HI-LUME® 1% 2-WIRE	Dims to 1% with compatible Lutron controls

COMPATIBLE DRIVERS

3-WIRE

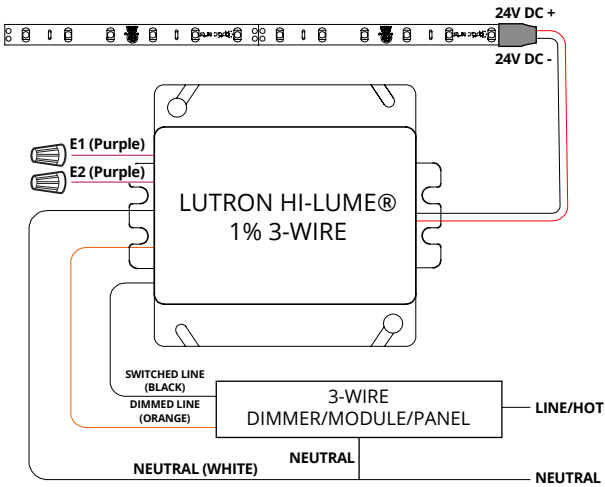

ECOSYSTEM

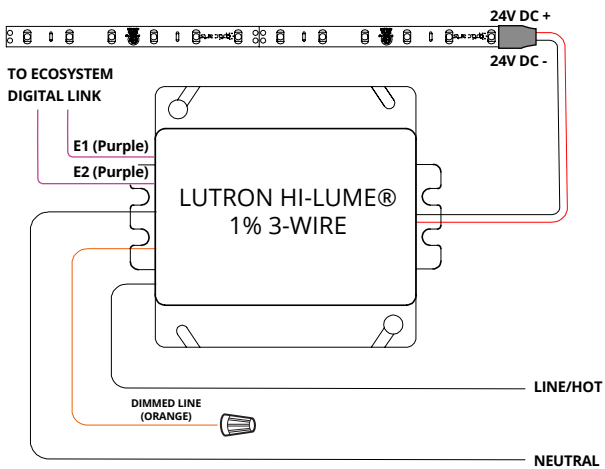

LUTRON HI-LUME® 1%: 3-WIRE/ECOSYSTEM



PART	DESCRIPTION
L3DA4U1UKL-CV240	5-40W, 120-277VAC, 3-WIRE/ECOSYSTEM DRIVER
DIMENSIONS	
LUTRON HI-LUME® 1% 3-WIRE/ ECOSYSTEM	H 4.00"; W 4.89"; D 2.62"
DIMMING PERFORMANCE	
LUTRON HI-LUME® 1% 3-WIRE/ECOSYSTEM	Dims to 1% with compatible Lutron controls

COMPATIBLE DRIVERS

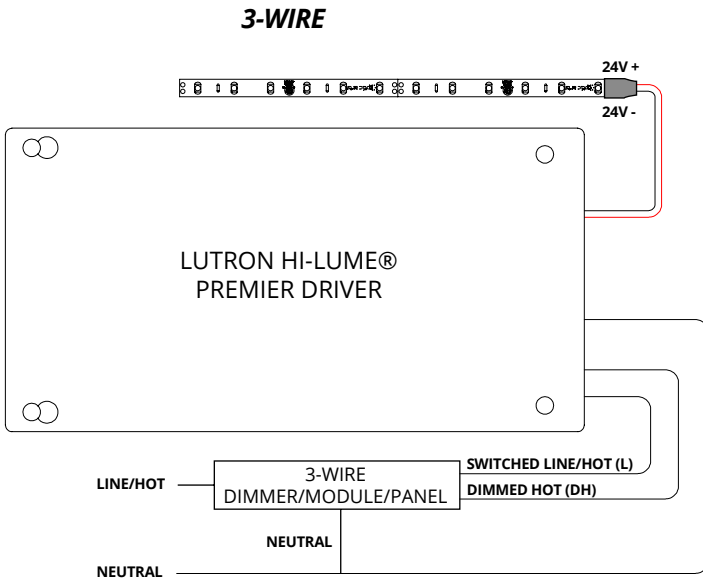

**LUTRON HI-LUME® PREMIER:
3-WIRE/ECOSYSTEM**



PART	DESCRIPTION
L3D0-96W24V-U	2-96W, 120-277VAC, 3-WIRE/ECOSYSTEM DRIVER

DIMENSIONS	
LUTRON HI-LUME® PREMIER	H 5.5"; W 10.5"; D 2.0"

DIMMING PERFORMANCE	
LUTRON HI-LUME® PREMIER	Dims to 0.1% with compatible Lutron controls
<i>NOTE: Lutron soft-on, fade to black technology available with Ecosystem Digital Control only.</i>	

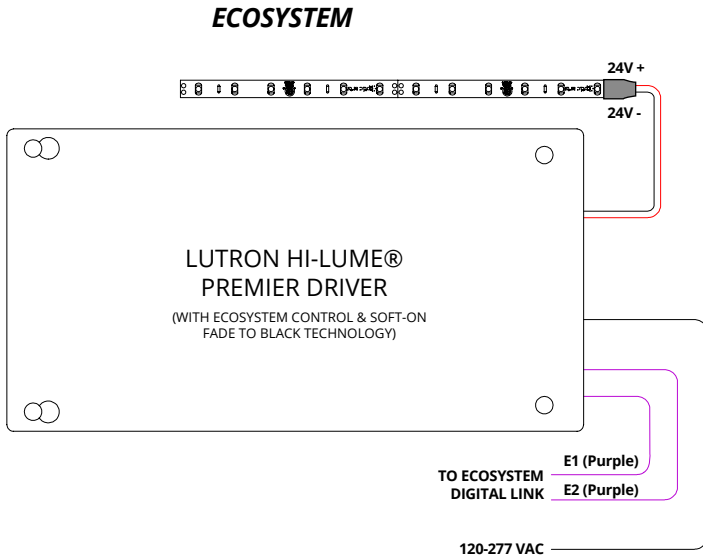

TM-30 - 1800K

Rf 85.7
Fidelity index Rf

Rg 86.4
Gammut index Rg

Hue Bin	R _f	Graphic shifts (%)	
		Chroma	Hue
1	93	-2%	0%
2	87	-3%	-5%
3	77	-6%	-10%
4	80	-14%	-8%
5	86	-17%	1%
6	73	-11%	13%
7	77	-7%	12%
8	80	0%	14%
9	93	1%	3%
10	95	1%	-2%
11	87	-2%	-7%
12	85	-3%	-8%
13	82	-7%	-11%
14	83	-13%	-10%
15	87	-8%	2%
16	88	-6%	3%

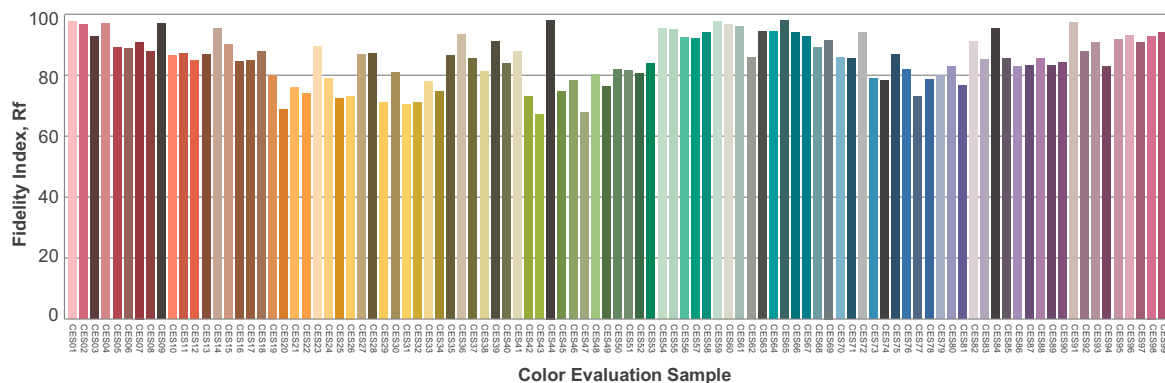
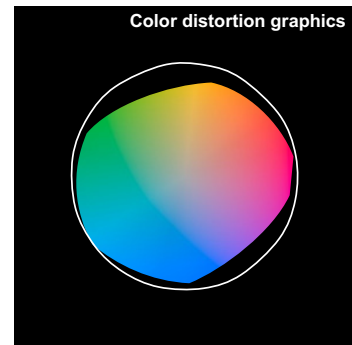
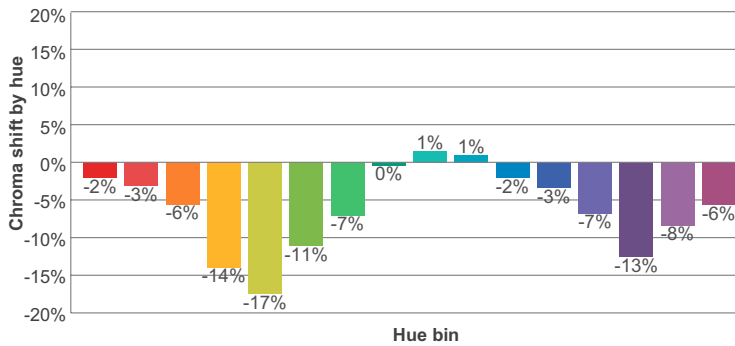
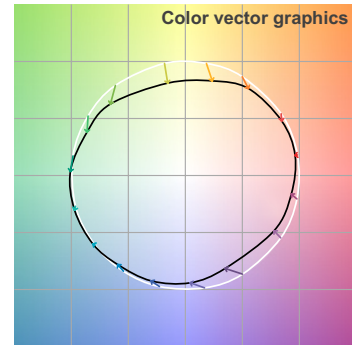
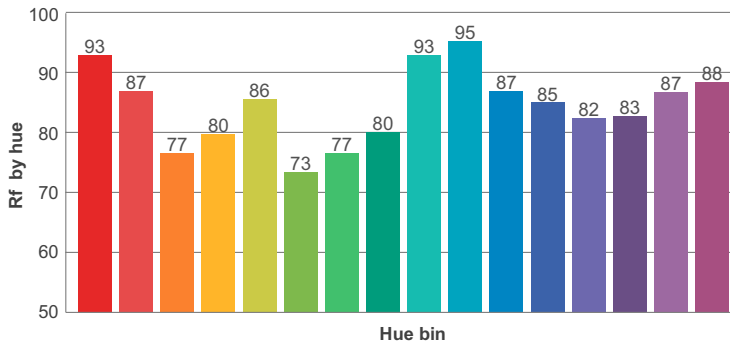
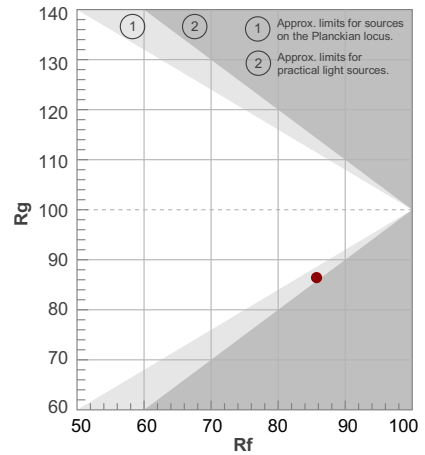

FLEX STP 70

Specification Sheet

TM-30 - 2350K

Rf 94.5
Fidelity index Rf

Rg 102.9
Gammut index Rg

Hue Bin	R _f	Graphic shifts (%)	
		Chroma	Hue
1	96	-1%	1%
2	97	0%	1%
3	94	1%	2%
4	95	-1%	-1%
5	95	0%	1%
6	94	3%	1%
7	95	1%	0%
8	97	2%	-1%
9	96	1%	2%
10	96	1%	2%
11	92	4%	3%
12	93	4%	-1%
13	91	3%	-7%
14	90	3%	-6%
15	95	0%	-2%
16	90	1%	-7%

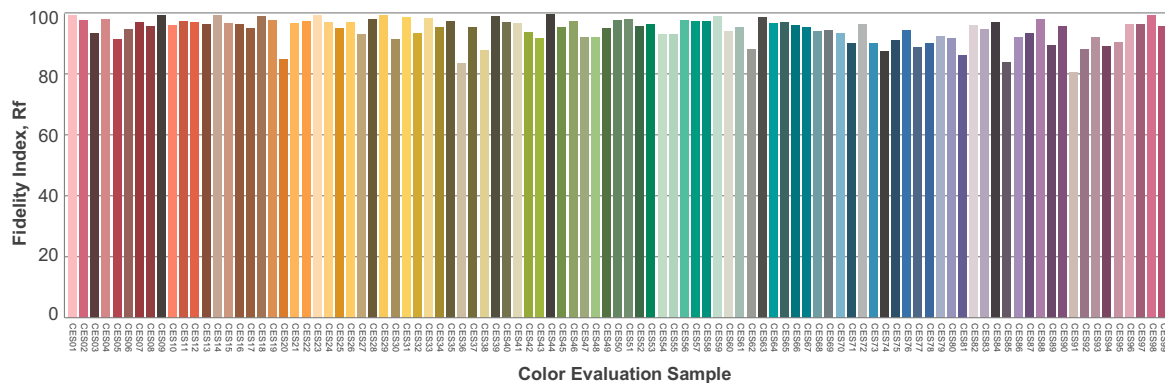
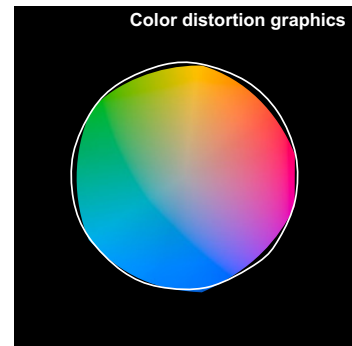
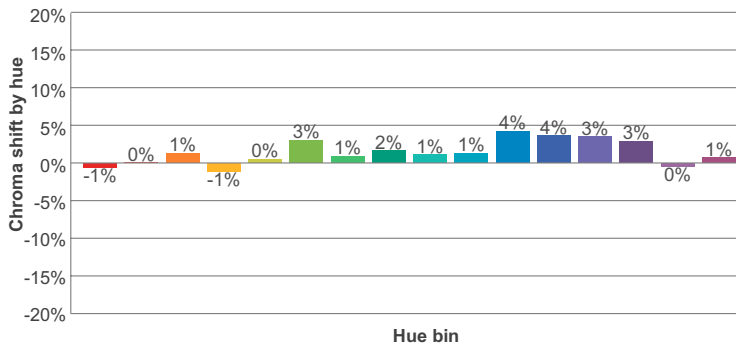
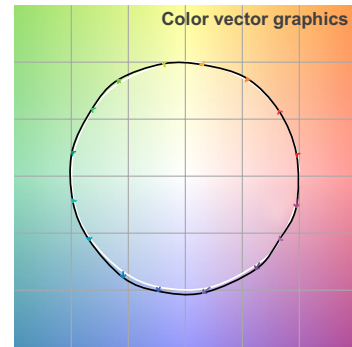
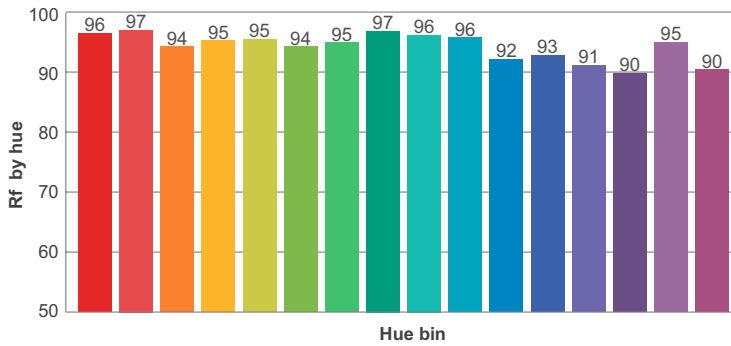
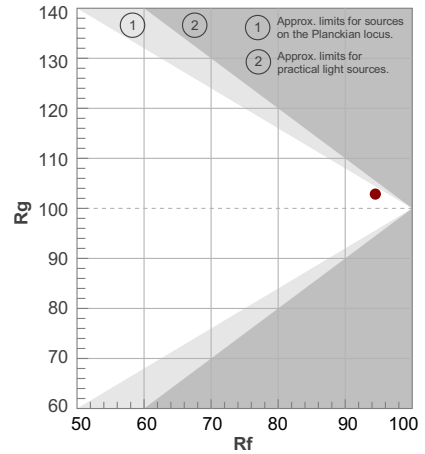

TM-30 - 2750K

Rf 93.3
Fidelity index Rf

Rg 101.2
Gammut index Rg

Hue Bin	R _f	Graphic shifts (%)	
		Chroma	Hue
1	95	-1%	1%
2	97	0%	1%
3	95	0%	2%
4	93	-3%	-1%
5	95	-1%	1%
6	97	1%	0%
7	92	-2%	2%
8	98	0%	1%
9	93	0%	4%
10	90	1%	6%
11	89	4%	6%
12	91	5%	0%
13	94	2%	-3%
14	91	4%	-5%
15	94	-1%	-1%
16	88	1%	-8%

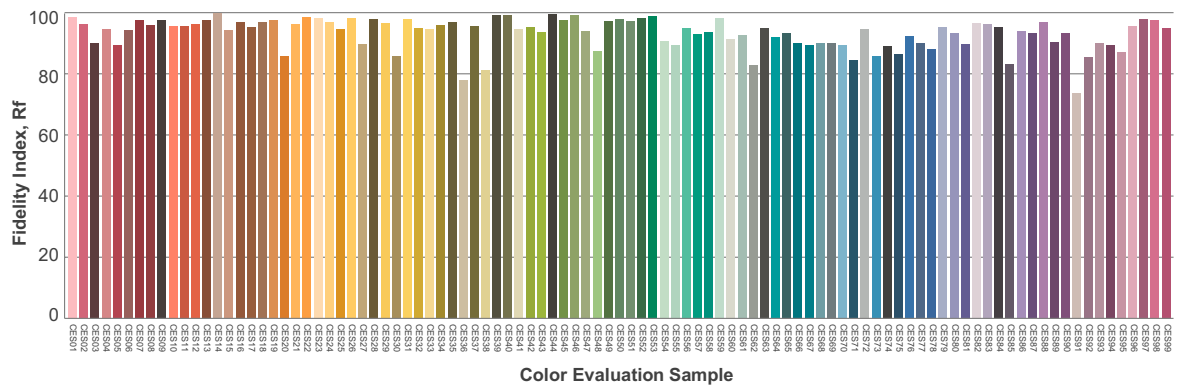
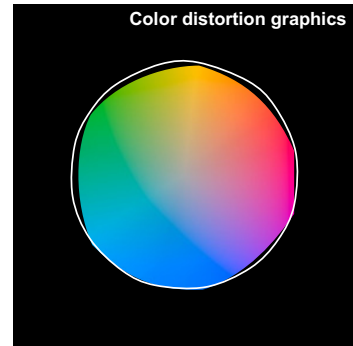
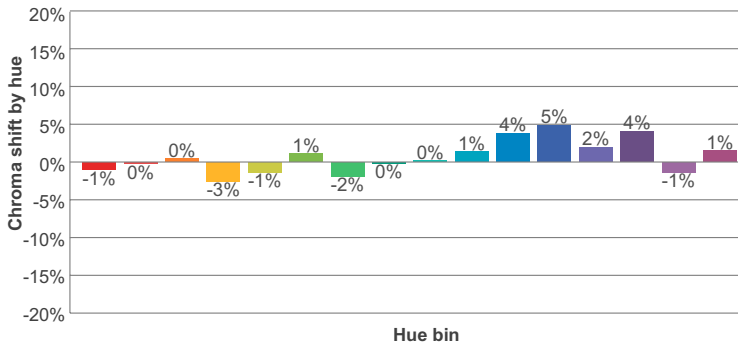
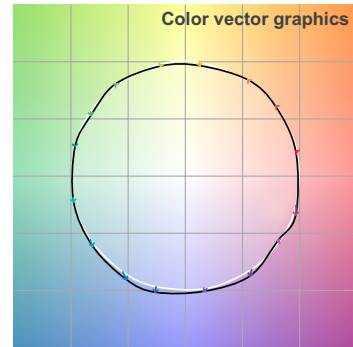
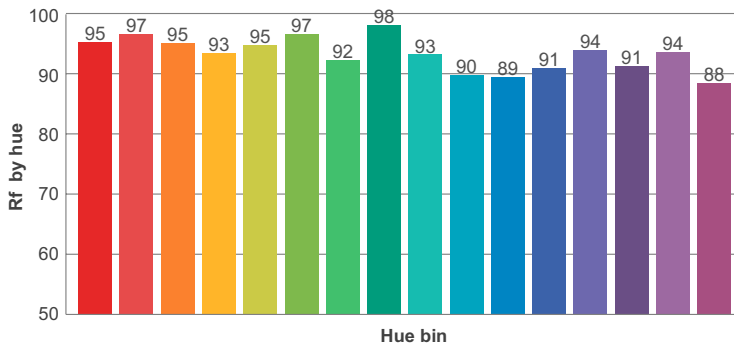
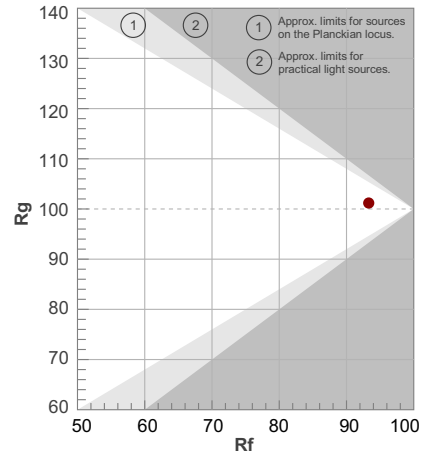

TM-30 - 2930K

Rf 91.3
Fidelity index Rf

Rg 99.5
Gammut index Rg

Hue Bin	R _f	Graphic shifts (%)	
		Chroma	Hue
1	93	-2%	2%
2	95	0%	1%
3	95	0%	1%
4	91	-4%	-3%
5	94	-3%	0%
6	96	-1%	0%
7	89	-4%	2%
8	95	-1%	4%
9	89	0%	6%
10	86	2%	8%
11	87	5%	7%
12	90	5%	0%
13	93	1%	-5%
14	90	3%	-6%
15	91	-3%	0%
16	87	1%	-9%

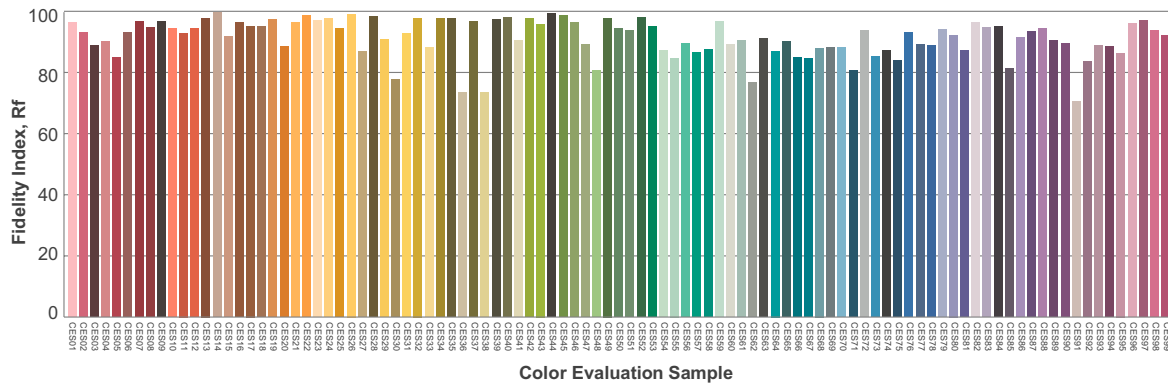
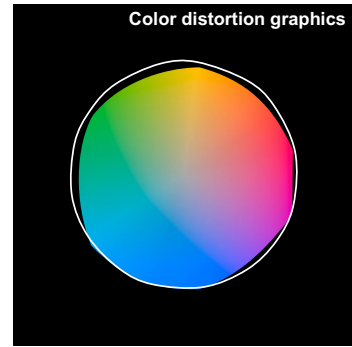
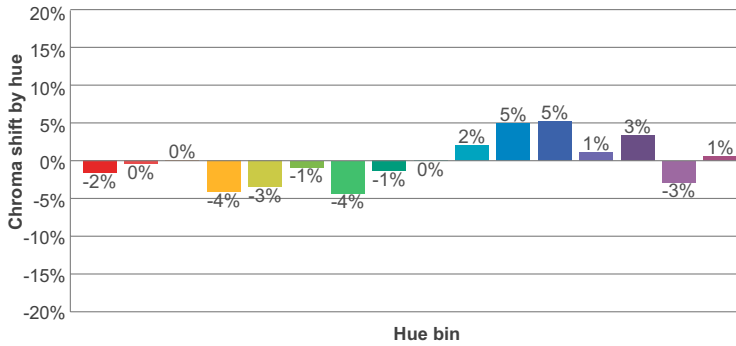
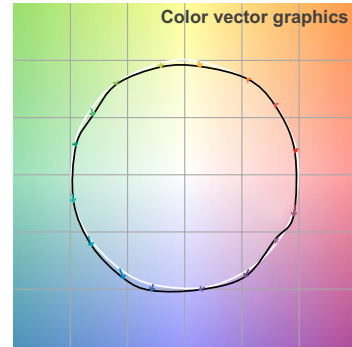
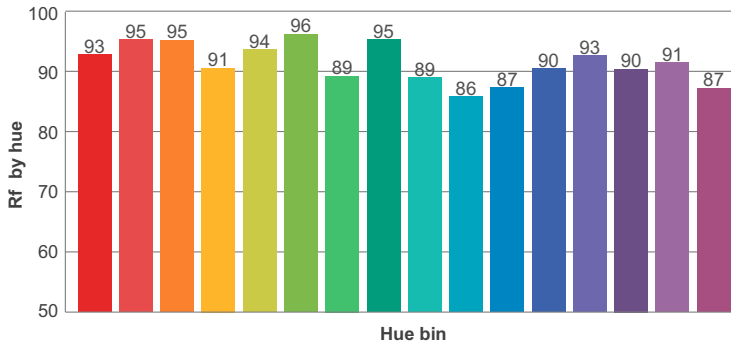
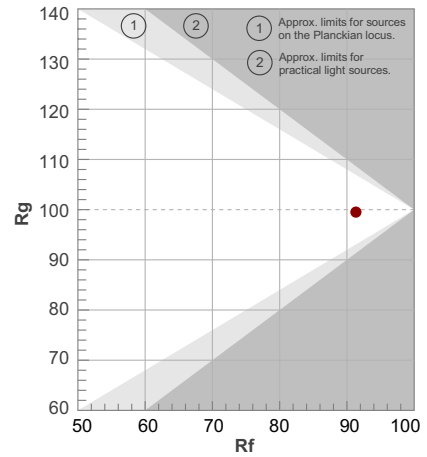

TM-30 - 3550K

Rf 91.9
Fidelity index Rf

Rg 101.0
Gammut index Rg

Hue Bin	R _f	Graphic shifts (%)	
		Chroma	Hue
1	95	0%	1%
2	97	0%	0%
3	95	0%	1%
4	93	-2%	0%
5	91	-4%	0%
6	96	0%	1%
7	94	-3%	2%
8	95	-1%	2%
9	91	-1%	5%
10	86	0%	9%
11	85	4%	9%
12	89	4%	3%
13	96	2%	-1%
14	92	6%	-2%
15	91	2%	-2%
16	89	2%	-5%

