



**FLEX STP 20** is a high performance flexible LED fixture distinguished by its extremely tight LED pitch and ability to blend in shallow channels, making it perfect for direct view applications.

## ELECTRICAL

<b>Input Voltage</b>	24VDC
<b>Dimming Options</b>	<ul style="list-style-type: none"> <li>• PURE DC™</li> <li>• MLV</li> <li>• 0-10V</li> <li>• DMX</li> <li>• Lutron (2-WIRE, 3-WIRE, EcoSystem)</li> </ul>
<b>Power Consumption</b>	2.0 Watts per foot
<b>Wire Size</b>	20AWG, 2 wire
<b>Regulatory</b>	<p><b>ETL</b> - Conforms to UL Std. 2108; Certified to CSA Std. C22.2 No. 9.0</p> <p><b>Title 24</b> - Selected models are JA8 2016 compliant when used with 0-10V, DMX, or Lutron Premier dimming.</p>

## PHYSICAL

<b>Field Cuttable</b>	Every 0.90" (22.86mm)
<b>Operating Temperature</b>	-20° C (-40°F) to +50° C (+122°F)
<b>Environment</b>	<b>IP20</b> - Dry Location
<b>Maximum Single Run Length</b>	40.00' (Up to 48' total on a 96W driver)
<b>Dimensions (WxH)</b>	0.39" (10.00mm) x 0.07" (1.78mm)

## ACCESSORIES

<b>Channels</b>	Optic Arts® Channel (pg. 3-6)
<b>Mounting Clips</b>	FLEXMNT.SIL.EXT12 (pg. 7)
<b>Connectors</b>	LC-I2P-M, LC-I2P-F (pg. 7)
<b>Strain Relief</b>	FLEX.ZIP (pg. 7)
<b>FLEXConfig-1 Accessories</b>	FLEXSTP.PFC.02.08, FLEXSTP.BSC.02.08, LO-18G-2C-W-72, LP-18G-2C-W-72, LO-18G-2C-W-SP, LP-18G-2C-W-SP (pg. 8)

## LUMEN OUTPUT

<b>1800K</b>	119.00 lm/ft 59.50 lm/Watt
<b>2350K</b>	158.00 lm/ft 79.00 lm/Watt
<b>2750K JA8 2016<sup>1</sup></b>	177.00 lm/ft 88.50 lm/Watt
<b>2930K JA8 2016<sup>1</sup></b>	189.00 lm/ft 94.50 lm/Watt
<b>3550K JA8 2016<sup>1</sup></b>	189.00 lm/ft 94.50 lm/Watt

Note: Stated lumen values have a tolerance of +/- 10%.

1: JA8 2016 when used with 0-10V, DMX, or Lutron Premier dimming.

## PERFORMANCE

<b>CRI</b>	<b>2350-3550K</b> = 95+, <b>1800K</b> = 90+
<b>TM-30</b>	See pages 16-20
<b>Lumen Maintenance</b>	When used in Optic Arts® CHS-S-1208 or larger channel: 50,000 Hours L70
<b>Binning Tolerance</b>	+/- 100K
<b>Warranty</b>	5 years

## PART NUMBER BUILDER

SERIES	+	IP RATING	+	COLOR	+	VOLTAGE	+	WATTAGE	+	CONFIGURATION	+	LENGTH
FLEXSTP		20 = IP20 - Dry Location		18 = 1800K 23 = 2350K 27 = 2750K <sup>1</sup> 29 = 2930K <sup>1</sup> 35 = 3550K <sup>1</sup>		24 = 24 VDC		20 = 2.0W		FLC1 = FLEX Config 1 FLC2 = FLEX Config 2 FLC3 = FLEX Config 3		XX = Custom Length

1: JA8 2016 when used with 0-10V, DMX, or Lutron Premier dimming.



## DIMENSIONS

Optic Arts® cuts all FLEX STP and Channel products to length per customer specifications. Each length of FLEX STP is fitted with a 6' wire lead (custom lengths available upon request) and packaged on a reel in an anti-static bag. Bags are labeled with fixture type, length and location (if applicable). Each piece of channel is labeled with fixture type, length and location (if applicable), and is bundled by fixture type.

- Due to the nature of the FLEX STP product, specific lengths may not fall exactly on a cutting point. In this case, Optic Arts® will always cut to the smaller dimension unless otherwise specified.
- Unless otherwise specified, channel is cut 15mm longer than FLEX STP.
- Some on-site assembly required. See installation guides for details.

### INDOOR FLEX STP 20

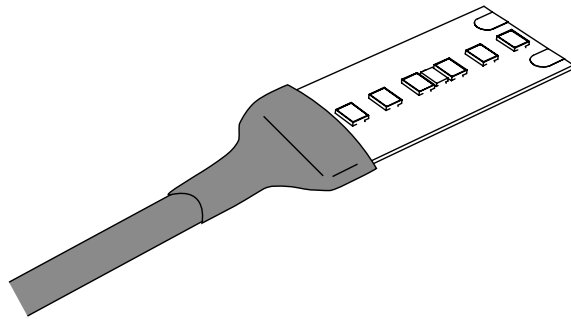
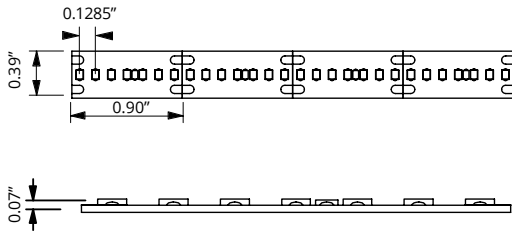

#### INDOOR DIMENSIONS

Width	0.39" (10.05mm)
Height	0.07" (1.78mm)
Cuttable Segment Length	0.90" (22.86mm)
Pitch Length	0.1285" (3.26mm)
Max Run Length	40.00' (12192.00mm)

### INDOOR FLEX STP 20

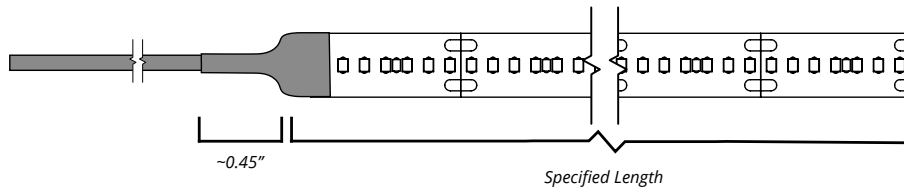

## KEY

### CHANNEL PART NUMBER BREAKDOWN:

CHS	+	R	+	1208
SERIES		APPLICATION		DIMENSIONS
CHS = Slim Channel CHW = Wide Channel		S = Surface Mount R = Recessed Mount C = Corner Mount H = Hanging Mount		XXXX = W x H (mm)

### CHS-R-1208

• Click on channel titles below to access complete channel cut sheets

### DIFFUSION LEVEL:

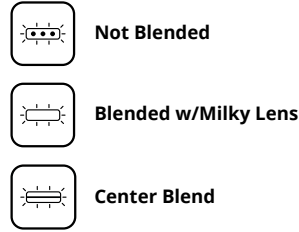

### CONFIGURATION:

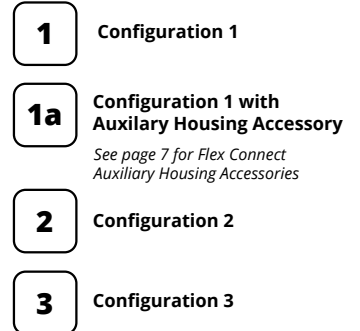

### CHS-R-1208

*Fits IP40 FLEX STP only*

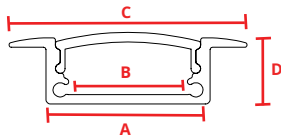

- A:** 0.68" (17.25mm)
- B:** 0.50" (12.59mm)
- C:** 0.98" (25.00mm)
- D:** 0.34" (8.60mm)



**2**

<b>MATERIAL</b>	Anodized Aluminum						
<b>DESCRIPTION</b>	Slim and shallow recessed channel.						
<b>LENGTH</b>	2 meter						
<b>LENS TYPES</b>	<table border="0"> <tr><td>Clear</td><td>CHS-12mm-CC</td></tr> <tr><td>Frosted</td><td>CHS-12mm-CF</td></tr> <tr><td>Milky</td><td>CHS-12mm-CM</td></tr> </table>	Clear	CHS-12mm-CC	Frosted	CHS-12mm-CF	Milky	CHS-12mm-CM
Clear	CHS-12mm-CC						
Frosted	CHS-12mm-CF						
Milky	CHS-12mm-CM						
<b>ACCESSORIES</b>	<table border="0"> <tr><td>Endcap</td><td>CHS-R-1208-EC</td></tr> <tr><td>Endcap w/hole</td><td>CHS-R-1208-ECH</td></tr> </table>	Endcap	CHS-R-1208-EC	Endcap w/hole	CHS-R-1208-ECH		
Endcap	CHS-R-1208-EC						
Endcap w/hole	CHS-R-1208-ECH						

### CHS-S-1208

*Fits IP40 FLEX STP only*

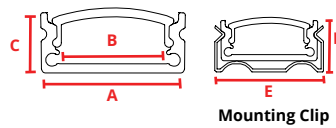

- A:** 0.68" (17.25mm)
- B:** 0.50" (12.59mm)
- C:** 0.34" (8.60mm)
- D:** 0.40" (12.70mm)
- E:** 0.78" (19.90mm)



**1a**

**2**

**3**

<b>MATERIAL</b>	Anodized Aluminum								
<b>DESCRIPTION</b>	Slim and shallow surface mounted channel.								
<b>LENGTH</b>	2 meter								
<b>LENS TYPES</b>	<table border="0"> <tr><td>Clear</td><td>CHS-12mm-CC</td></tr> <tr><td>Frosted</td><td>CHS-12mm-CF</td></tr> <tr><td>Milky</td><td>CHS-12mm-CM</td></tr> <tr><td>Grazer</td><td>CHS-12mm-CG</td></tr> </table>	Clear	CHS-12mm-CC	Frosted	CHS-12mm-CF	Milky	CHS-12mm-CM	Grazer	CHS-12mm-CG
Clear	CHS-12mm-CC								
Frosted	CHS-12mm-CF								
Milky	CHS-12mm-CM								
Grazer	CHS-12mm-CG								
<b>ACCESSORIES</b>	<table border="0"> <tr><td>Endcap</td><td>CHS-S-1208-EC</td></tr> <tr><td>Endcap w/hole</td><td>CHS-S-1208-ECH</td></tr> <tr><td>Mounting Clip</td><td>CHS-S-1208-MC</td></tr> <tr><td>Rotating Mounting Clip</td><td>CHS-S-1208-MCR</td></tr> </table>	Endcap	CHS-S-1208-EC	Endcap w/hole	CHS-S-1208-ECH	Mounting Clip	CHS-S-1208-MC	Rotating Mounting Clip	CHS-S-1208-MCR
Endcap	CHS-S-1208-EC								
Endcap w/hole	CHS-S-1208-ECH								
Mounting Clip	CHS-S-1208-MC								
Rotating Mounting Clip	CHS-S-1208-MCR								

### CHS-C-1919

*Fits IP40 FLEX STP only*

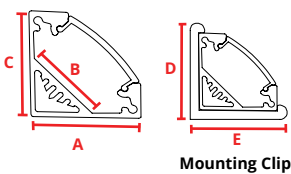

- A:** 0.73" (18.50mm)
- B:** 0.48" (12.20mm)
- C:** 0.73" (18.50mm)
- D:** 0.82" (20.82mm)
- E:** 0.82" (20.82mm)



**1**

**2**

**3**

<b>MATERIAL</b>	Anodized Aluminum						
<b>DESCRIPTION</b>	Slim corner mount channel.						
<b>LENGTH</b>	2 meter						
<b>LENS TYPES</b>	<table border="0"> <tr><td>Clear</td><td>CHS-12mm-CC</td></tr> <tr><td>Frosted</td><td>CHS-12mm-CF</td></tr> <tr><td>Milky</td><td>CHS-12mm-CM</td></tr> </table>	Clear	CHS-12mm-CC	Frosted	CHS-12mm-CF	Milky	CHS-12mm-CM
Clear	CHS-12mm-CC						
Frosted	CHS-12mm-CF						
Milky	CHS-12mm-CM						
<b>ACCESSORIES</b>	<table border="0"> <tr><td>Endcap</td><td>CHS-C-1919-EC</td></tr> <tr><td>Endcap w/hole</td><td>CHS-C-1919-ECH</td></tr> <tr><td>Mounting Clip</td><td>CHS-C-1919-MC</td></tr> </table>	Endcap	CHS-C-1919-EC	Endcap w/hole	CHS-C-1919-ECH	Mounting Clip	CHS-C-1919-MC
Endcap	CHS-C-1919-EC						
Endcap w/hole	CHS-C-1919-ECH						
Mounting Clip	CHS-C-1919-MC						

### CHS-R-1715

*Fits IP40 FLEX STP only*

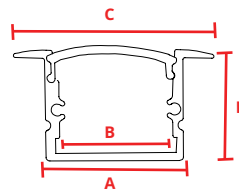

- A:** 0.68" (17.25mm)
- B:** 0.48" (12.30mm)
- C:** 0.98" (25.00mm)
- D:** 0.59" (15.05mm)



**2**

<b>MATERIAL</b>	Anodized Aluminum								
<b>DESCRIPTION</b>	Slim and deep recessed channel. Eliminates visible LED nodes when used with FLEXDC 3.0 and milk lens.								
<b>LENGTH</b>	2 meter								
<b>LENS TYPES</b>	<table border="0"> <tr><td>Clear</td><td>CHS-12mm-CC</td></tr> <tr><td>Frosted</td><td>CHS-12mm-CF</td></tr> <tr><td>Milky</td><td>CHS-12mm-CM</td></tr> <tr><td>Grazer</td><td>CHS-12mm-CG</td></tr> </table>	Clear	CHS-12mm-CC	Frosted	CHS-12mm-CF	Milky	CHS-12mm-CM	Grazer	CHS-12mm-CG
Clear	CHS-12mm-CC								
Frosted	CHS-12mm-CF								
Milky	CHS-12mm-CM								
Grazer	CHS-12mm-CG								
<b>ACCESSORIES</b>	<table border="0"> <tr><td>Endcap</td><td>CHS-R-1715-EC</td></tr> <tr><td>Endcap w/hole</td><td>CHS-R-1715-ECH</td></tr> </table>	Endcap	CHS-R-1715-EC	Endcap w/hole	CHS-R-1715-ECH				
Endcap	CHS-R-1715-EC								
Endcap w/hole	CHS-R-1715-ECH								

## MOUNTING OPTIONS - COMPATIBLE CHANNELS

- Not Blended  
 Blended w/Milky Lens  
 **1** Configuration 1  
 **1a** Configuration 1 with Auxiliary Housing Accessory  
 **2** Configuration 2  
 **3** Configuration 3

### CHS-S-1715

*Fits IP40 FLEX STP only*

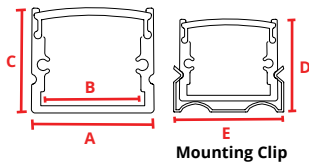

- A:** 0.68" (17.25mm)
- B:** 0.48" (12.30mm)
- C:** 0.59" (15.05mm)
- D:** 0.66" (16.76mm)
- E:** 0.78" (19.90mm)



#### MATERIAL

Anodized Aluminum



#### DESCRIPTION

Slim and deep surface mounted channel. Eliminates visible LED nodes when used with FLEXDC 3.0 and milky lens.



#### LENGTH

2 meter



#### LENS TYPES

Clear	CHS-12mm-CC
Frosted	CHS-12mm-CF
Milky	CHS-12mm-CM
Grazer	CHS-12mm-CG

#### ACCESSORIES

Endcap	CHS-S-1715-EC
Endcap w/hole	CHS-S-1715-ECH
Mounting Clip	CHS-S-1715-MC
Rotating Mounting Clip	CHS-S-1208-MCR

### CHS-C-1616

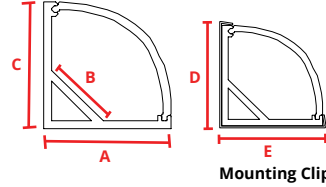

- A:** 0.63" (16.00mm)
- B:** 0.39" (10.00mm)
- C:** 0.63" (16.00mm)
- D:** 0.70" (17.78mm)
- E:** 0.70" (17.78mm)



#### MATERIAL

Anodized Aluminum



#### DESCRIPTION

Slim corner mount channel with rounded lens.



#### LENGTH

2 meter

#### LENS TYPES

Frosted	CHS-C-1616-CF
Milky	CHS-C-1616-CM

#### ACCESSORIES

Endcap	CHS-C-1616-EC
Endcap w/hole	CHS-C-1616-ECH
Mounting Clip	CHS-C-1616-MC

### CHS-S-1922S

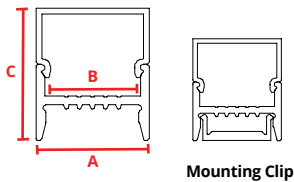

- A:** 0.77" (19.50mm)
- B:** 0.65" (16.50mm)
- C:** 0.86" (21.80mm)



#### MATERIAL

Anodized Aluminum



#### DESCRIPTION

Slim surface mounted channel with square wrap around lens. Mounting clip is fully concealed within fixture base.



#### LENGTH

2 meter



#### LENS TYPES

Milky	CHW-S-1922S-CM
-------	----------------

#### ACCESSORIES

Endcap	CHS-S-1922S-EC
Endcap w/hole	CHS-S-1922S-ECH
Mounting Clip	CHS-S-1922S-MC

### CHS-S-1922R

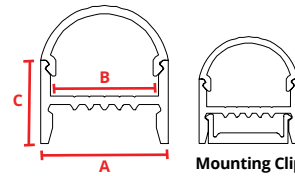

- A:** 0.77" (19.50mm)
- B:** 0.65" (16.50mm)
- C:** 0.86" (21.80mm)



#### MATERIAL

Anodized Aluminum



#### DESCRIPTION

Slim surface mounted channel with rounded wrap around lens. Mounting clip is fully concealed within fixture base.



#### LENGTH

2 meter



#### LENS TYPES

Milky	CHW-S-1922R-CM
-------	----------------

#### ACCESSORIES

Endcap	CHS-S-1922R-EC
Endcap w/hole	CHS-S-1922R-ECH
Mounting Clip	CHS-S-1922R-MC

### CHW-S-2010

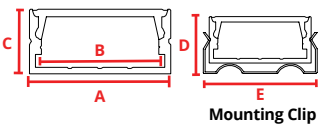

- A:** 0.93" (23.50mm)
- B:** 0.78" (20.00mm)
- C:** 0.39" (10.00mm)
- D:** 0.48" (12.19mm)
- E:** 1.02" (25.80mm)



#### MATERIAL

Anodized Aluminum



#### DESCRIPTION

Low profile surface mounted channel.



#### LENGTH

2 meter



#### LENS TYPES

Clear	CHW-S-2010-CC
Frosted	CHW-S-2010-CF
Milky	CHW-S-2010-CM

#### ACCESSORIES

Endcap	CHW-S-2010-EC
Endcap w/hole	CHW-S-2010-ECH
Mounting Clip	CHW-S-2010-MC
Rotating Mounting Clip	CHW-S-2010-MCR

### CHW-R-2010

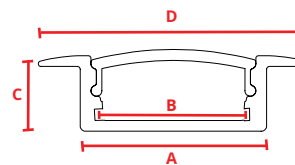

- A:** 0.93" (23.50mm)
- B:** 0.78" (20.00mm)
- C:** 0.39" (10.00mm)
- D:** 1.19" (30.24mm)



#### MATERIAL

Anodized Aluminum



#### DESCRIPTION

Recessed wide-profile channel.



#### LENGTH

2 meter

#### LENS TYPES

Clear	CHW-R-2010-CC
Frosted	CHW-R-2010-CF
Milky	CHW-R-2010-CM

#### ACCESSORIES

Endcap	CHW-R-2010-EC
Endcap w/hole	CHW-R-2010-ECH

## MOUNTING OPTIONS - COMPATIBLE CHANNELS

- Not Blended  
 Blended w/Milky Lens  
 **1** Configuration 1  
 **1a** Configuration 1 with Auxiliary Housing Accessory  
 **2** Configuration 2  
 **3** Configuration 3

### CHW-C-3030

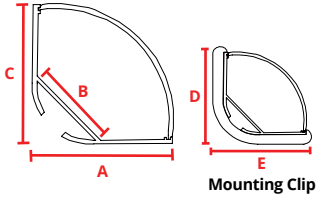

- A:** 1.18" (30.00mm)  
**B:** 0.78" (20.20mm)  
**C:** 1.18" (30.00mm)  
**D:** 1.29" (32.77mm)  
**E:** 1.29" (32.77mm)



#### MATERIAL

Anodized Aluminum



#### DESCRIPTION

45 degree channel with rounded lens.



#### LENGTH

2 meter



#### LENS TYPES

Clear	CHW-C-3030-CC
Frosted	CHW-C-3030-CF
Milky	CHW-C-3030-CM

#### ACCESSORIES

Endcap	CHW-C-3030-EC
Endcap w/hole	CHW-C-3030-ECH
Mounting Clip	CHW-C-3030-MC

### CHW-C-3030S

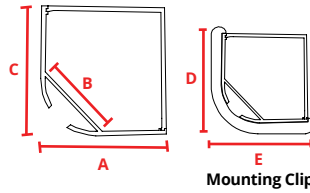

- A:** 1.18" (30.00mm)  
**B:** 0.78" (20.20mm)  
**C:** 1.18" (30.00mm)  
**D:** 1.29" (32.77mm)  
**E:** 1.29" (32.77mm)



#### MATERIAL

Anodized Aluminum



#### DESCRIPTION

45 degree channel with square lens.



#### LENGTH

2 meter



#### LENS TYPES

Clear	CHW-C-3030S-CC
Frosted	CHW-C-3030S-CF
Milky	CHW-C-3030S-CM

#### ACCESSORIES

Endcap	CHW-C-3030S-EC
Endcap w/hole	CHW-C-3030S-ECH
Mounting Clip	CHW-C-3030S-MC

### CHW-S/H-3535

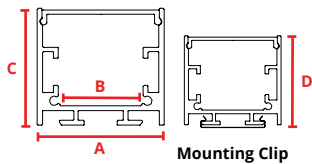

- A:** 1.39" (35.25mm)  
**B:** 0.96" (24.50mm)  
**C:** 1.39" (35.25mm)  
**D:** 1.54" (39.00mm)

\*Must specify for hanging or surface mount application.



#### MATERIAL

Anodized Aluminum



#### DESCRIPTION

Wide and deep surface mounted or hanging channel. Eliminates visible LED nodes for most FLEXDC products when used with a milky lens.



#### LENGTH

2 meter



#### LENS TYPES

Frosted	CHW-35mm-CF
Milky	CHW-35mm-CM

#### ACCESSORIES

Endcap	CHW-S-3535-EC
Endcap w/hole	CHW-S-3535-ECH
Mounting Clip	CHW-S-3535-MC
Hanging Hardware	CHW-SH-3535-MW
Bracket Straight	CHW-S-XX35-BS
Bracket 90° Flat	CHW-S-XX35-B90F
Bracket 90° Raised	CHW-S-XX35-B90R
End Cap for FLEX AC	CHW-S-3535-ECAC
Mounting Clip for FLEX AC	CHW-S-3535-MCAC
VHB Tape	VHBTAPE-AC

### CHW-R-4435

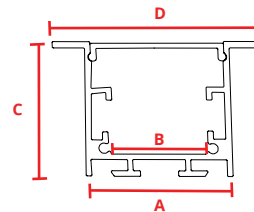

- A:** 1.39" (35.25mm)  
**B:** 0.96" (24.50mm)  
**C:** 1.39" (35.25mm)  
**D:** 2.00" (51.04mm)



#### MATERIAL

Anodized Aluminum



#### DESCRIPTION

Wide and deep recessed channel. Eliminates visible LED nodes for most FLEXDC products when used with a milky lens. Can be securely and conveniently mounted with CHW-R-4435-SC spring clip.



#### LENGTH

2 meter



#### LENS TYPES

Frosted	CHW-35mm-CF
Milky	CHW-35mm-CM

#### ACCESSORIES

Endcap	CHW-R-4435-EC
Endcap w/hole	CHW-R-4435-ECH
Mounting Clip	CHW-R-4435-SC
Bracket Straight	CHW-S-XX35-BS
Bracket 90° Flat	CHW-S-XX35-B90F
Bracket 90° Raised	CHW-S-XX35-B90R
End Cap for FLEX AC	CHW-R-4435-ECAC
Mounting Clip for FLEX AC	CHW-R-4435-MCAC
VHB Tape	VHBTAPE-AC

### CHW-S/H-2027

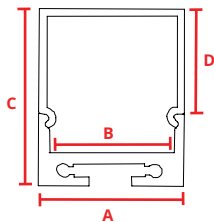

- A:** 0.79" (20.30mm)  
**B:** 0.66" (16.70mm)  
**C:** 1.06" (27.00mm)  
**D:** 0.76" (19.50mm)

\*Must specify for hanging or surface mount application.



#### MATERIAL

Anodized Aluminum



#### DESCRIPTION

Small surfaced mounted or hanging channel with wrap around lens.



#### LENGTH

2 meter



#### LENS TYPES

Clear	CHW-SH-2027-CC
Frosted	CHW-SH-2027-CF
Milky	CHW-SH-2027-CM

#### ACCESSORIES

Endcap	CHW-SH-2027-EC
End Cap w/hole	CHW-SH-2027-ECH
Hanging Hardware	CHW-SH-MW
Bracket Straight	CHW-SH-BS
Bracket 90° Flat	CHW-SH-B90F
Bracket 90° Raised	CHW-SH-B90R

### CHW-S/H-3561

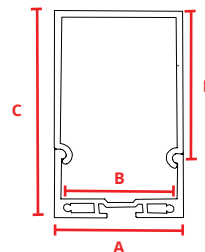

- A:** 1.38" (35.00mm)  
**B:** 1.24" (31.40mm)  
**C:** 2.43" (61.70mm)  
**D:** 1.57" (39.90mm)

\*Must specify for hanging or surface mount application.



#### MATERIAL

Anodized Aluminum



#### DESCRIPTION

Large surface mounted or hanging channel with wrap around lens.



#### LENGTH

2 meter



#### LENS TYPES

Milky	CHW-SH-3561-CM
-------	----------------

#### ACCESSORIES

Endcap	CHW-SH-3561-EC
End Cap w/hole	CHW-SH-3561-ECH
Hanging Hardware	CHW-SH-MW
Bracket Straight	CHW-SH-BS
Bracket 90° Flat	CHW-SH-B90F
Bracket 90° Raised	CHW-SH-B90R

## MOUNTING OPTIONS - COMPATIBLE CHANNELS

- Not Blended  
 Blended w/Milky Lens  
 **1** Configuration 1  
 **1a** Configuration 1 with Auxiliary Housing Accessory  
 **2** Configuration 2  
 **3** Configuration 3

### CHW-S/H-7532

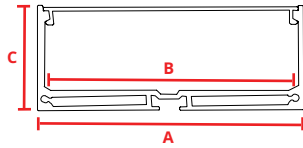

- A:** 2.95" (75.00mm)  
**B:** 2.52" (64.00mm)  
**C:** 1.26" (32.00mm)

\*Must specify for hanging or surface mount application.



**MATERIAL**  
Anodized Aluminum



**DESCRIPTION**  
Wide surface mounted or hanging channel with flat lens.



**LENGTH**  
2 meter



**LENS TYPES**  
Frosted CHW-SH-7532-CF

**ACCESSORIES**

**Endcap** CHW-SH-7532-EC  
**Endcap w/hole** CHW-SH-7532-ECH  
**Hanging Hardware** CHW-SH-MW  
**Bracket Straight** CHW-SH-BS  
**Bracket 90° Flat** CHW-SH-B90F  
**Bracket 90° Raised** CHW-SH-B90R

### CHW-S-2623

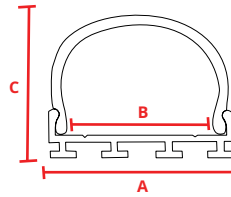

- A:** 1.03" (26.20mm)  
**B:** 0.80" (20.35mm)  
**C:** 0.89" (22.76mm)



**MATERIAL**  
Anodized Aluminum



**DESCRIPTION**  
Surface mounted channel with wrap around lens.



**LENGTH**  
2 meter



**LENS TYPES**  
Milky CHW-S-2623-CM

**ACCESSORIES**

**Endcap** CHW-S-2623-EC  
**Endcap w/hole** CHW-S-2623-ECH

### CHW-S/H-3030

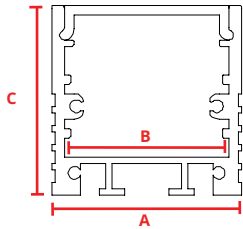

- A:** 1.18" (30.00mm)  
**B:** 1.01" (25.60mm)  
**C:** 1.18" (30.00mm)

\*Must specify for hanging or surface mount application.



**MATERIAL**  
Anodized Aluminum



**DESCRIPTION**  
Wide and deep surface mounted or hanging channel with flat lens for even blending.



**LENGTH**  
2 meter



**LENS TYPES**  
Milky CHW-SH-3030-CM

**ACCESSORIES**

**Endcap** CHW-SH-3030-EC  
**Endcap w/hole** CHW-SH-3030-ECH  
**Hanging Hardware** CHW-SH-MW  
**Bracket Straight** CHW-SH-BS  
**Bracket 90° Flat** CHW-SH-B90F  
**Bracket 90° Raised** CHW-SH-B90R  
**End Cap for FLEX AC** CHW-SH-3030-ECAC  
**Mounting Clip for FLEX AC** CHW-SH-3030-MCAC  
**VHB Tape** VHBTAPE.AC

### CHC-S-1921

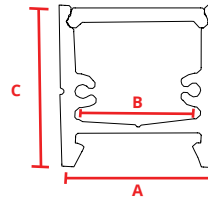

- A:** 0.76" (19.43mm)  
**B:** 0.55" (14.09mm)  
**C:** 0.84" (21.43mm)



**MATERIAL**  
Anodized Aluminum



**DESCRIPTION**  
Surface mount channel with flat lens. Mounts to ferrous and non-ferrous surfaces using magnets with no visible fasteners once mounted.



**LENGTH**  
2 meter



**LENS TYPES**  
Milky CHC-S-1921-CM

**ACCESSORIES**

**Anodized Aluminum Endcap** CHC-S-1921-EC  
**Anodized Aluminum Endcap w/hole** CHC-S-1921-ECH  
**Channel Mounted Magnet** CHC-S-1921-MA  
**Wall Mounted Magnet** CHC-S-1921-M  
**1" Mounting Plate** CHC-S-1921-B1

### CHSP-S-1618

Fits IP40 FLEX STP only

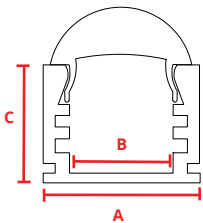

- A:** 0.63" (16.00mm)  
**B:** 0.40" (10.16mm)  
**C:** 0.49" (11.90mm)



**MATERIAL**  
Anodized Aluminum



**DESCRIPTION**  
Includes an aluminum insert that allows selection between (4) different beamspreads based on the position of the insert.



**LENGTH**  
2 meter



**LENS TYPES**  
Focusing Lens CHSP-S-1618-CFL

**ACCESSORIES**

**Endcap** CHSP-S-1618-EC  
**Endcap w/hole** CHSP-S-1618-ECH  
**Mounting Clip** CHSP-S-1618-MC

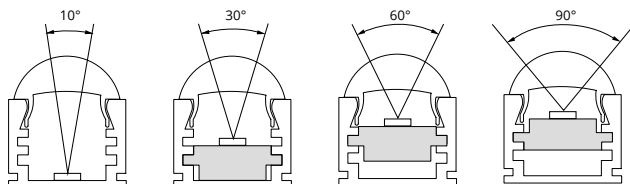

## ACCESSORIES

### LC-I2P-M

Indoor Lead Connector  
(Male)

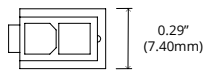
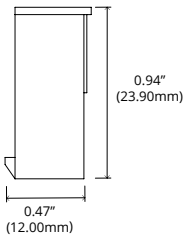
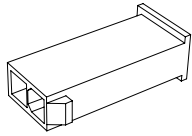

### LC-I2P-F

Indoor Lead Connector  
(Female)

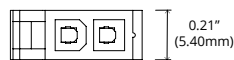
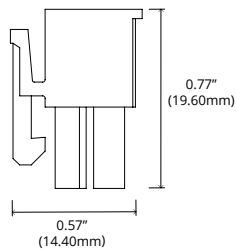
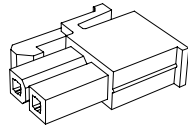

### FLEX.ZIP

Strain Relief Clip

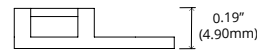
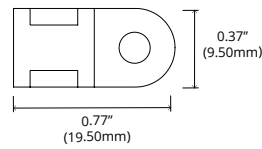
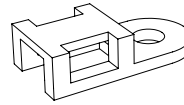

### FLEXMNT.SIL.INT

Indoor Mounting Clip

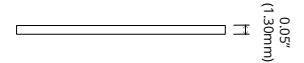
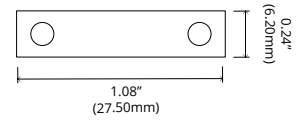
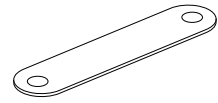

### PFC-HO-1208-SS-KIT

**1a** Configuration 1 with  
Auxiliary Housing Accessory

Flex Connect Auxiliary Housing  
Accessory

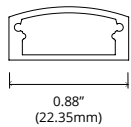
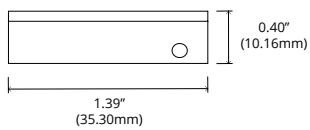
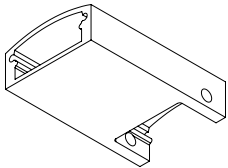

### PFC-HO-1715-SS-KIT

**1a** Configuration 1 with  
Auxiliary Housing Accessory

Flex Connect Auxiliary Housing  
Accessory

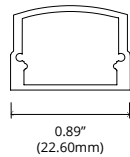
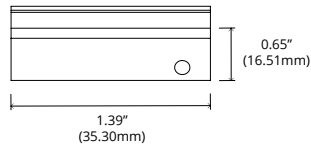
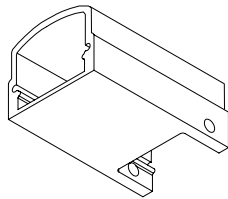

## ACCESSORIES

### FLEX STP.PFC-02.10

Field installed FLEX Connect® power feed  
- 2 Conductor for 10mm Strip

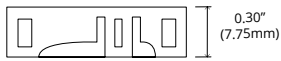
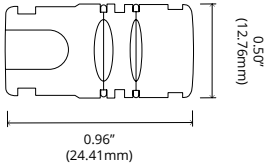

Fits in all channel **except**:

- CHS-R-1208
- CHS-R-1715
- CHS-S-1208
- CHS-S-1715
- CHS-C-1919
- CHS-C-1616
- CHC-S-1921
- CHSP-R-2970
- CHSP-S-1618
- CHSP-STEP-8142

### FLEXSTP.BSC.02.10

Field installed FLEX Connect® butt splice -  
2 Conductor for 10mm Strip

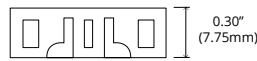
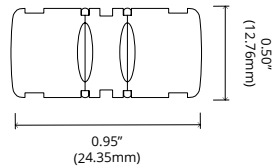

Fits in all channel **except**:

- CHS-R-1208
- CHS-R-1715
- CHS-S-1208
- CHS-S-1715
- CHS-C-1919
- CHS-C-1616
- CHC-S-1921
- CHSP-R-2970
- CHSP-S-1618
- CHSP-STEP-8142

### LO-18G-2C-W-72

6' wire lead for FLEX Connect®  
(not in-wall rated)

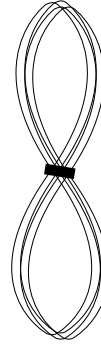

### LP-18G-2C-W-72

6' Plenum rated wire lead for  
FLEX Connect™

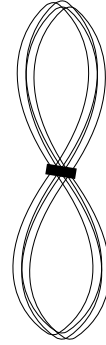

### LO-18G-2C-W-SP

1000' spool of wire for  
FLEX Connect® (not in-wall rated)

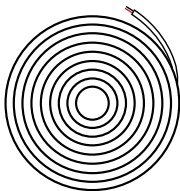

### LP-18G-2C-W-SP

500' box of Plenum rated wire for  
FLEX Connect®

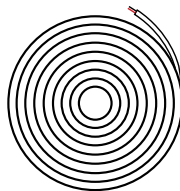



## CONFIGURATION TYPES

### 1 FLEX cut to length with FLEX Connect® Power Feeds for Field Termination, Channel uncut for field cutting

- Specify **FLEXConfig-1**
- Specify FLEX type and channel type
- FLEX factory cut to length, but not terminated
- One FLEX Connect® power feed connector and 6' lead provided per FLEX run
  - Uncut rolls of lead wire can also be provided (see page 8 for part #)
- Channel shipped uncut for field cutting.
- Specify number of butt splices (not shown - see page 8)
- IP68 not available in **FLEXConfig-1**
- JA8 2016 not available in **FLEXConfig-1**
- FLEXConfig-1** is quick ship if run lengths are provided at time of order. Take offs, if needed, will add lead time.
- The below channels are **NOT** compatible with FLEX Connect®:
  - Slim:**
    - CHS-R-1208
    - CHS-R-1715
    - CHS-S-1208
    - CHS-S-1715
    - CHS-C-1616
    - CHC-S-1921
  - Specialty:**
    - CHSP-R-2970
    - CHSP-S-1618
    - CHSP-STEP-8142

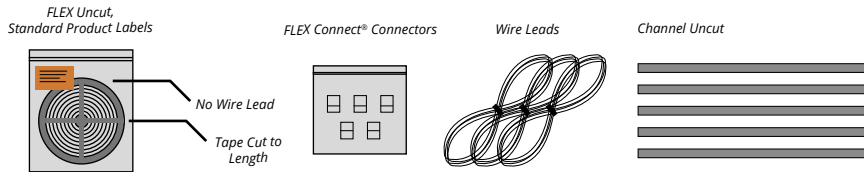

### 2 Cut To Length With Soldered Leads, Assemble On-Site<sup>1, 2, 3</sup>

- Specify **FLEXConfig-2**
- Specify FLEX type and channel type
- Specify run lengths
- IP68 only available in **FLEXConfig-2**
- If no config is specified, and run lengths are provided, **FLEXConfig-2** will be used

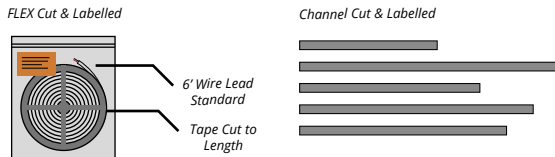

### 3 Pre-Assembled Factory Finished Fixtures<sup>1, 2</sup>

- Specify **FLEXConfig-3**
- Fully assembled fixture
- ETL stamped and listed as a fixture
- 6.50' max length
- Standard 6' power lead unless otherwise specified
- The below channels **CANNOT** be factory assembled:
  - Slim:**
    - CHS-R-1208
    - CHS-R-1715
  - Wide:**
    - CHW-R-2010
    - CHW-S-2027
    - CHW-S-7532
    - CHW-S-2623
    - CHW-S-3030
    - CHW-S-3561

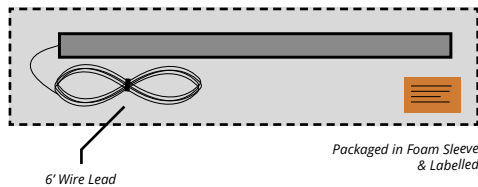

#### NOTES:

- Due to the nature of the FLEX STP product, specific lengths may not fall exactly on a cutting point. In this case, Optic Arts® will always cut to the smaller dimension unless otherwise specified.
- Unless otherwise specified, channel is cut 15mm longer than FLEX STP.
- Some on-site assembly required. See installation guides for details.

## COMPATIBLE DRIVERS

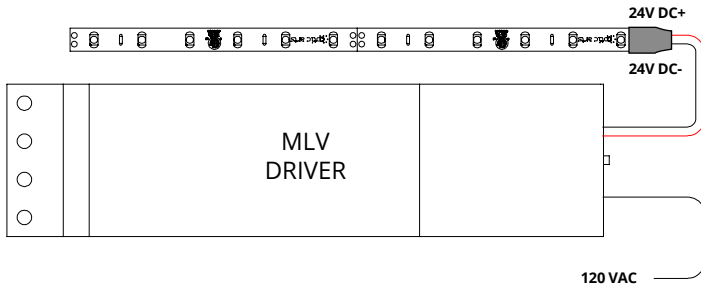

## MLV (MLV)

PART	DESCRIPTION
ML10S24VDC	10W 120VAC DIMMABLE DRIVER
ML20S24VDC	20W 120VAC DIMMABLE DRIVER
ML35S24VDC	35W 120VAC DIMMABLE DRIVER
ML35S24VDC-277	35W 277VAC DIMMABLE DRIVER
ML40S24VDC	40W 120VAC DIMMABLE DRIVER
ML50S24VDC	50W 120VAC DIMMABLE DRIVER
ML50S24VDC-277	50W 277VAC DIMMABLE DRIVER
ML60S24VDC	60W 120VAC DIMMABLE DRIVER
ML75S24VDC	75W 120VAC DIMMABLE DRIVER
ML75S24VDC-277	75W 277VAC DIMMABLE DRIVER
ML96S24VDC	96W 120VAC DIMMABLE DRIVER
ML96S24VDC-277	96W 277VAC DIMMABLE DRIVER
EM2-200S24DC	200W 120VAC DIMMABLE DRIVER, 2 96W CIRCUITS
EM3-300S24DC	300W 120VAC DIMMABLE DRIVER, 3 96W CIRCUITS
EM2-200S24DC-277	200W 120VAC DIMMABLE DRIVER, 2 96W CIRCUITS
EM3-300S24DC-277	288W 120VAC DIMMABLE DRIVER, 3 96W CIRCUITS

### DIMENSIONS

10W-50W	H 2.11"; W 7.38"; D 1.60"
60W-96W	H 3.93"; W 8.13"; D 1.59"
200-300W	H 5.69"; W 10.29"; D 3.13"

### DIMMING PERFORMANCE

MLV DRIVER Dims to 20% on most MLV dimmers

NOTE: Must be loaded between 75%-100% of rated load to maintain FLEX DC® warranty

### 120 VAC WIRING

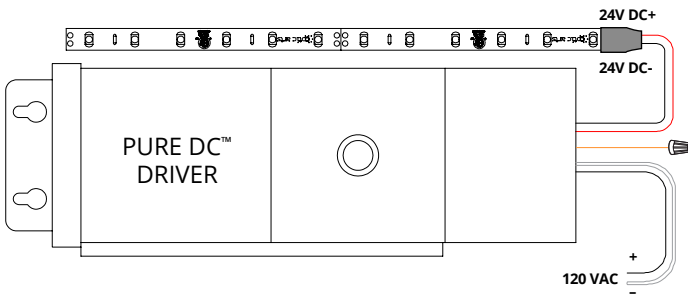

### 277 VAC WIRING

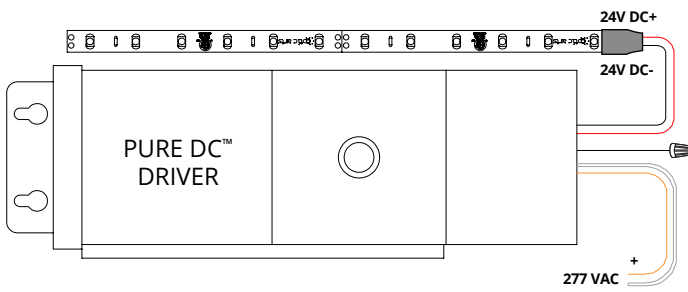

## PURE DC™ MLV (PDC)

PART	DESCRIPTION
PDC.40.24	40W 120/277VAC PURE DC™ MLV DIMMABLE DRIVER
PDC.96.24	96W 120/277VAC PURE DC™ MLV DIMMABLE DRIVER

### DIMENSIONS

40W	L 14.25"; W 3.00"; H 2.88"
96W	L 14.75"; W 4.31"; H 4.81"

### DIMMING PERFORMANCE

PURE DC™ DRIVER Dims to 0.1% on most MLV dimmers

## COMPATIBLE DRIVERS

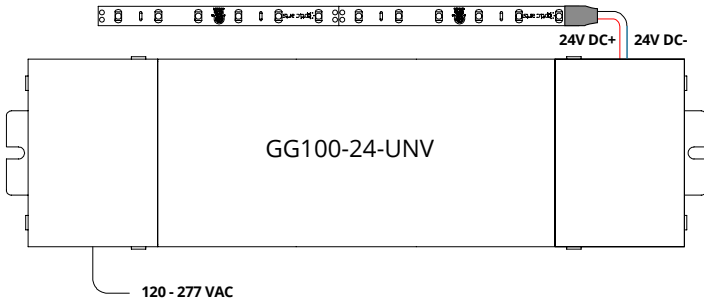

## ELECTRONIC DRIVER - NON-DIM (ND)

PART	DESCRIPTION
GG100E-24-UNV	96W 120-277VAC ELECTRONIC DRIVER
<b>DIMENSIONS</b>	
ELECTRONIC DRIVER	H 3.00"; W 11.46"; D 1.30"
<b>DIMMING PERFORMANCE</b>	
ELECTRONIC DRIVER	Non-Dim

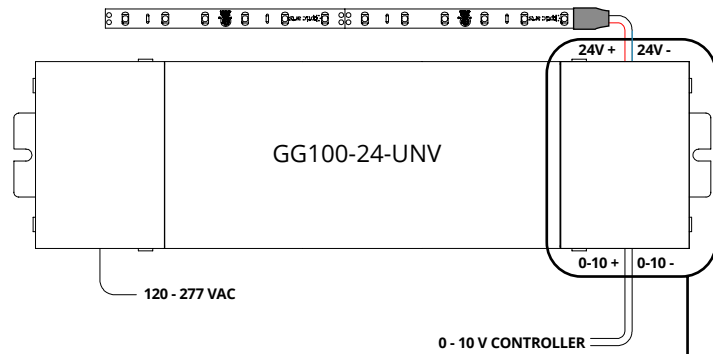

## ELECTRONIC DRIVER W/0-10V MODULE (010)

PART	DESCRIPTION
GG100E-24-UNV-010V	96W 120-277VAC ELECTRONIC DRIVER WITH 0-10V DIMMING MODULE (SINK)
<b>DIMENSIONS</b>	
ELECTRONIC DRIVER - 0-10V	H 3.00"; W 11.46"; D 1.30"
<b>DIMMING PERFORMANCE</b>	
ELECTRONIC DRIVER - 0-10V	Dims below 1% on most 0-10V dimmers

### FIELD INSTALLED IN LOW VOLTAGE WIRING COMPARTMENT

- Install DIM-010V Module in low voltage wiring compartment.
- Max number of 25 modules on one dimmer. Consult dimmer datasheet for maximum device limitation of a specific controller.

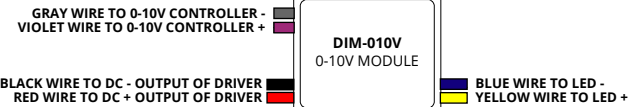

COMPATIBLE DRIVERS

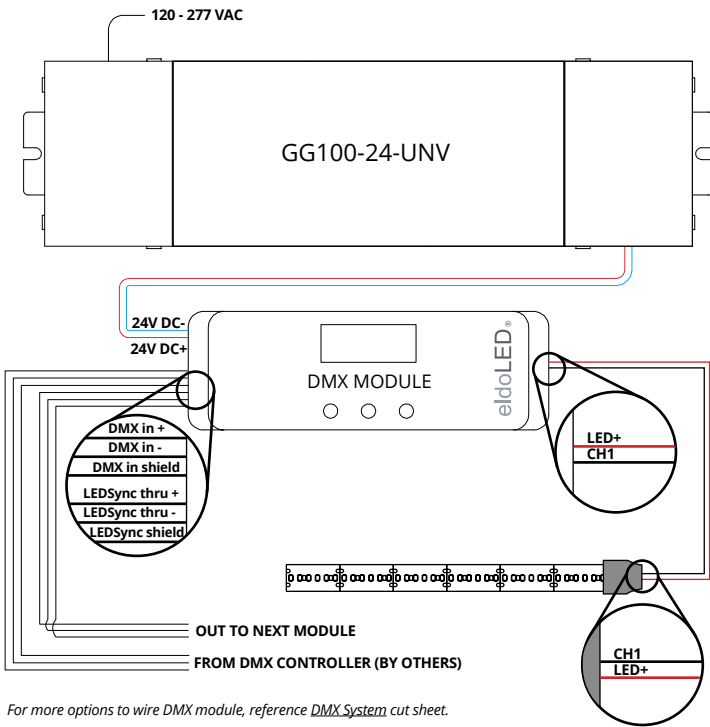

For more options to wire DMX module, reference [DMX System](#) cut sheet.

## ELECTRONIC DRIVER W/DMX MODULE (DMX)

PART	DESCRIPTION
GG100E-24-UNV-DMX	96W 120-277VAC ELECTRONIC DRIVER WITH eldoLED DMX DIMMING MODULE

### DIMENSIONS

96W	H 3.00"; W 11.46"; D 1.30"
DMX MODULE	H 1.97"; W 6.02"; D 0.91"

\*Must be installed in UL box (by others)

### DIMMING PERFORMANCE

ELECTRONIC DRIVER - DMX MODULE	Dims to 0.1% on most DMX systems
--------------------------------	----------------------------------

COMPATIBLE DRIVERS

### DIMMER WITH NEUTRAL

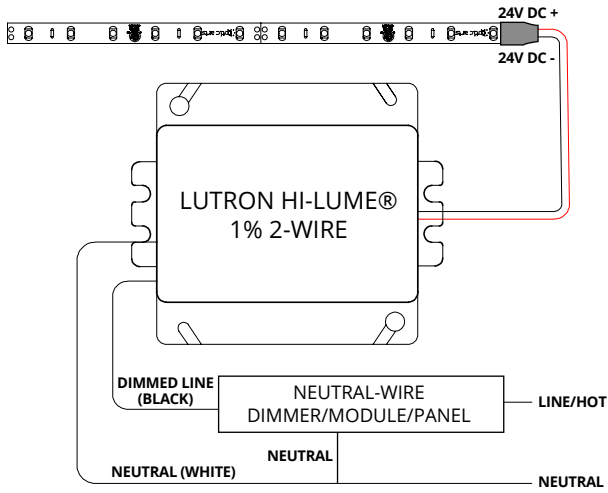

### DIMMER WITHOUT NEUTRAL

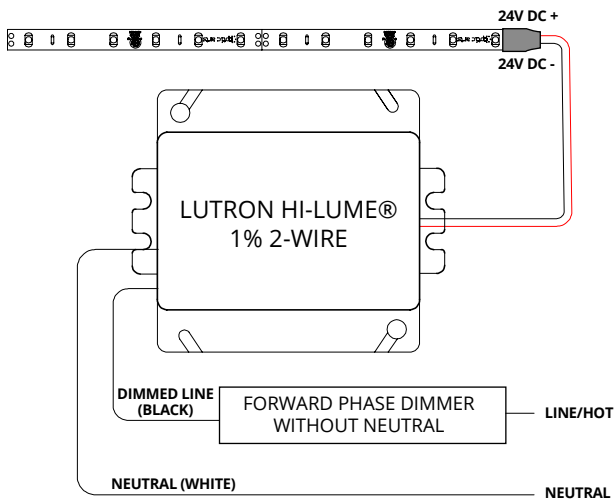

**LUTRON HI-LUME® 1% 2-WIRE:**  
2-WIRE CONTROL FORWARD PHASE



PART	DESCRIPTION
LTEA4U1UKL-CV240	5-40W, 120VAC, 2-WIRE FORWARD PHASE DRIVER
DIMENSIONS	
HI-LUME® 1% 2-WIRE	H 4.00"; W 4.89"; D 2.62"
DIMMING PERFORMANCE	
LUTRON HI-LUME® 1% 2-WIRE	Dims to 1% with compatible Lutron controls

COMPATIBLE DRIVERS

### 3-WIRE

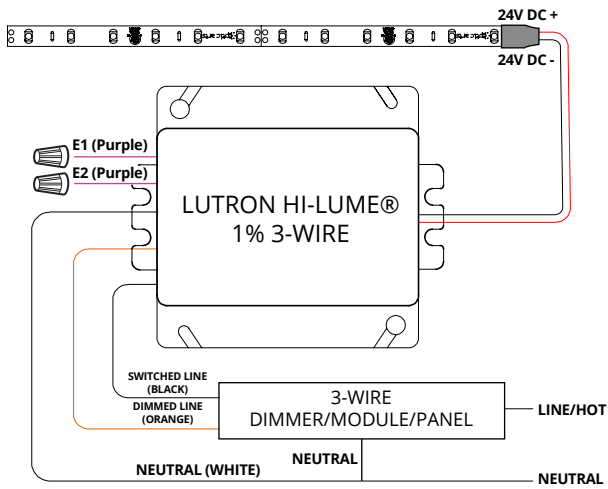

### ECOSYSTEM

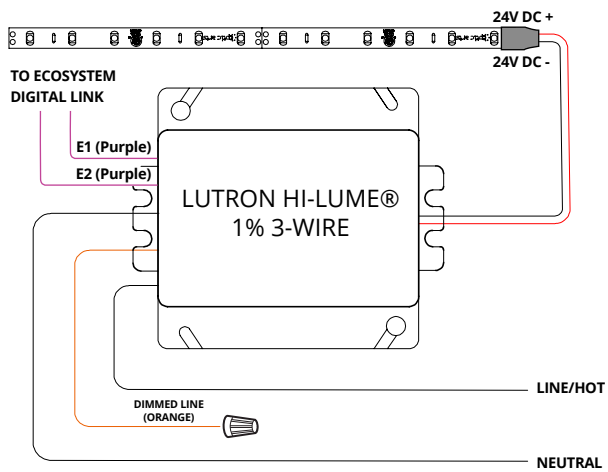

### LUTRON HI-LUME® 1%: 3-WIRE/ECOSYSTEM



PART	DESCRIPTION
L3DA4U1UKL-CV240	5-40W, 120-277VAC, 3-WIRE/ECOSYSTEM DRIVER
DIMENSIONS	
HI-LUME® 1%	H 4.00"; W 4.89"; D 2.62"
DIMMING PERFORMANCE	
LUTRON HI-LUME® 1% 3-WIRE/ECOSYSTEM	Dims to 1% with compatible Lutron controls

COMPATIBLE DRIVERS

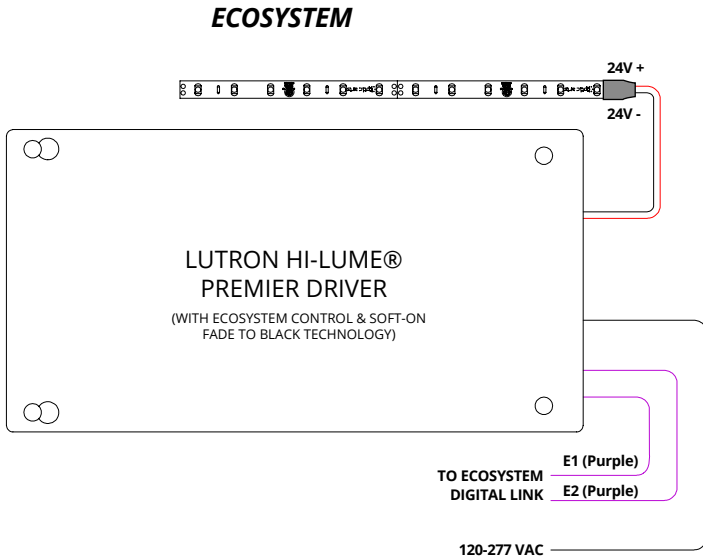
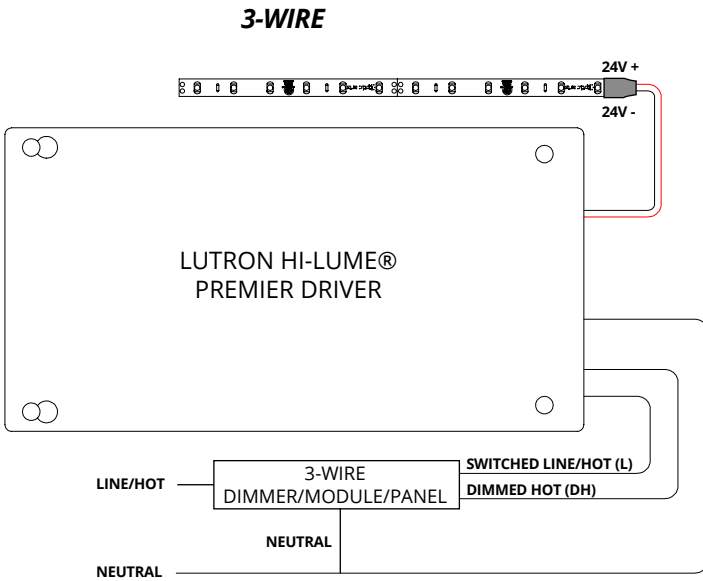

**LUTRON HI-LUME® PREMIER:**  
3-WIRE/ECOSYSTEM



PART	DESCRIPTION
L3D0-96W24V-U	2-96W, 120-277VAC, 3-WIRE/ECOSYSTEM DRIVER

DIMENSIONS	
HI-LUME® PREMIER	H 5.5"; W 10.5"; D 2.0"

DIMMING PERFORMANCE	
LUTRON HI-LUME® PREMIER	Dims to 0.1% with compatible Lutron controls

*NOTE: Lutron soft-on, fade to black technology available with Ecosystem Digital Control only.*

TM-30 - 1800K

**Rf 85.7**  
Fidelity index Rf

**Rg 86.4**  
Gammut index Rg

Hue Bin	R <sub>f</sub>	Graphic shifts (%)	
		Chroma	Hue
1	93	-2%	0%
2	87	-3%	-5%
3	77	-6%	-10%
4	80	-14%	-8%
5	86	-17%	1%
6	73	-11%	13%
7	77	-7%	12%
8	80	0%	14%
9	93	1%	3%
10	95	1%	-2%
11	87	-2%	-7%
12	85	-3%	-8%
13	82	-7%	-11%
14	83	-13%	-10%
15	87	-8%	2%
16	88	-6%	3%

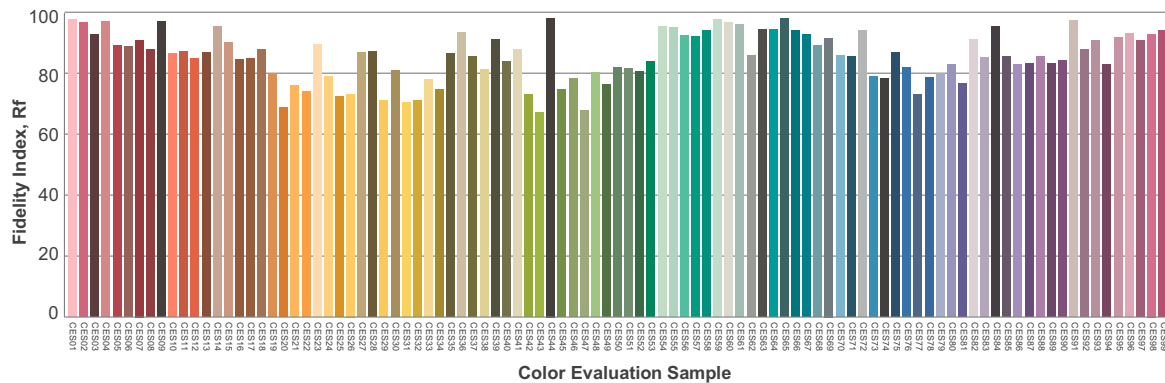
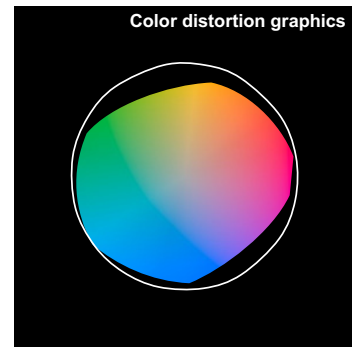
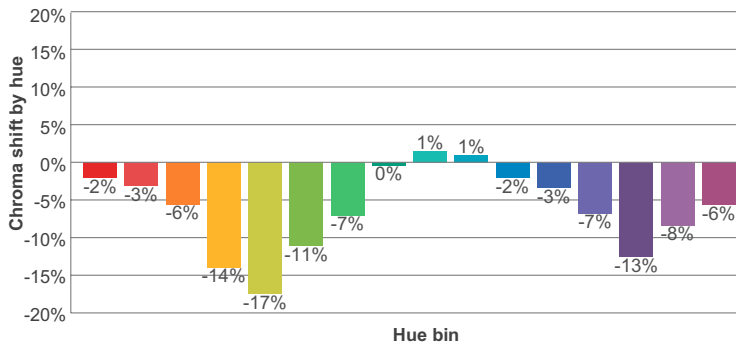
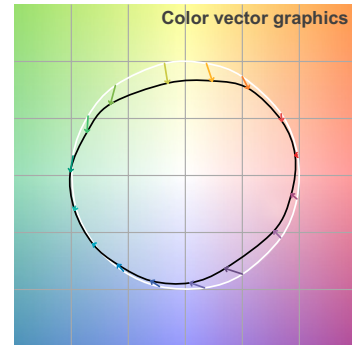
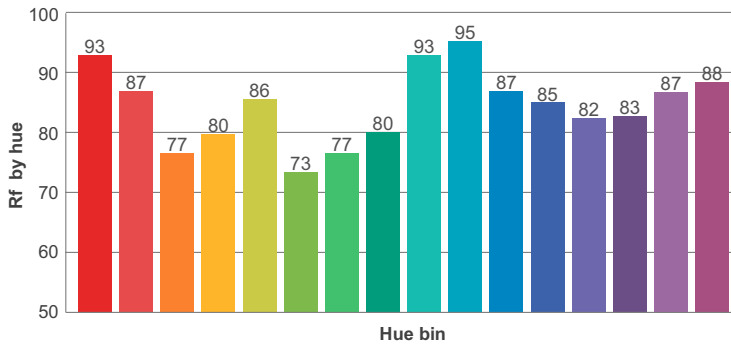
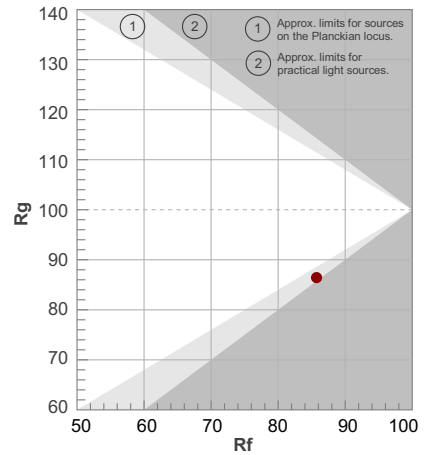



TM-30 - 2350K

**Rf 94.5**  
Fidelity index Rf

**Rg 102.9**  
Gammut index Rg

Hue Bin	R <sub>f</sub>	Graphic shifts (%)	
		Chroma	Hue
1	96	-1%	1%
2	97	0%	1%
3	94	1%	2%
4	95	-1%	-1%
5	95	0%	1%
6	94	3%	1%
7	95	1%	0%
8	97	2%	-1%
9	96	1%	2%
10	96	1%	2%
11	92	4%	3%
12	93	4%	-1%
13	91	3%	-7%
14	90	3%	-6%
15	95	0%	-2%
16	90	1%	-7%

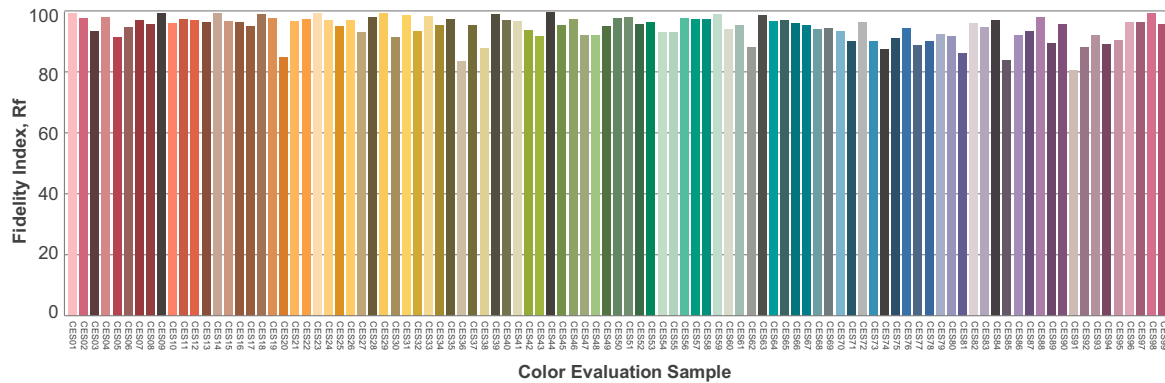
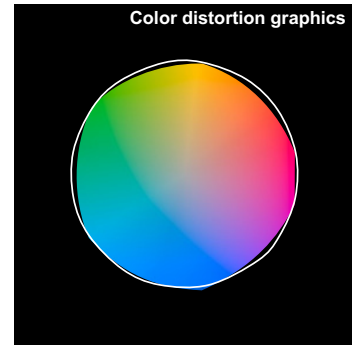
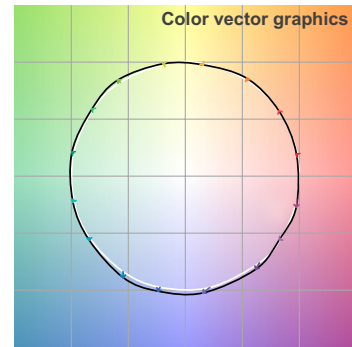
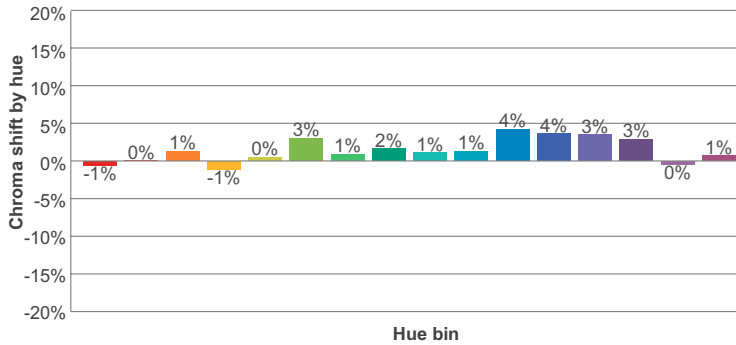
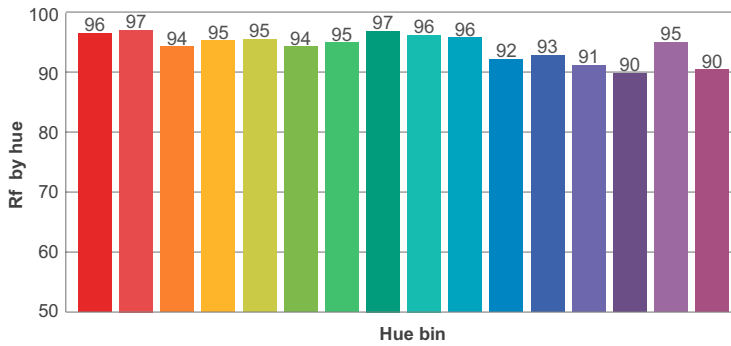
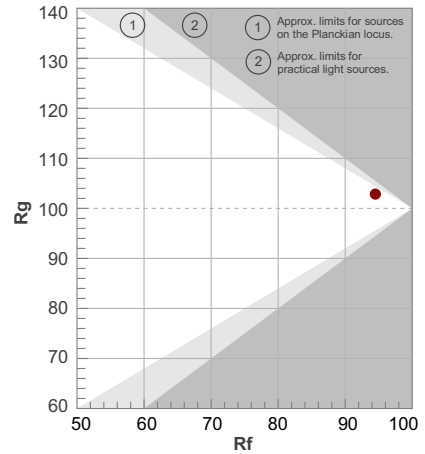

TM-30 - 2750K

**Rf 93.3**  
Fidelity index Rf

**Rg 101.2**  
Gammut index Rg

Hue Bin	R <sub>f</sub>	Graphic shifts (%)	
		Chroma	Hue
1	95	-1%	1%
2	97	0%	1%
3	95	0%	2%
4	93	-3%	-1%
5	95	-1%	1%
6	97	1%	0%
7	92	-2%	2%
8	98	0%	1%
9	93	0%	4%
10	90	1%	6%
11	89	4%	6%
12	91	5%	0%
13	94	2%	-3%
14	91	4%	-5%
15	94	-1%	-1%
16	88	1%	-8%

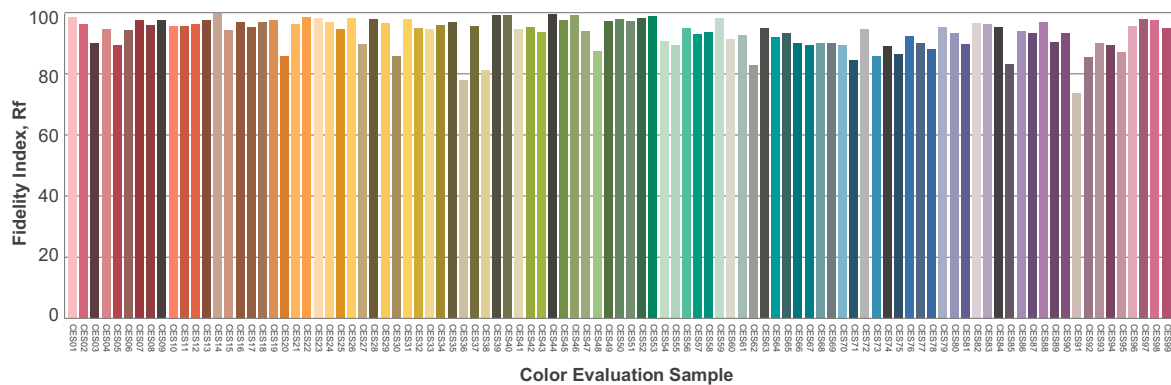
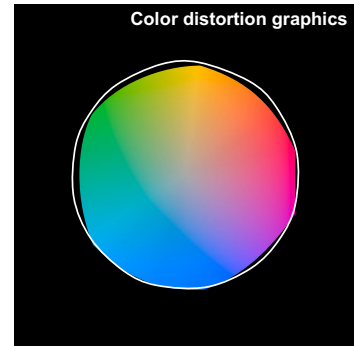
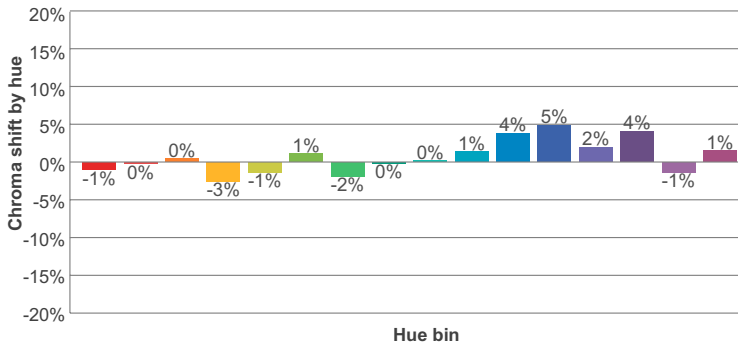
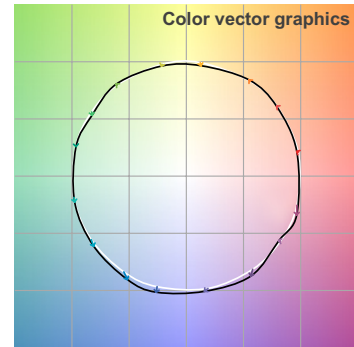
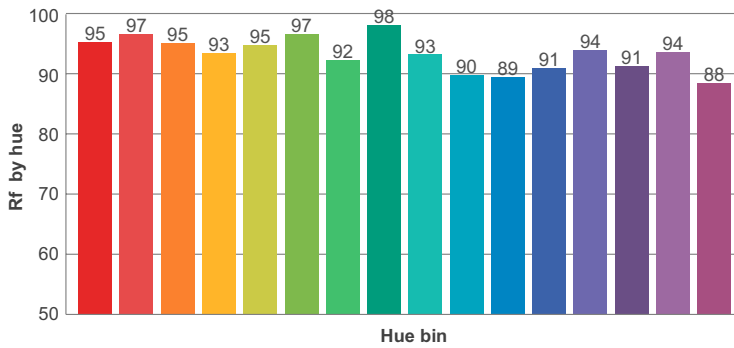
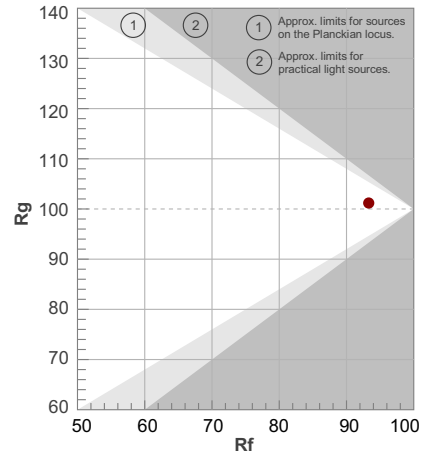

TM-30 - 2930K

**Rf 91.3**  
Fidelity index Rf

**Rg 99.5**  
Gammut index Rg

Hue Bin	R <sub>f</sub>	Graphic shifts (%)	
		Chroma	Hue
1	93	-2%	2%
2	95	0%	1%
3	95	0%	1%
4	91	-4%	-3%
5	94	-3%	0%
6	96	-1%	0%
7	89	-4%	2%
8	95	-1%	4%
9	89	0%	6%
10	86	2%	8%
11	87	5%	7%
12	90	5%	0%
13	93	1%	-5%
14	90	3%	-6%
15	91	-3%	0%
16	87	1%	-9%

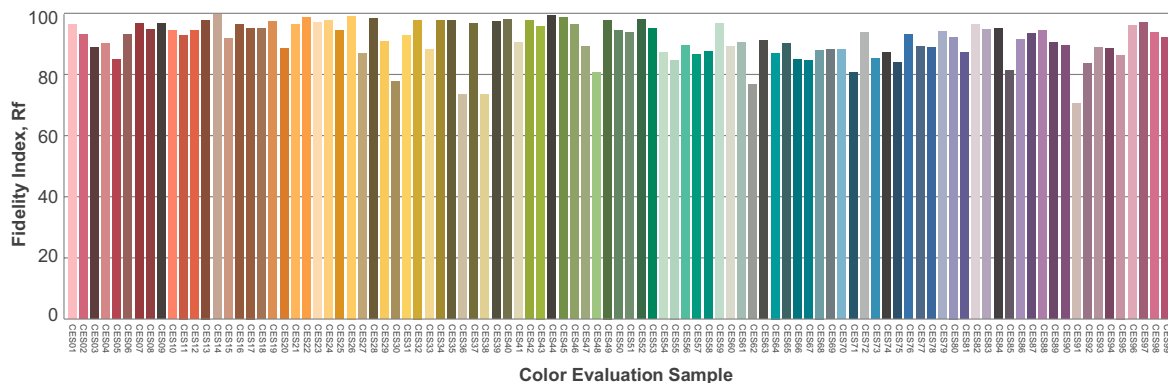
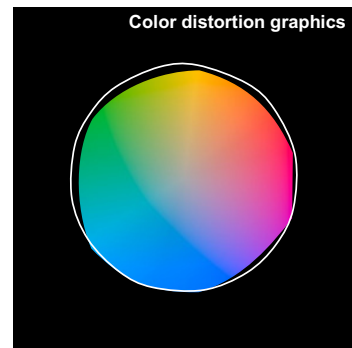
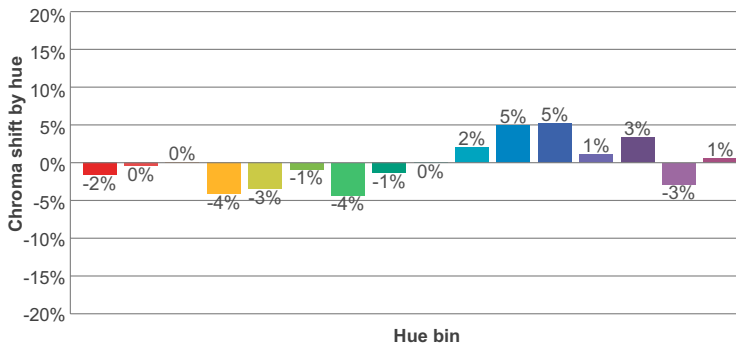
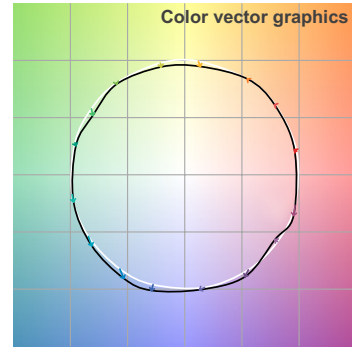
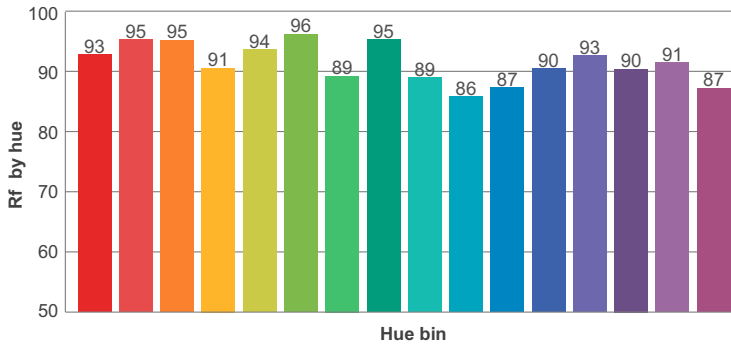
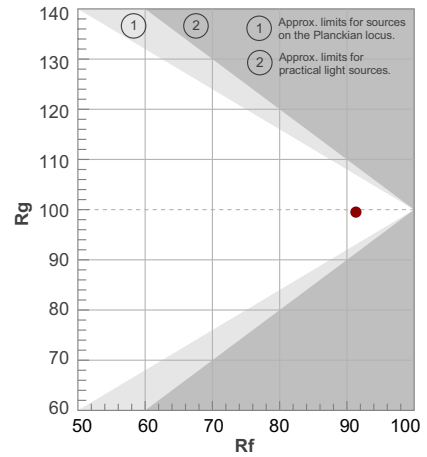

TM-30 - 3550K

**Rf 91.9**  
Fidelity index Rf

**Rg 101.0**  
Gammut index Rg

Hue Bin	R <sub>f</sub>	Graphic shifts (%)	
		Chroma	Hue
1	95	0%	1%
2	97	0%	0%
3	95	0%	1%
4	93	-2%	0%
5	91	-4%	0%
6	96	0%	1%
7	94	-3%	2%
8	95	-1%	2%
9	91	-1%	5%
10	86	0%	9%
11	85	4%	9%
12	89	4%	3%
13	96	2%	-1%
14	92	6%	-2%
15	91	2%	-2%
16	89	2%	-5%

