



FLEX DC® 30 is a high performance flexible LED fixture suitable for use in covers, under cabinets, in shelves, in-grade, and virtually anywhere a linear fixture is required.

ELECTRICAL

Input Voltage	24VDC
Dimming Options	<ul style="list-style-type: none"> • PURE DC™ • MLV • 0-10V • DMX • Lutron (2-WIRE, 3-WIRE, EcoSystem)
Power Consumption	3.0 Watts per foot
Wire Size	18AWG, 2 wire
Certification	<p>ETL - Conforms to UL Std. 2108; Certified to CSA Std. C22.2 No. 9.0.</p> <p>Closet Rated - Suitable for installation in the storage area of a clothes closet when used in Optic Arts® channel.</p>

PHYSICAL

Field Cuttable	Every 1.97"
Operating Temperature	-40° C (-40°F) to +70°C (+158°F)
Environment	<p>IP40 - Dry Location</p> <p>IP68 - Wet Location</p>
Maximum Run Length	IP40: 32', IP68: 32'
Dimensions (WxH)	<p>IP40 - 0.31" (8.0mm) x 0.12" (3.2mm)</p> <p>IP68 - 0.41" (10.4mm) x 0.18" (4.5mm)</p> <p>IP68 Endcaps - 0.50" (12.70mm) x 0.31" (7.87mm)</p>

ACCESSORIES

Mounting Clips	FLEXMNT.SIL.INT, FLEXMNT.SIL.EXT12 (pg. 7)
Channels	Optic Arts® Channel (pg. 3-6)
Connectors	LC-I2P-M, LC-I2P-F, LC-O2P-F, LC-O2P-M (pg. 7)
FLEXConfig-1 Accessories	FLEXDC.PFC.02.08, FLEXDC.BSC.02.08, LO-18G-2C-W-72, LP-18G-2C-W-72, LO-18G-2C-W-SP, LP-18G-2C-W-SP (pg. 8)

LUMEN OUTPUT

2000K (IP40 only)	174.44 lm/ft 62.44 lm/Watt
2400K	230.22 lm/ft 76.74 lm/Watt
2700K	262.59 lm/ft 87.53 lm/Watt
3000K	265.65 lm/ft 88.55 lm/Watt
3500K	276.03 lm/ft 92.01 lm/Watt
4100K	286.77 lm/ft 95.59 lm/Watt
6000K	272.94 lm/ft 90.98 lm/Watt
Amber	72.00 lm/ft 27.00 lm/Watt

Note: Stated lumen values have a tolerance of +/- 10%.

PERFORMANCE

CRI	90+
Lumen Maintenance	50,000 Hours
Binning Tolerance	+/- 100K
Warranty	5 years

PART NUMBER BUILDER

SERIES	+	IP RATING	+	COLOR	+	VOLTAGE	+	WATTAGE	+	CONFIGURATION	+	LENGTH		
FLEXDC		<p>40 = IP40 - Dry Location</p> <p>68 = IP68 - Wet Location</p>		<p>20 = 2000K (IP40 only)</p> <p>24 = 2400K</p> <p>27 = 2700K</p> <p>30 = 3000K</p> <p>35 = 3500K</p> <p>41 = 4100K</p>		<p>60 = 6000K</p> <p>R = Red</p> <p>G = Green</p> <p>B = Blue</p> <p>A = Amber</p>		<p>24 = 24 VDC</p>		<p>30 = 3.0W</p>		<p>FLC1 = FLEX Config 1</p> <p>FLC2 = FLEX Config 2</p> <p>FLC3 = FLEX Config 3</p>		<p>XX = Custom Length</p>



DIMENSIONS

INDOOR FLEX DC® 30

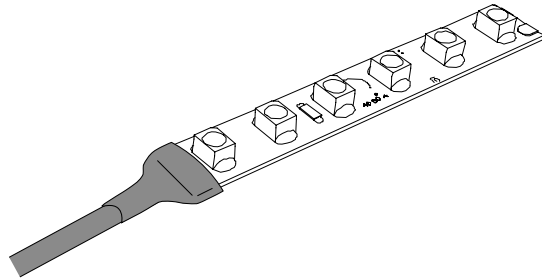
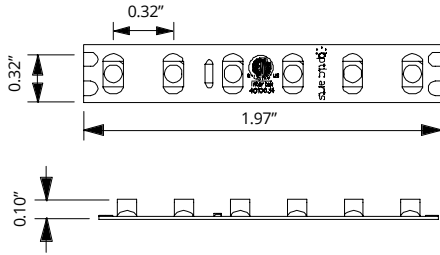

INDOOR DIMENSIONS

Width	0.32" (8.00mm)
Height	0.10" (2.52mm)
Cuttable Segment Length	1.97" (50.00mm)
Pitch Length	0.32" (8.00mm)
Max Run Length	32.00' (9753.60mm)

OUTDOOR FLEX DC® 30

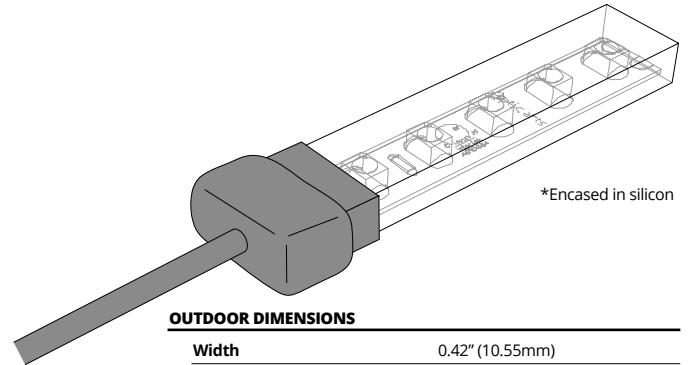
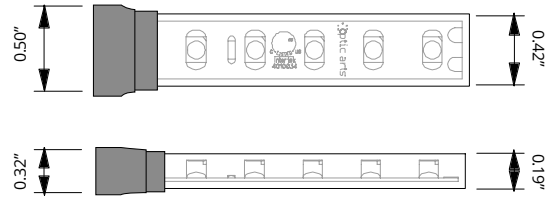

OUTDOOR DIMENSIONS

Width	0.42" (10.55mm)
Height	0.19" (4.88mm)
Width (Endcap)	0.50" (12.70mm)
Height (Endcap)	0.32" (7.94mm)
Max Run Length	32.00' (6096.00mm)

INDOOR FLEX DC® 30

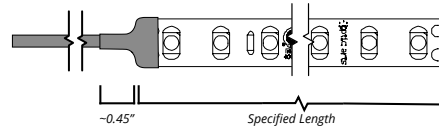

OUTDOOR FLEX DC® 30

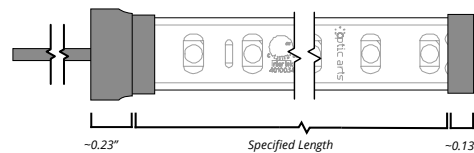

KEY

CHANNEL PART NUMBER BREAKDOWN:

CHS	+	R	+	1208
SERIES		APPLICATION		DIMENSIONS
CHS = Slim Channel CHW = Wide Channel		S = Surface Mount R = Recessed Mount C = Corner Mount H = Hanging Mount		XXXX = W x H (mm)

CHS-R-1208

• Click on channel titles below to access complete channel cut sheets

DIFFUSION LEVEL:

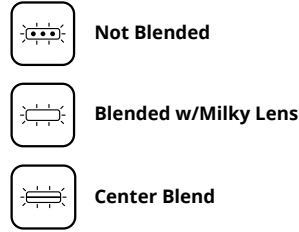

CONFIGURATION:

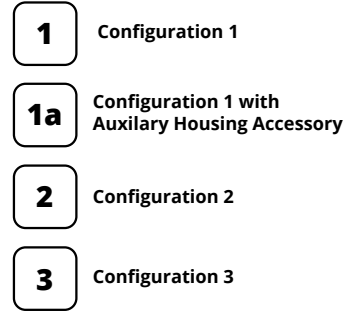

CHS-R-1208

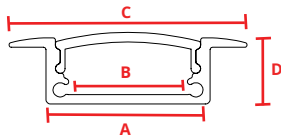

- A:** 0.68" (17.25mm)
- B:** 0.50" (12.59mm)
- C:** 0.98" (25.00mm)
- D:** 0.34" (8.60mm)



MATERIAL	Anodized Aluminum						
DESCRIPTION	Slim and shallow recessed channel.						
LENGTH	2 meter						
LENS TYPES	<table border="0"> <tr><td>Clear</td><td>CHS-12mm-CC</td></tr> <tr><td>Frosted</td><td>CHS-12mm-CF</td></tr> <tr><td>Milky</td><td>CHS-12mm-CM</td></tr> </table>	Clear	CHS-12mm-CC	Frosted	CHS-12mm-CF	Milky	CHS-12mm-CM
Clear	CHS-12mm-CC						
Frosted	CHS-12mm-CF						
Milky	CHS-12mm-CM						
ACCESSORIES	<table border="0"> <tr><td>Endcap</td><td>CHS-R-1208-EC</td></tr> <tr><td>Endcap w/hole</td><td>CHS-R-1208-ECH</td></tr> </table>	Endcap	CHS-R-1208-EC	Endcap w/hole	CHS-R-1208-ECH		
Endcap	CHS-R-1208-EC						
Endcap w/hole	CHS-R-1208-ECH						

CHS-S-1208

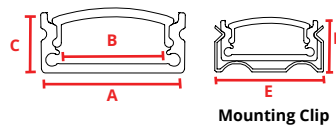

- A:** 0.68" (17.25mm)
- B:** 0.50" (12.59mm)
- C:** 0.34" (8.60mm)
- D:** 0.40" (12.70mm)
- E:** 0.78" (19.90mm)



MATERIAL	Anodized Aluminum								
DESCRIPTION	Slim and shallow surface mounted channel.								
LENGTH	2 meter								
LENS TYPES	<table border="0"> <tr><td>Clear</td><td>CHS-12mm-CC</td></tr> <tr><td>Frosted</td><td>CHS-12mm-CF</td></tr> <tr><td>Milky</td><td>CHS-12mm-CM</td></tr> <tr><td>Grazer</td><td>CHS-12mm-CG</td></tr> </table>	Clear	CHS-12mm-CC	Frosted	CHS-12mm-CF	Milky	CHS-12mm-CM	Grazer	CHS-12mm-CG
Clear	CHS-12mm-CC								
Frosted	CHS-12mm-CF								
Milky	CHS-12mm-CM								
Grazer	CHS-12mm-CG								
ACCESSORIES	<table border="0"> <tr><td>Endcap</td><td>CHS-S-1208-EC</td></tr> <tr><td>Endcap w/hole</td><td>CHS-S-1208-ECH</td></tr> <tr><td>Mounting Clip</td><td>CHS-S-1208-MC</td></tr> <tr><td>Rotating Mounting Clip</td><td>CHS-S-1208-MCR</td></tr> </table>	Endcap	CHS-S-1208-EC	Endcap w/hole	CHS-S-1208-ECH	Mounting Clip	CHS-S-1208-MC	Rotating Mounting Clip	CHS-S-1208-MCR
Endcap	CHS-S-1208-EC								
Endcap w/hole	CHS-S-1208-ECH								
Mounting Clip	CHS-S-1208-MC								
Rotating Mounting Clip	CHS-S-1208-MCR								

CHS-C-1919

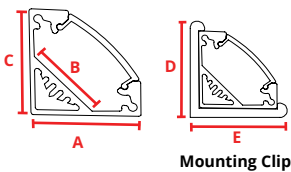

- A:** 0.73" (18.50mm)
- B:** 0.48" (12.20mm)
- C:** 0.73" (18.50mm)
- D:** 0.82" (20.82mm)
- E:** 0.82" (20.82mm)



MATERIAL	Anodized Aluminum						
DESCRIPTION	Slim corner mount channel.						
LENGTH	2 meter						
LENS TYPES	<table border="0"> <tr><td>Clear</td><td>CHS-12mm-CC</td></tr> <tr><td>Frosted</td><td>CHS-12mm-CF</td></tr> <tr><td>Milky</td><td>CHS-12mm-CM</td></tr> </table>	Clear	CHS-12mm-CC	Frosted	CHS-12mm-CF	Milky	CHS-12mm-CM
Clear	CHS-12mm-CC						
Frosted	CHS-12mm-CF						
Milky	CHS-12mm-CM						
ACCESSORIES	<table border="0"> <tr><td>Endcap</td><td>CHS-C-1919-EC</td></tr> <tr><td>Endcap w/hole</td><td>CHS-C-1919-ECH</td></tr> <tr><td>Mounting Clip</td><td>CHS-C-1919-MC</td></tr> </table>	Endcap	CHS-C-1919-EC	Endcap w/hole	CHS-C-1919-ECH	Mounting Clip	CHS-C-1919-MC
Endcap	CHS-C-1919-EC						
Endcap w/hole	CHS-C-1919-ECH						
Mounting Clip	CHS-C-1919-MC						

CHS-R-1715

*Blends with IP20/40
** No Blend with IP65/67/68

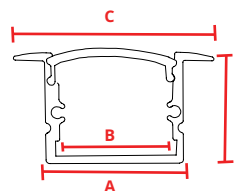

- A:** 0.68" (17.25mm)
- B:** 0.48" (12.30mm)
- C:** 0.98" (25.00mm)
- D:** 0.59" (15.05mm)



MATERIAL	Anodized Aluminum								
DESCRIPTION	Slim and deep recessed channel. Eliminates visible LED nodes when used with FLEXDC 3.0 and milky lens.								
LENGTH	2 meter								
LENS TYPES	<table border="0"> <tr><td>Clear</td><td>CHS-12mm-CC</td></tr> <tr><td>Frosted</td><td>CHS-12mm-CF</td></tr> <tr><td>Milky</td><td>CHS-12mm-CM</td></tr> <tr><td>Grazer</td><td>CHS-12mm-CG</td></tr> </table>	Clear	CHS-12mm-CC	Frosted	CHS-12mm-CF	Milky	CHS-12mm-CM	Grazer	CHS-12mm-CG
Clear	CHS-12mm-CC								
Frosted	CHS-12mm-CF								
Milky	CHS-12mm-CM								
Grazer	CHS-12mm-CG								
ACCESSORIES	<table border="0"> <tr><td>Endcap</td><td>CHS-R-1715-EC</td></tr> <tr><td>Endcap w/hole</td><td>CHS-R-1715-ECH</td></tr> </table>	Endcap	CHS-R-1715-EC	Endcap w/hole	CHS-R-1715-ECH				
Endcap	CHS-R-1715-EC								
Endcap w/hole	CHS-R-1715-ECH								

MOUNTING OPTIONS - COMPATIBLE CHANNELS

- Not Blended
 Blended w/Milky Lens
 1 Configuration 1
 1a Configuration 1 with Auxiliary Housing Accessory
 2 Configuration 2
 3 Configuration 3

CHS-S-1715

*Blends with IP20/40
 ** No Blend with IP65/67/68

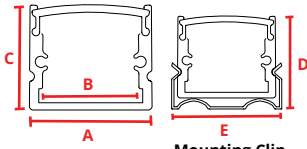

Mounting Clip

- A:** 0.68" (17.25mm)
- B:** 0.48" (12.30mm)
- C:** 0.59" (15.05mm)
- D:** 0.66" (16.76mm)
- E:** 0.78" (19.90mm)

	MATERIAL	Anodized Aluminum
	DESCRIPTION	Slim and deep surface mounted channel. Eliminates visible LED nodes when used with FLEXDC 3.0 and milky lens.
1a	LENGTH	2 meter
2	LENS TYPES	Clear CHS-12mm-CC Frosted CHS-12mm-CF Milky CHS-12mm-CM Grazer CHS-12mm-CG
3	ACCESSORIES	Endcap CHS-S-1715-EC Endcap w/hole CHS-S-1715-ECH Mounting Clip CHS-S-1715-MC Rotating Mounting Clip CHS-S-1208-MCR

CHS-C-1616

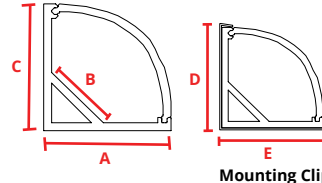

Mounting Clip

- A:** 0.63" (16.00mm)
- B:** 0.39" (10.00mm)
- C:** 0.63" (16.00mm)
- D:** 0.70" (17.78mm)
- E:** 0.70" (17.78mm)

	MATERIAL	Anodized Aluminum
	DESCRIPTION	Slim corner mount channel with rounded lens.
2	LENGTH	2 meter
3	LENS TYPES	Frosted CHS-C-1616-CF Milky CHS-C-1616-CM
	ACCESSORIES	Endcap CHS-C-1616-EC Endcap w/hole CHS-C-1616-ECH Mounting Clip CHS-C-1616-MC

CHS-S-1922S

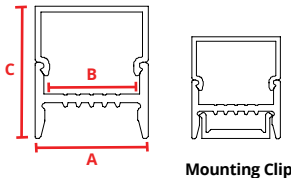

Mounting Clip

- A:** 0.77" (19.50mm)
- B:** 0.65" (16.50mm)
- C:** 0.86" (21.80mm)

	MATERIAL	Anodized Aluminum
	DESCRIPTION	Slim surface mounted channel with square wrap around lens. Mounting clip is fully concealed within fixture base.
1	LENGTH	2 meter
3	LENS TYPES	Milky CHW-S-1922S-CM
	ACCESSORIES	Endcap CHS-S-1922S-EC Endcap w/hole CHS-S-1922S-ECH Mounting Clip CHS-S-1922S-MC

CHS-S-1922R

*Blends with IP20/40
 ** No Blend with IP65/67/68

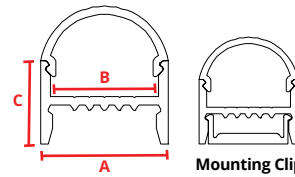

Mounting Clip

- A:** 0.77" (19.50mm)
- B:** 0.65" (16.50mm)
- C:** 0.86" (21.80mm)

	MATERIAL	Anodized Aluminum
	DESCRIPTION	Slim surface mounted channel with rounded wrap around lens. Mounting clip is fully concealed within fixture base.
1	LENGTH	2 meter
2	LENS TYPES	Milky CHW-S-1922R-CM
3	ACCESSORIES	Endcap CHS-S-1922R-EC Endcap w/hole CHS-S-1922R-ECH Mounting Clip CHS-S-1922R-MC

CHW-S-2010

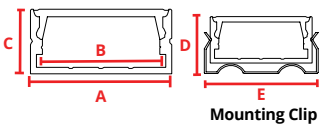

Mounting Clip

- A:** 0.93" (23.50mm)
- B:** 0.78" (20.00mm)
- C:** 0.39" (10.00mm)
- D:** 0.48" (12.19mm)
- E:** 1.02" (25.80mm)

	MATERIAL	Anodized Aluminum
	DESCRIPTION	Low profile surface mounted channel.
1	LENGTH	2 meter
2	LENS TYPES	Clear CHW-S-2010-CC Frosted CHW-S-2010-CF Milky CHW-S-2010-CM
3	ACCESSORIES	Endcap CHW-S-2010-EC Endcap w/hole CHW-S-2010-ECH Mounting Clip CHW-S-2010-MC Rotating Mounting Clip CHW-S-2010-MCR

CHW-R-2010

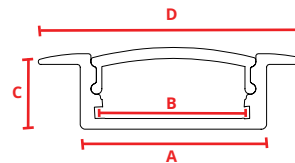

- A:** 0.93" (23.50mm)
- B:** 0.78" (20.00mm)
- C:** 0.39" (10.00mm)
- D:** 1.19" (30.24mm)

	MATERIAL	Anodized Aluminum
	DESCRIPTION	Recessed wide-profile channel.
1	LENGTH	2 meter
2	LENS TYPES	Clear CHW-R-2010-CC Frosted CHW-R-2010-CF Milky CHW-R-2010-CM
	ACCESSORIES	Endcap CHW-R-2010-EC Endcap w/hole CHW-R-2010-ECH

MOUNTING OPTIONS - COMPATIBLE CHANNELS

- Not Blended
 Blended w/Milky Lens
 1 Configuration 1
 1a Configuration 1 with Auxiliary Housing Accessory
 2 Configuration 2
 3 Configuration 3

CHW-C-3030

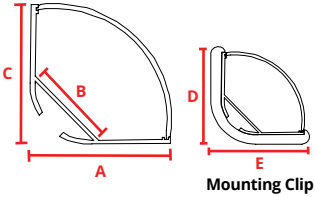

- A:** 1.18" (30.00mm)
B: 0.78" (20.20mm)
C: 1.18" (30.00mm)
D: 1.29" (32.77mm)
E: 1.29" (32.77mm)



MATERIAL

Anodized Aluminum



DESCRIPTION

45 degree channel with rounded lens.



LENGTH

2 meter



LENS TYPES

Clear	CHW-C-3030-CC
Frosted	CHW-C-3030-CF
Milky	CHW-C-3030-CM

ACCESSORIES

Endcap	CHW-C-3030-EC
Endcap w/hole	CHW-C-3030-ECH
Mounting Clip	CHW-C-3030-MC

CHW-C-3030S

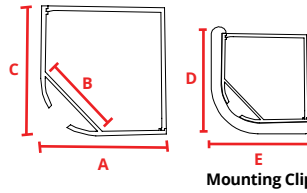

- A:** 1.18" (30.00mm)
B: 0.78" (20.20mm)
C: 1.18" (30.00mm)
D: 1.29" (32.77mm)
E: 1.29" (32.77mm)



MATERIAL

Anodized Aluminum



DESCRIPTION

45 degree channel with square lens.



LENGTH

2 meter



LENS TYPES

Clear	CHW-C-3030S-CC
Frosted	CHW-C-3030S-CF
Milky	CHW-C-3030S-CM

ACCESSORIES

Endcap	CHW-C-3030S-EC
Endcap w/hole	CHW-C-3030S-ECH
Mounting Clip	CHW-C-3030S-MC

CHW-S/H-3535

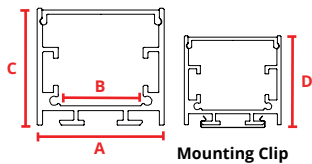

- A:** 1.39" (35.25mm)
B: 0.96" (24.50mm)
C: 1.39" (35.25mm)
D: 1.54" (39.00mm)

**Must specify for hanging or surface mount application.*



MATERIAL

Anodized Aluminum



Wide and deep surface mounted or hanging channel. Eliminates visible LED nodes for most FLEXDC products when used with a milky lens.



LENGTH

2 meter



LENS TYPES

Frosted	CHW-35mm-CF
Milky	CHW-35mm-CM

ACCESSORIES

Endcap	CHW-S-3535-EC
Endcap w/hole	CHW-S-3535-ECH
Mounting Clip	CHW-S-3535-MC
Hanging Hardware	CHW-SH-3535-MW
Bracket Straight	CHW-S-XX35-BS
Bracket 90° Flat	CHW-S-XX35-B90F
Bracket 90° Raised	CHW-S-XX35-B90R
End Cap for FLEX AC	CHW-S-3535-ECAC
Mounting Clip for FLEX AC	CHW-S-3535-MCAC
VHB Tape	VHBTAPE-AC

CHW-R-4435

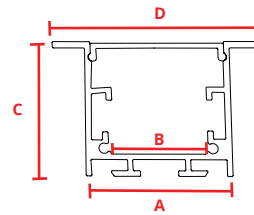

- A:** 1.39" (35.25mm)
B: 0.96" (24.50mm)
C: 1.39" (35.25mm)
D: 2.00" (51.04mm)



MATERIAL

Anodized Aluminum



Wide and deep recessed channel. Eliminates visible LED nodes for most FLEXDC products when used with a milky lens. Can be securely and conveniently mounted with CHW-R-4435-SC spring clip.



LENGTH

2 meter



LENS TYPES

Frosted	CHW-35mm-CF
Milky	CHW-35mm-CM

ACCESSORIES

Endcap	CHW-R-4435-EC
Endcap w/hole	CHW-R-4435-ECH
Mounting Clip	CHW-R-4435-SC
Bracket Straight	CHW-S-XX35-BS
Bracket 90° Flat	CHW-S-XX35-B90F
Bracket 90° Raised	CHW-S-XX35-B90R
End Cap for FLEX AC	CHW-R-4435-ECAC
Mounting Clip for FLEX AC	CHW-R-4435-MCAC
VHB Tape	VHBTAPE-AC

CHW-S/H-2027

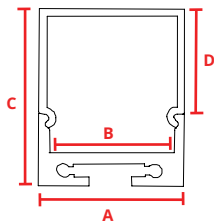

- A:** 0.79" (20.30mm)
B: 0.66" (16.70mm)
C: 1.06" (27.00mm)
D: 0.76" (19.50mm)

**Must specify for hanging or surface mount application.*



MATERIAL

Anodized Aluminum



Small surfaced mounted or hanging channel with wrap around lens.



LENGTH

2 meter



LENS TYPES

Clear	CHW-SH-2027-CC
Frosted	CHW-SH-2027-CF
Milky	CHW-SH-2027-CM

ACCESSORIES

Endcap	CHW-SH-2027-EC
End Cap w/hole	CHW-SH-2027-ECH
Hanging Hardware	CHW-SH-MW
Bracket Straight	CHW-SH-BS
Bracket 90° Flat	CHW-SH-B90F
Bracket 90° Raised	CHW-SH-B90R

CHW-S/H-3561

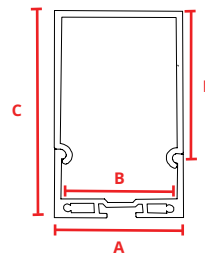

- A:** 1.38" (35.00mm)
B: 1.24" (31.40mm)
C: 2.43" (61.70mm)
D: 1.57" (39.90mm)

**Must specify for hanging or surface mount application.*



MATERIAL

Anodized Aluminum



Large surface mounted or hanging channel with wrap around lens.



LENGTH

2 meter



LENS TYPES

Milky	CHW-SH-3561-CM
-------	----------------

ACCESSORIES

Endcap	CHW-SH-3561-EC
End Cap w/hole	CHW-SH-3561-ECH
Hanging Hardware	CHW-SH-MW
Bracket Straight	CHW-SH-BS
Bracket 90° Flat	CHW-SH-B90F
Bracket 90° Raised	CHW-SH-B90R

MOUNTING OPTIONS - COMPATIBLE CHANNELS

- Not Blended
 Blended w/Milky Lens
 1 Configuration 1
 1a Configuration 1 with Auxiliary Housing Accessory
 2 Configuration 2
 3 Configuration 3

CHW-S/H-7532

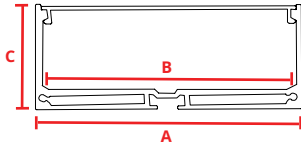

A: 2.95" (75.00mm)
B: 2.52" (64.00mm)
C: 1.26" (32.00mm)

*Must specify for hanging or surface mount application.



MATERIAL
Anodized Aluminum



DESCRIPTION
Wide surface mounted or hanging channel with flat lens.



LENGTH
2 meter



LENS TYPES
Frosted CHW-SH-7532-CF

ACCESSORIES

Endcap CHW-SH-7532-EC
Endcap w/hole CHW-SH-7532-ECH
Hanging Hardware CHW-SH-MW
Bracket Straight CHW-SH-BS
Bracket 90° Flat CHW-SH-B90F
Bracket 90° Raised CHW-SH-B90R

CHW-S-2623

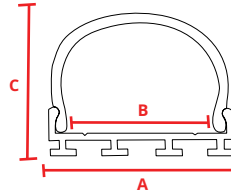

A: 1.03" (26.20mm)
B: 0.80" (20.35mm)
C: 0.89" (22.76mm)



MATERIAL
Anodized Aluminum



DESCRIPTION
Surface mounted channel with wrap around lens.



LENGTH
2 meter



LENS TYPES
Milky CHW-S-2623-CM

ACCESSORIES

Endcap CHW-S-2623-EC
Endcap w/hole CHW-S-2623-ECH

CHW-S/H-3030

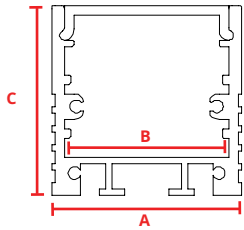

A: 1.18" (30.00mm)
B: 1.01" (25.60mm)
C: 1.18" (30.00mm)

*Must specify for hanging or surface mount application.



MATERIAL
Anodized Aluminum



DESCRIPTION
Wide and deep surface mounted or hanging channel with flat lens for even blending.



LENGTH
2 meter



LENS TYPES
Milky CHW-SH-3030-CM

ACCESSORIES

Endcap CHW-SH-3030-EC
Endcap w/hole CHW-SH-3030-ECH
Hanging Hardware CHW-SH-MW
Bracket Straight CHW-SH-BS
Bracket 90° Flat CHW-SH-B90F
Bracket 90° Raised CHW-SH-B90R
End Cap for FLEX AC CHW-SH-3030-ECAC
Mounting Clip for FLEX AC CHW-SH-3030-MCAC
VHB Tape VHBTAPE-AC

CHC-S-1921

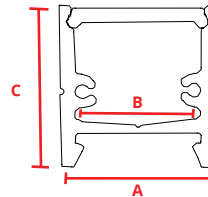

A: 0.76" (19.43mm)
B: 0.55" (14.09mm)
C: 0.84" (21.43mm)



MATERIAL
Anodized Aluminum



DESCRIPTION
Surface mount channel with flat lens. Mounts to ferrous and non-ferrous surfaces using magnets with no visible fasteners once mounted.



LENGTH
2 meter



LENS TYPES
Milky CHC-S-1921-CM

ACCESSORIES

Anodized Aluminum Endcap CHC-S-1921-EC
Anodized Aluminum Endcap w/hole CHC-S-1921-ECH
Channel Mounted Magnet CHC-S-1921-MA
Wall Mounted Magnet CHC-S-1921-M
1" Mounting Plate CHC-S-1921-B1

CHSP-S-1618

Fits IP40 FLEX DC®

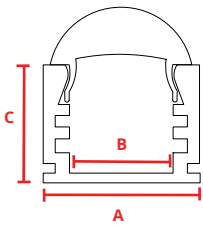

A: 0.63" (16.00mm)
B: 0.40" (10.16mm)
C: 0.49" (11.90mm)



MATERIAL
Anodized Aluminum



DESCRIPTION
Includes an aluminum insert that allows selection between (4) different beamsreads based on the position of the insert.



LENGTH
2 meter



LENS TYPES
Focusing Lens CHSP-S-1618-CFL

ACCESSORIES

Endcap CHSP-S-1618-EC
Endcap w/hole CHSP-S-1618-ECH
Mounting Clip CHSP-S-1618-MC

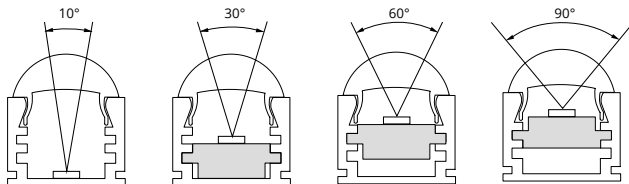

ACCESSORIES

LC-I2P-M

Indoor Lead Connector
(Male)

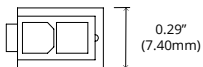
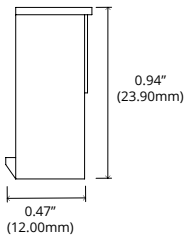
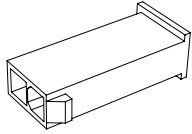

LC-I2P-F

Indoor Lead Connector
(Female)

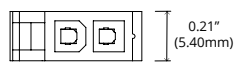
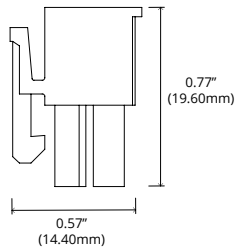
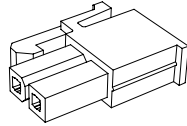

LC-O2P-F

Outdoor Lead Connector
(Female)

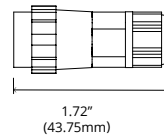
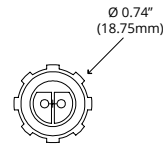
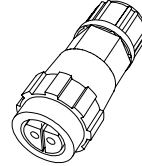

LC-O2P-M

Outdoor Lead Connector
(Male)

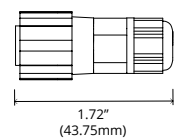
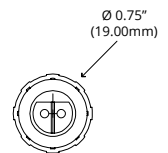
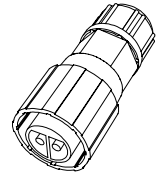

FLEX.ZIP

Strain Relief Clip

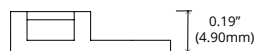
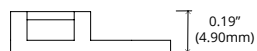
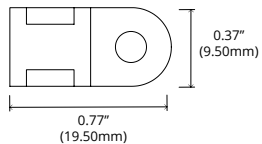
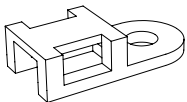

FLEXMNT.SIL.INT

Indoor Mounting Clip

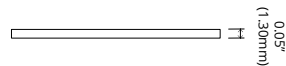
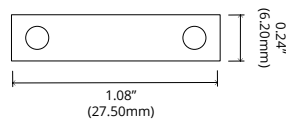
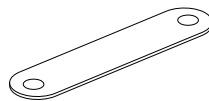

FLEXMNT.SIL.EXT12

Outdoor Mounting Clip

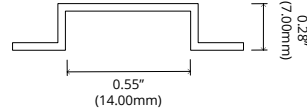
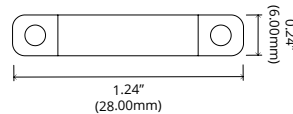
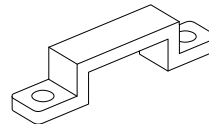

ACCESSORIES

FLEXDC.PFC.02.08

Field installed FLEX Connect® power feed
- 2 Conductor for 8mm Strip

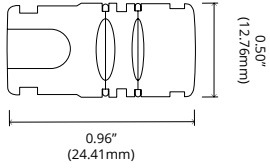

Fits in all channel **except**:

- CHS-R-1208
- CHS-R-1715
- CHC-S-1921
- CHSP-R-2970
- CHSP-S-1618
- CHSP-STEP-8142

FLEXDC.BSC.02.08

Field installed FLEX Connect® butt splice -
2 Conductor for 8mm Strip

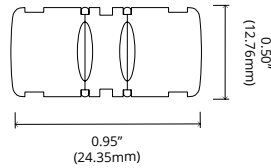

Fits in all channel **except**:

- CHS-R-1208
- CHS-R-1715
- CHC-S-1921
- CHSP-R-2970
- CHSP-S-1618
- CHSP-STEP-8142

LO-18G-2C-W-72

6' wire lead for FLEX Connect®
(not in-wall rated)

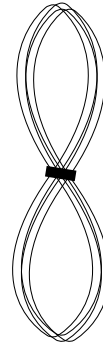

LP-18G-2C-W-72

6' Plenum rated wire lead for
FLEX Connect®

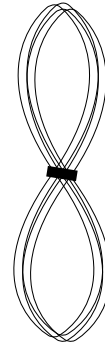

LO-18G-2C-W-SP

1000' spool of wire for
FLEX Connect® (not in-wall rated)

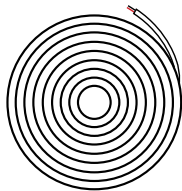

LP-18G-2C-W-SP

500' box of Plenum rated wire for
FLEX Connect®

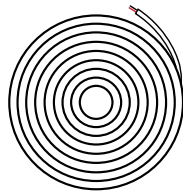

FLEXDC-PFC-HO-1208-SS-KIT

FLEX Connect® housing for
CHS-S-1208

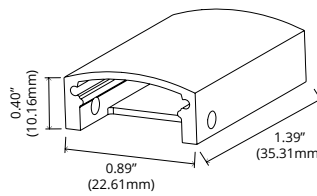

FLEXDC-PFC-HO-1715-SS-KIT

FLEX Connect® housing for
CHS-S-1715

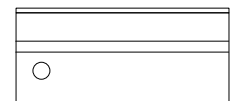
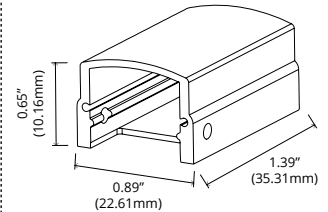

CONFIGURATION TYPES

① FLEX cut to length with FLEX Connect® Power Feeds for Field Termination, Channel uncut for field cutting

- Specify **FLEXConfig-1**
- Specify FLEX type and channel type
- FLEX factory cut to length, but not terminated
- One FLEX Connect® power feed connector and 6' lead provided per FLEX run
 - Uncut rolls of lead wire can also be provided (see page 8 for part #)
- Channel shipped uncut for field cutting.
- Specify number of butt splices (not shown - see page 8)
- IP68 not available in **FLEXConfig-1**
- JA8 2016 not available in **FLEXConfig-1**
- FLEXConfig-1** is quick ship if run lengths are provided at time of order. Take offs, if needed, will add lead time.
- The below channels are **NOT** compatible with FLEX Connect®:
 - Slim:**
 - CHS-R-1208
 - CHS-R-1715
 - CHS-C-1616
 - CHC-S-1921
 - Specialty:**
 - CHSP-R-2970
 - CHSP-S-1618
 - CHSP-STEP-8142

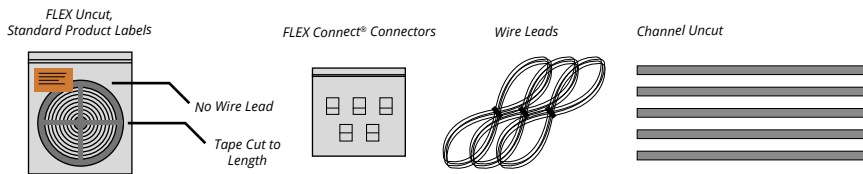

② Cut To Length With Soldered Leads, Assemble On-Site^{1, 2, 3}

- Specify **FLEXConfig-2**
- Specify FLEX type and channel type
- Specify run lengths
- IP68 only available in **FLEXConfig-2**
- If no config is specified, and run lengths are provided, **FLEXConfig-2** will be used

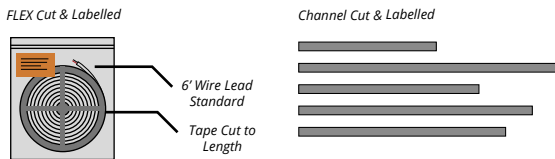

③ Pre-Assembled Factory Finished Fixtures^{1, 2}

- Specify **FLEXConfig-3**
- Fully assembled fixture
- ETL stamped and listed as a fixture
- 6.50' max length
- Standard 6' power lead unless otherwise specified
- The below channels **CANNOT** be factory assembled:
 - Slim:**
 - CHS-R-1208
 - CHS-R-1715
 - Wide:**
 - CHW-R-2010
 - CHW-S-2027
 - CHW-S-7532
 - CHW-S-2623
 - CHW-S-3030
 - CHW-S-3561

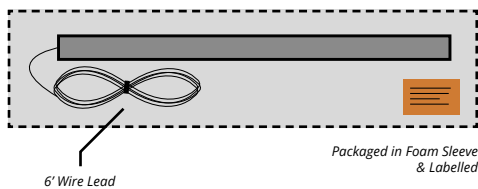

NOTES:

- Due to the nature of the FLEX DC® product, specific lengths may not fall exactly on a cutting point. In this case, Optic Arts® will always cut to the smaller dimension unless otherwise specified.
- Unless otherwise specified, channel is cut 15mm longer than FLEX DC®.
- Some on-site assembly required. See installation guides for details.

COMPATIBLE DRIVERS

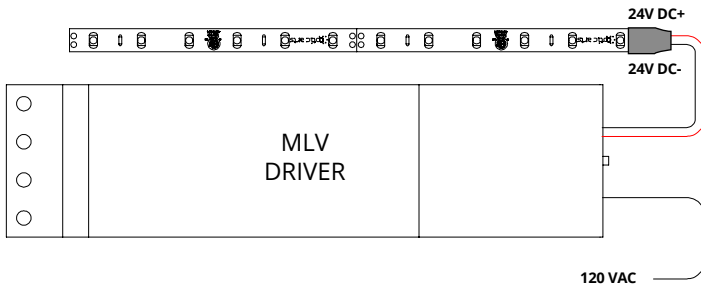

MLV (MLV)

PART	DESCRIPTION
ML10S24VDC	10W 120VAC DIMMABLE DRIVER
ML20S24VDC	20W 120VAC DIMMABLE DRIVER
ML35S24VDC	35W 120VAC DIMMABLE DRIVER
ML35S24VDC-277	35W 277VAC DIMMABLE DRIVER
ML40S24VDC	40W 120VAC DIMMABLE DRIVER
ML50S24VDC	50W 120VAC DIMMABLE DRIVER
ML50S24VDC-277	50W 277VAC DIMMABLE DRIVER
ML60S24VDC	60W 120VAC DIMMABLE DRIVER
ML75S24VDC	75W 120VAC DIMMABLE DRIVER
ML75S24VDC-277	75W 277VAC DIMMABLE DRIVER
ML96S24VDC	96W 120VAC DIMMABLE DRIVER
ML96S24VDC-277	96W 120VAC DIMMABLE DRIVER
EM2-200S24DC	200W 120VAC DIMMABLE DRIVER, 2 96W CIRCUITS
EM3-300S24DC	300W 120VAC DIMMABLE DRIVER, 3 96W CIRCUITS
EM2-200S24DC-277	200W 120VAC DIMMABLE DRIVER, 2 96W CIRCUITS
EM3-300S24DC-277	288W 120VAC DIMMABLE DRIVER, 3 96W CIRCUITS

DIMENSIONS

10W-50W	H 2.11"; W 7.38"; D 1.60"
60W-96W	H 3.93"; W 8.13"; D 1.59"
200-300W	H 5.69"; W 10.29"; D 3.13"

DIMMING PERFORMANCE

MLV DRIVER Dims to 20% on most MLV dimmers

NOTE: Must be loaded between 75%-100% of rated load to maintain FLEX DC® warranty

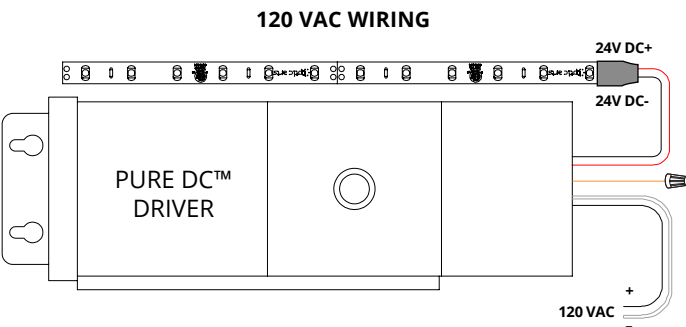

PURE DC™ MLV (PDC)

PART	DESCRIPTION
PDC.40.24	40W 120/277VAC PURE DC™ MLV DIMMABLE DRIVER
PDC.96.24	96W 120/277VAC PURE DC™ MLV DIMMABLE DRIVER

DIMENSIONS

40W	L 14.25"; W 3.00"; H 2.88"
96W	L 14.75"; W 4.31"; H 4.81"

DIMMING PERFORMANCE

PURE DC™ DRIVER Dims to 0.1% on most MLV dimmers

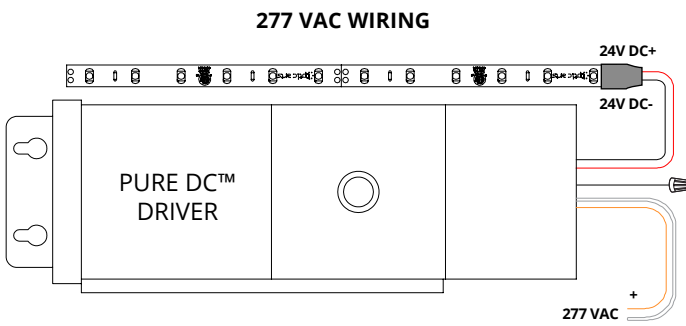

COMPATIBLE DRIVERS

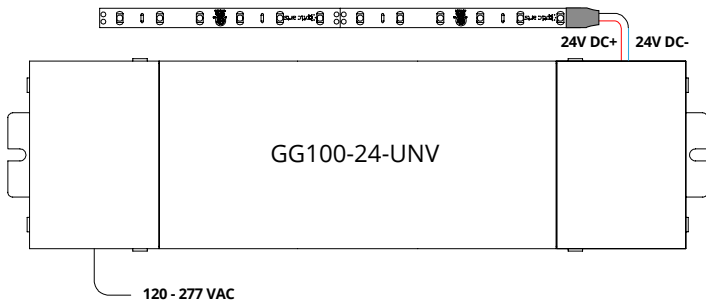

ELECTRONIC DRIVER - NON-DIM (ND)

PART	DESCRIPTION
GG100E-24-UNV	96W 120-277VAC ELECTRONIC DRIVER
DIMENSIONS	
ELECTRONIC DRIVER	H 3.00"; W 11.46"; D 1.30"
DIMMING PERFORMANCE	
ELECTRONIC DRIVER	Non-Dim

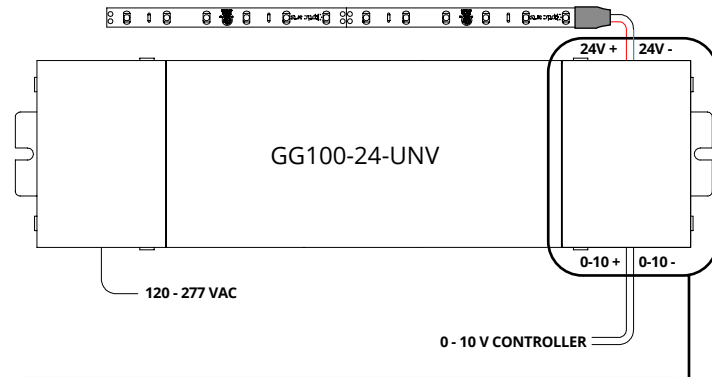

ELECTRONIC DRIVER W/0-10V MODULE (010)

PART	DESCRIPTION
GG100E-24-UNV-010V	96W 120-277VAC ELECTRONIC DRIVER WITH 0-10V DIMMING MODULE (SINK)
DIMENSIONS	
ELECTRONIC DRIVER - 0-10V	H 3.00"; W 11.46"; D 1.30"
DIMMING PERFORMANCE	
ELECTRONIC DRIVER - 0-10V	Dims below 1% on most 0-10V dimmers

FIELD INSTALLED IN LOW VOLTAGE WIRING COMPARTMENT

- Install DIM-010V Module in low voltage wiring compartment.
- Max number of 25 modules on one dimmer. Consult dimmer datasheet for maximum device limitation of a specific controller.

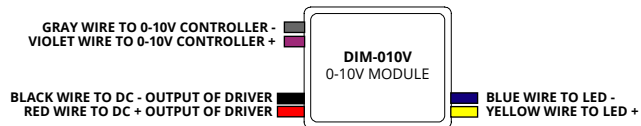

COMPATIBLE DRIVERS

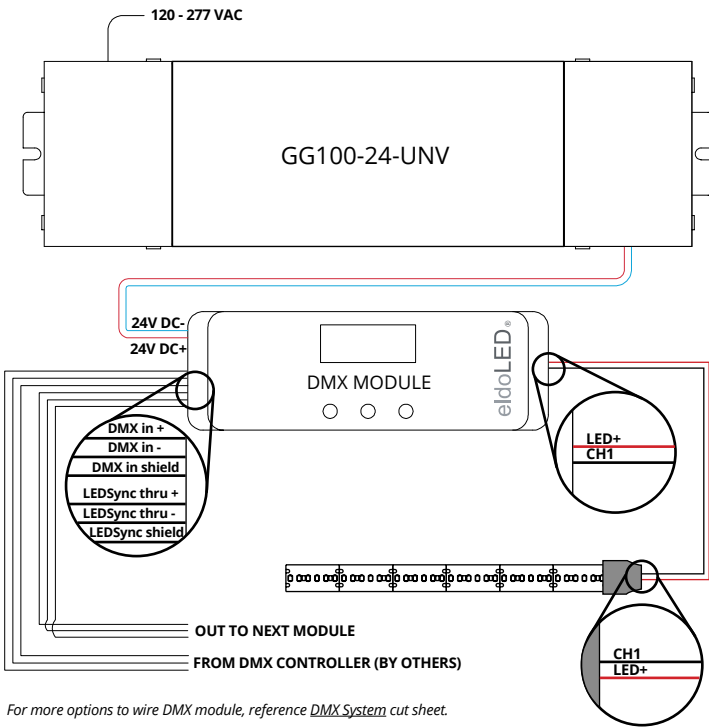

For more options to wire DMX module, reference [DMX System](#) cut sheet.

ELECTRONIC DRIVER W/DMX MODULE (DMX)

PART	DESCRIPTION
GG100E-24-UNV-DMX	96W 120-277VAC ELECTRONIC DRIVER WITH eldoLED DMX DIMMING MODULE

DIMENSIONS	
96W	H 3.00"; W 11.46"; D 1.30"
DMX MODULE	H 1.97"; W 6.02"; D 0.91"

*Must be installed in UL box (by others)

DIMMING PERFORMANCE	
ELECTRONIC DRIVER - DMX MODULE	Dims to 0.1% on most DMX systems

COMPATIBLE DRIVERS

DIMMER WITH NEUTRAL

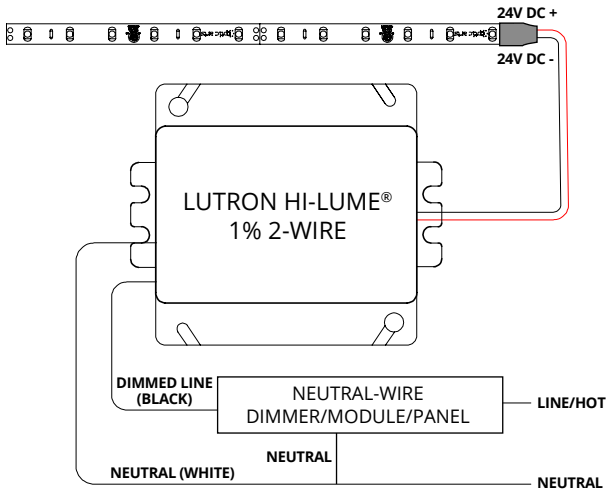

DIMMER WITHOUT NEUTRAL

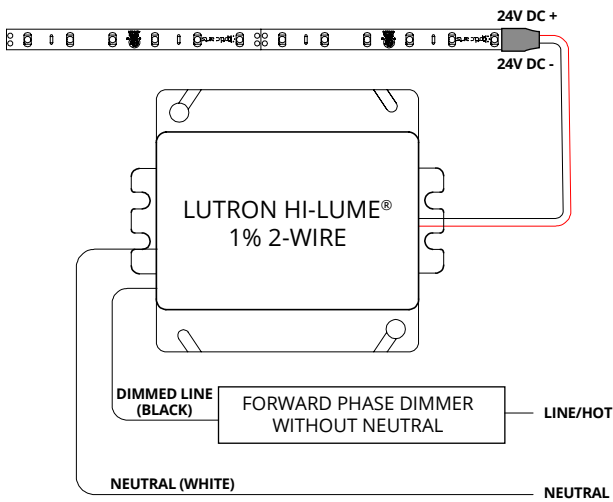

LUTRON HI-LUME® 1% 2-WIRE: 2-WIRE CONTROL FORWARD PHASE



PART	DESCRIPTION
LTEA4U1UKL-CV240	5-40W, 120VAC, 2-WIRE FORWARD PHASE DRIVER
DIMENSIONS	
HI-LUME® 1% 2-WIRE	H 4.00"; W 4.89"; D 2.62"
DIMMING PERFORMANCE	
LUTRON HI-LUME® 1% 2-WIRE	Dims to 1% with compatible Lutron controls

COMPATIBLE DRIVERS

3-WIRE

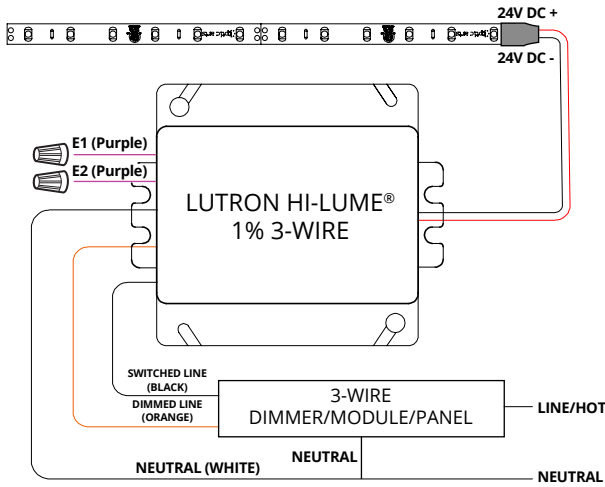

ECOSYSTEM

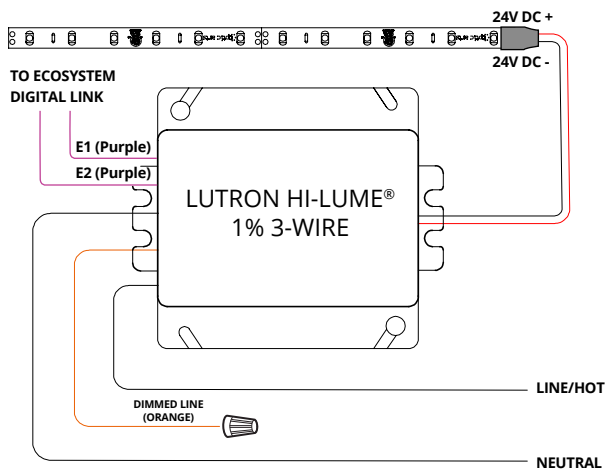

LUTRON HI-LUME® 1%: 3-WIRE/ECOSYSTEM



PART	DESCRIPTION
L3DA4U1UKL-CV240	5-40W, 120-277VAC, 3-WIRE/ECOSYSTEM DRIVER

DIMENSIONS	
HI-LUME® 1%	H 4.00"; W 4.89"; D 2.62"

DIMMING PERFORMANCE	
LUTRON HI-LUME® 1% 3-WIRE/ ECOSYSTEM	Dims to 1% with compatible Lutron controls

COMPATIBLE DRIVERS

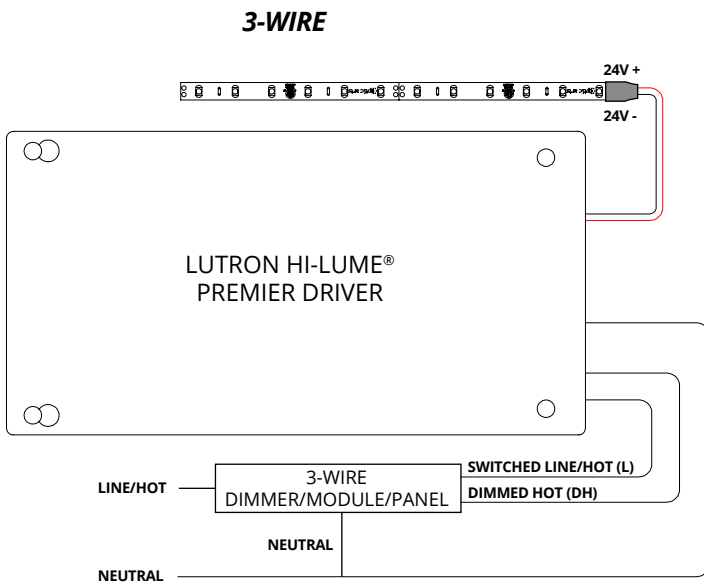

LUTRON HI-LUME® PREMIER:
3-WIRE/ECOSYSTEM



PART	DESCRIPTION
L3D0-96W24V-U	2-96W, 120-277VAC, 3-WIRE/ECOSYSTEM DRIVER

DIMENSIONS	
HI-LUME® PREMIER	H 5.5"; W 10.5"; D 2.0"

DIMMING PERFORMANCE	
LUTRON HI-LUME® PREMIER	Dims to 0.1% with compatible Lutron controls

NOTE: Lutron soft-on, fade to black technology available with Ecosystem Digital Control only.

