

FLEX DC® 22 is a high performance flexible LED fixture suitable for use in coves, under cabinets, in shelves, in-grade, and virtually anywhere a linear fixture is required.

ELECTRICAL

Input Voltage	24VDC
Dimming Options	<ul style="list-style-type: none"> • PURE DC™ • MLV • 0-10V • DMX • Lutron (2-WIRE, 3-WIRE, EcoSystem)
Power Consumption	2.2 Watts per foot
Wire Size	18AWG, 2 wire
Certification	<p>ETL - Conforms to UL Std. 2108; Certified to CSA Std. C22.2 No. 9.0</p> <p>Closet Rated - Suitable for installation in the storage area of a clothes closet when used in Optic Arts® channel.</p> <p>Title 24 - Selected models are JA8 2016 compliant when used with 0-10V, DMX, or Lutron Premier dimming. JA8 option must be specified in part number builder below.</p>

PHYSICAL

Field Cuttable	Every 6.55"
Operating Temperature	-40° C (-40°F) to +70°C (+158°F)
Environment	<p>IP40 - Dry Location</p> <p>IP68 - Wet Location</p>
Maximum Run Length	IP40: 43', IP68: 43'
Dimensions (WxH)	<p>IP40 - 0.40" (10.05mm) x 0.10" (2.33mm)</p> <p>IP68 - 0.50" (12.70mm) x 0.20" (5.15mm)</p> <p>IP68 Endcaps - 0.57" (14.48mm) x 0.38" (9.65mm)</p>

ACCESSORIES

Mounting Clips	FLEXMNT.SIL.INT, FLEXMNT.SIL.EXT12 (pg. 7)
Channels	Optic Arts® Channel (pg. 3-6)
Connectors	LC-I2P-M, LC-I2P-F, LC-O2P-F, LC-O2P-M (pg. 7)
FLEXConfig-1 Accessories	FLEXDC.PFC.02.10, FLEXDC.BSC.02.10, LO-18G-2C-W-72, LP-18G-2C-W-72, LO-18G-2C-W-SP, LP-18G-2C-W-SP (pg. 8)

LUMEN OUTPUT

2000K (IP40 only)	183 lm/ft 83.27 lm/Watt
2400K	196 lm/ft 89.10 lm/Watt
2700K	194 lm/ft 88.00 lm/Watt
3000K	206 lm/ft 93.70 lm/Watt
3000K JA8 2016 (IP40 only) ¹	206 lm/ft 93.70 lm/Watt
3500K	222 lm/ft 100.80 lm/Watt
4100K	224 lm/ft 101.70 lm/Watt
6000K	207 lm/ft 94.10 lm/Watt

Note: Stated lumen values have a tolerance of +/- 10%.
¹: Must be used with 0-10V, DMX, or Lutron Premier dimming.

PERFORMANCE

CRI	90+
Lumen Maintenance	50,000 Hours
Binning Tolerance	+/- 100K
Warranty	5 years

PART NUMBER BUILDER

SERIES	+	IP RATING	+	COLOR	+	VOLTAGE	+	WATTAGE	+	CONFIGURATION	+	LENGTH						
FLEXDC		<p>40 = IP40 - Dry Location</p> <p>68 = IP68 - Wet Location</p>		<p>20 = 2000K (IP40 only)</p> <p>24 = 2400K</p> <p>27 = 2700K</p> <p>30 = 3000K</p> <p>30J = 3000K JA8 2016 (IP40 only)¹</p> <p>35 = 3500K</p>		41 = 4100K		60 = 6000K		<p>R = Red</p> <p>G = Green</p> <p>B = Blue</p> <p>A = Amber</p>		24 = 24 VDC		22 = 2.2W		<p>FLC1 = FLEX Config 1</p> <p>FLC2 = FLEX Config 2</p> <p>FLC3 = FLEX Config 3</p>		XX = Custom Length

¹: Must be used with 0-10V, DMX, or Lutron Premier dimming.



DIMENSIONS

INDOOR FLEX DC® 22

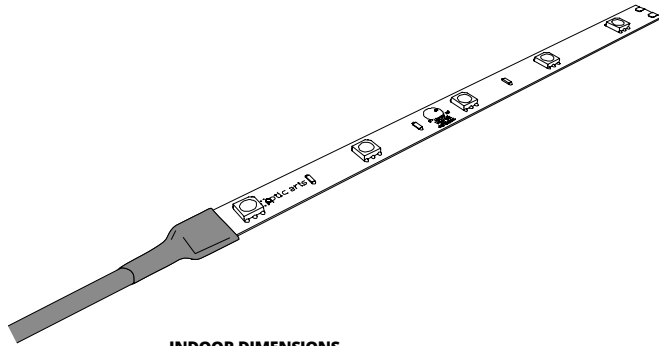
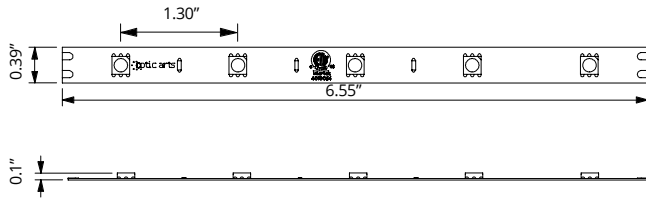

INDOOR DIMENSIONS

Width	0.40" (10.05mm)
Height	0.10" (2.33mm)
Cuttable Segment Length	6.55" (166.37mm)
Pitch Length	1.30" (33.00mm)
Max Run Length	43.00' (13106.40mm)

OUTDOOR FLEX DC® 22

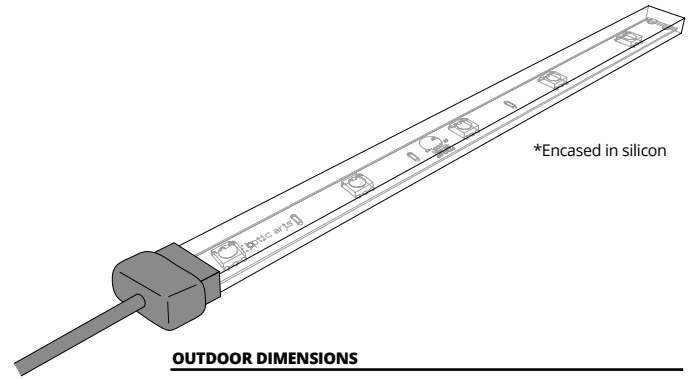
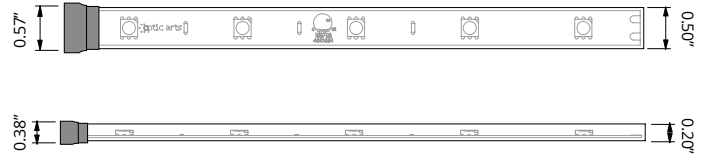

OUTDOOR DIMENSIONS

Width	0.50" (12.70mm)
Height	0.20" (5.15mm)
Width (Endcap)	0.57" (14.48mm)
Height (Endcap)	0.38" (9.65mm)
Max Run Length	43.00' (6096.00mm)

INDOOR FLEX DC® 22

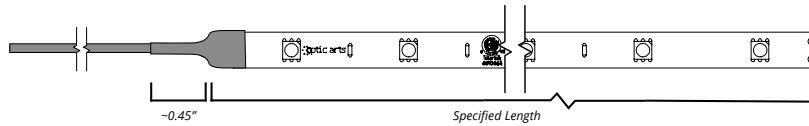

OUTDOOR FLEX DC® 22

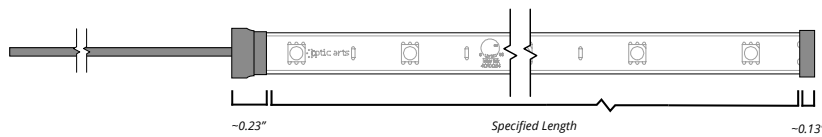

KEY

CHANNEL PART NUMBER BREAKDOWN:

CHS	+	R	+	1208
SERIES		APPLICATION		DIMENSIONS
CHS = Slim Channel CHW = Wide Channel		S = Surface Mount R = Recessed Mount C = Corner Mount H = Hanging Mount		XXXX = W x H (mm)

CHS-R-1208

• Click on channel titles below to access complete channel cut sheets

DIFFUSION LEVEL:

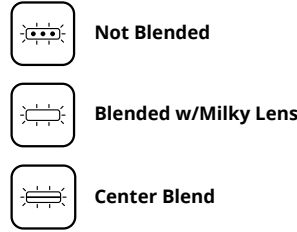

CONFIGURATION:

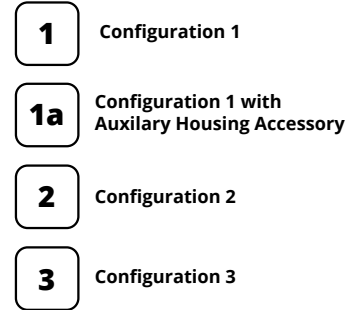

CHS-R-1208

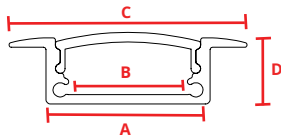

- A:** 0.68" (17.25mm)
- B:** 0.50" (12.59mm)
- C:** 0.98" (25.00mm)
- D:** 0.34" (8.60mm)



MATERIAL	Anodized Aluminum						
DESCRIPTION	Slim and shallow recessed channel.						
LENGTH	2 meter						
LENS TYPES	<table border="0"> <tr><td>Clear</td><td>CHS-12mm-CC</td></tr> <tr><td>Frosted</td><td>CHS-12mm-CF</td></tr> <tr><td>Milky</td><td>CHS-12mm-CM</td></tr> </table>	Clear	CHS-12mm-CC	Frosted	CHS-12mm-CF	Milky	CHS-12mm-CM
Clear	CHS-12mm-CC						
Frosted	CHS-12mm-CF						
Milky	CHS-12mm-CM						
ACCESSORIES	<table border="0"> <tr><td>Endcap</td><td>CHS-R-1208-EC</td></tr> <tr><td>Endcap w/hole</td><td>CHS-R-1208-ECH</td></tr> </table>	Endcap	CHS-R-1208-EC	Endcap w/hole	CHS-R-1208-ECH		
Endcap	CHS-R-1208-EC						
Endcap w/hole	CHS-R-1208-ECH						

CHS-S-1208

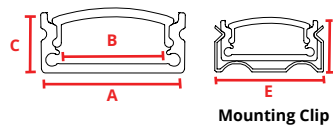

- A:** 0.68" (17.25mm)
- B:** 0.50" (12.59mm)
- C:** 0.34" (8.60mm)
- D:** 0.40" (12.70mm)
- E:** 0.78" (19.90mm)



MATERIAL	Anodized Aluminum								
DESCRIPTION	Slim and shallow surface mounted channel.								
LENGTH	2 meter								
LENS TYPES	<table border="0"> <tr><td>Clear</td><td>CHS-S-12mm-CC</td></tr> <tr><td>Frosted</td><td>CHS-S-12mm-CF</td></tr> <tr><td>Milky</td><td>CHS-S-12mm-CM</td></tr> <tr><td>Grazer</td><td>CHS-S-12mm-CG</td></tr> </table>	Clear	CHS-S-12mm-CC	Frosted	CHS-S-12mm-CF	Milky	CHS-S-12mm-CM	Grazer	CHS-S-12mm-CG
Clear	CHS-S-12mm-CC								
Frosted	CHS-S-12mm-CF								
Milky	CHS-S-12mm-CM								
Grazer	CHS-S-12mm-CG								
ACCESSORIES	<table border="0"> <tr><td>Endcap</td><td>CHS-S-1208-EC</td></tr> <tr><td>Endcap w/hole</td><td>CHS-S-1208-ECH</td></tr> <tr><td>Mounting Clip</td><td>CHS-S-1208-MC</td></tr> <tr><td>Rotating Mounting Clip</td><td>CHS-S-1208-MCR</td></tr> </table>	Endcap	CHS-S-1208-EC	Endcap w/hole	CHS-S-1208-ECH	Mounting Clip	CHS-S-1208-MC	Rotating Mounting Clip	CHS-S-1208-MCR
Endcap	CHS-S-1208-EC								
Endcap w/hole	CHS-S-1208-ECH								
Mounting Clip	CHS-S-1208-MC								
Rotating Mounting Clip	CHS-S-1208-MCR								

CHS-C-1919

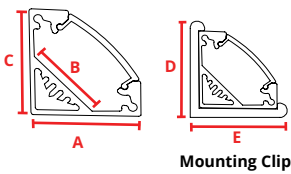

- A:** 0.73" (18.50mm)
- B:** 0.48" (12.20mm)
- C:** 0.73" (18.50mm)
- D:** 0.82" (20.82mm)
- E:** 0.82" (20.82mm)



MATERIAL	Anodized Aluminum						
DESCRIPTION	Slim corner mount channel.						
LENGTH	2 meter						
LENS TYPES	<table border="0"> <tr><td>Clear</td><td>CHS-12mm-CC</td></tr> <tr><td>Frosted</td><td>CHS-12mm-CF</td></tr> <tr><td>Milky</td><td>CHS-12mm-CM</td></tr> </table>	Clear	CHS-12mm-CC	Frosted	CHS-12mm-CF	Milky	CHS-12mm-CM
Clear	CHS-12mm-CC						
Frosted	CHS-12mm-CF						
Milky	CHS-12mm-CM						
ACCESSORIES	<table border="0"> <tr><td>Endcap</td><td>CHS-C-1919-EC</td></tr> <tr><td>Endcap w/hole</td><td>CHS-C-1919-ECH</td></tr> <tr><td>Mounting Clip</td><td>CHS-C-1919-MC</td></tr> </table>	Endcap	CHS-C-1919-EC	Endcap w/hole	CHS-C-1919-ECH	Mounting Clip	CHS-C-1919-MC
Endcap	CHS-C-1919-EC						
Endcap w/hole	CHS-C-1919-ECH						
Mounting Clip	CHS-C-1919-MC						

CHS-R-1715

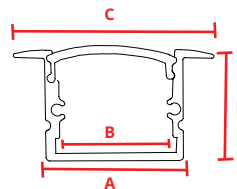

- A:** 0.68" (17.25mm)
- B:** 0.48" (12.30mm)
- C:** 0.98" (25.00mm)
- D:** 0.59" (15.05mm)



MATERIAL	Anodized Aluminum								
DESCRIPTION	Slim and deep recessed channel. Eliminates visible LED nodes when used with FLEXDC 3.0 and milky lens.								
LENGTH	2 meter								
LENS TYPES	<table border="0"> <tr><td>Clear</td><td>CHS-12mm-CC</td></tr> <tr><td>Frosted</td><td>CHS-12mm-CF</td></tr> <tr><td>Milky</td><td>CHS-12mm-CM</td></tr> <tr><td>Grazer</td><td>CHS-12mm-CG</td></tr> </table>	Clear	CHS-12mm-CC	Frosted	CHS-12mm-CF	Milky	CHS-12mm-CM	Grazer	CHS-12mm-CG
Clear	CHS-12mm-CC								
Frosted	CHS-12mm-CF								
Milky	CHS-12mm-CM								
Grazer	CHS-12mm-CG								
ACCESSORIES	<table border="0"> <tr><td>Endcap</td><td>CHS-R-1715-EC</td></tr> <tr><td>Endcap w/hole</td><td>CHS-R-1715-ECH</td></tr> </table>	Endcap	CHS-R-1715-EC	Endcap w/hole	CHS-R-1715-ECH				
Endcap	CHS-R-1715-EC								
Endcap w/hole	CHS-R-1715-ECH								

MOUNTING OPTIONS - COMPATIBLE CHANNELS

- Not Blended
 Blended w/Milky Lens
 1 Configuration 1
 1a Configuration 1 with Auxiliary Housing Accessory
 2 Configuration 2
 3 Configuration 3

CHS-S-1715

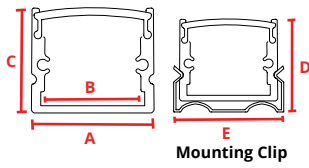

- A:** 0.68" (17.25mm)
- B:** 0.48" (12.30mm)
- C:** 0.59" (15.05mm)
- D:** 0.66" (16.76mm)
- E:** 0.78" (19.90mm)



MATERIAL

Anodized Aluminum



DESCRIPTION

Slim and deep surface mounted channel. Eliminates visible LED nodes when used with FLEXDC 3.0 and milky lens.



LENGTH

2 meter



LENS TYPES

Clear	CHS-12mm-CC
Frosted	CHS-12mm-CF
Milky	CHS-12mm-CM
Grazer	CHS-12mm-CG

ACCESSORIES

Endcap	CHS-S-1715-EC
Endcap w/hole	CHS-S-1715-ECH
Mounting Clip	CHS-S-1715-MC
Rotating Mounting Clip	CHS-S-1208-MCR

CHS-C-1616

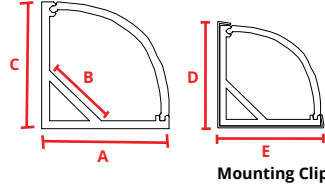

- A:** 0.63" (16.00mm)
- B:** 0.39" (10.00mm)
- C:** 0.63" (16.00mm)
- D:** 0.70" (17.78mm)
- E:** 0.70" (17.78mm)



MATERIAL

Anodized Aluminum



DESCRIPTION

Slim corner mount channel with rounded lens.



LENGTH

2 meter

LENS TYPES

Frosted	CHS-C-1616-CF
Milky	CHS-C-1616-CM

ACCESSORIES

Endcap	CHS-C-1616-EC
Endcap w/hole	CHS-C-1616-ECH
Mounting Clip	CHS-C-1616-MC

CHS-S-1922S

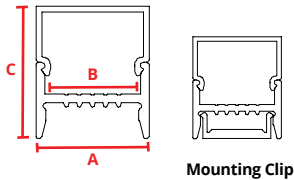

- A:** 0.77" (19.50mm)
- B:** 0.65" (16.50mm)
- C:** 0.86" (21.80mm)



MATERIAL

Anodized Aluminum



DESCRIPTION

Slim surface mounted channel with square wrap around lens. Mounting clip is fully concealed within fixture base.



LENGTH

2 meter



LENS TYPES

Milky	CHW-S-1922S-CM
-------	----------------

ACCESSORIES

Endcap	CHS-S-1922S-EC
Endcap w/hole	CHS-S-1922S-ECH
Mounting Clip	CHS-S-1922S-MC

CHS-S-1922R

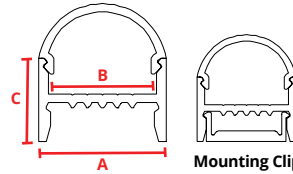

- A:** 0.77" (19.50mm)
- B:** 0.65" (16.50mm)
- C:** 0.86" (21.80mm)



MATERIAL

Anodized Aluminum



DESCRIPTION

Slim surface mounted channel with rounded wrap around lens. Mounting clip is fully concealed within fixture base.



LENGTH

2 meter



LENS TYPES

Milky	CHW-S-1922R-CM
-------	----------------

ACCESSORIES

Endcap	CHS-S-1922R-EC
Endcap w/hole	CHS-S-1922R-ECH
Mounting Clip	CHS-S-1922R-MC

CHW-S-2010

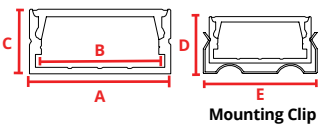

- A:** 0.93" (23.50mm)
- B:** 0.78" (20.00mm)
- C:** 0.39" (10.00mm)
- D:** 0.48" (12.19mm)
- E:** 1.02" (25.80mm)



MATERIAL

Anodized Aluminum



DESCRIPTION

Low profile surface mounted channel.



LENGTH

2 meter



LENS TYPES

Clear	CHW-S-2010-CC
Frosted	CHW-S-2010-CF
Milky	CHW-S-2010-CM

ACCESSORIES

Endcap	CHW-S-2010-EC
Endcap w/hole	CHW-S-2010-ECH
Mounting Clip	CHW-S-2010-MC
Rotating Mounting Clip	CHW-S-2010-MCR

CHW-R-2010

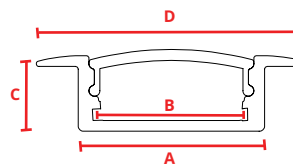

- A:** 0.93" (23.50mm)
- B:** 0.78" (20.00mm)
- C:** 0.39" (10.00mm)
- D:** 1.19" (30.24mm)



MATERIAL

Anodized Aluminum



DESCRIPTION

Recessed wide-profile channel.



LENGTH

2 meter

LENS TYPES

Clear	CHW-R-2010-CC
Frosted	CHW-R-2010-CF
Milky	CHW-R-2010-CM

ACCESSORIES

Endcap	CHW-R-2010-EC
Endcap w/hole	CHW-R-2010-ECH

MOUNTING OPTIONS - COMPATIBLE CHANNELS

- Not Blended
 Blended w/Milky Lens
 1 Configuration 1
 1a Configuration 1 with Auxiliary Housing Accessory
 2 Configuration 2
 3 Configuration 3

CHW-C-3030

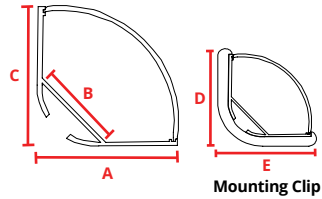

- A:** 1.18" (30.00mm)
B: 0.78" (20.20mm)
C: 1.18" (30.00mm)
D: 1.29" (32.77mm)
E: 1.29" (32.77mm)



MATERIAL

Anodized Aluminum



DESCRIPTION

45 degree channel with rounded lens.



LENGTH

2 meter



LENS TYPES

Clear	CHW-C-3030-CC
Frosted	CHW-C-3030-CF
Milky	CHW-C-3030-CM

ACCESSORIES

Endcap	CHW-C-3030-EC
Endcap w/hole	CHW-C-3030-ECH
Mounting Clip	CHW-C-3030-MC

CHW-C-3030S

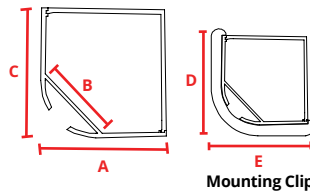

- A:** 1.18" (30.00mm)
B: 0.78" (20.20mm)
C: 1.18" (30.00mm)
D: 1.29" (32.77mm)
E: 1.29" (32.77mm)



MATERIAL

Anodized Aluminum



DESCRIPTION

45 degree channel with square lens.



LENGTH

2 meter



LENS TYPES

Clear	CHW-C-3030S-CC
Frosted	CHW-C-3030S-CF
Milky	CHW-C-3030S-CM

ACCESSORIES

Endcap	CHW-C-3030S-EC
Endcap w/hole	CHW-C-3030S-ECH
Mounting Clip	CHW-C-3030S-MC

CHW-S/H-3535

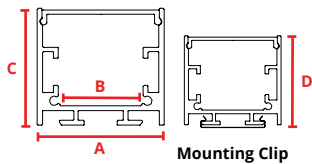

- A:** 1.39" (35.25mm)
B: 0.96" (24.50mm)
C: 1.39" (35.25mm)
D: 1.54" (39.00mm)

*Must specify for hanging or surface mount application.



MATERIAL

Anodized Aluminum



DESCRIPTION

Wide and deep surface mounted or hanging channel. Eliminates visible LED nodes for most FLEXDC products when used with a milky lens.



LENGTH

2 meter



LENS TYPES

Frosted	CHW-35mm-CF
Milky	CHW-35mm-CM

ACCESSORIES

Endcap	CHW-S-3535-EC
Endcap w/hole	CHW-S-3535-ECH
Mounting Clip	CHW-S-3535-MC
Hanging Hardware	CHW-SH-3535-MW
Bracket Straight	CHW-S-XX35-BS
Bracket 90° Flat	CHW-S-XX35-B90F
Bracket 90° Raised	CHW-S-XX35-B90R
End Cap for FLEX AC	CHW-S-3535-ECAC
Mounting Clip for FLEX AC	CHW-S-3535-MCAC
VHB Tape	VHBTAPE.AC

CHW-R-4435

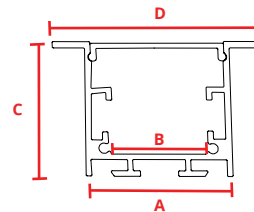

- A:** 1.39" (35.25mm)
B: 0.96" (24.50mm)
C: 1.39" (35.25mm)
D: 2.00" (51.04mm)



MATERIAL

Anodized Aluminum



DESCRIPTION

Wide and deep recessed channel. Eliminates visible LED nodes for most FLEXDC products when used with a milky lens. Can be securely and conveniently mounted with CHW-R-4435-SC spring clip.



LENGTH

2 meter



LENS TYPES

Frosted	CHW-35mm-CF
Milky	CHW-35mm-CM

ACCESSORIES

Endcap	CHW-R-4435-EC
Endcap w/hole	CHW-R-4435-ECH
Mounting Clip	CHW-R-4435-SC
Bracket Straight	CHW-S-XX35-BS
Bracket 90° Flat	CHW-S-XX35-B90F
Bracket 90° Raised	CHW-S-XX35-B90R
End Cap for FLEX AC	CHW-R-4435-ECAC
Mounting Clip for FLEX AC	CHW-R-4435-MCAC
VHB Tape	VHBTAPE.AC

CHW-S/H-2027

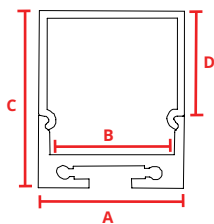

- A:** 0.79" (20.30mm)
B: 0.66" (16.70mm)
C: 1.06" (27.00mm)
D: 0.76" (19.50mm)

*Must specify for hanging or surface mount application.



MATERIAL

Anodized Aluminum



DESCRIPTION

Small surfaced mounted or hanging channel with wrap around lens.



LENGTH

2 meter



LENS TYPES

Clear	CHW-SH-2027-CC
Frosted	CHW-SH-2027-CF
Milky	CHW-SH-2027-CM

ACCESSORIES

Endcap	CHW-SH-2027-EC
End Cap w/hole	CHW-SH-2027-ECH
Hanging Hardware	CHW-SH-MW
Bracket Straight	CHW-SH-BS
Bracket 90° Flat	CHW-SH-B90F
Bracket 90° Raised	CHW-SH-B90R

CHW-S/H-3561

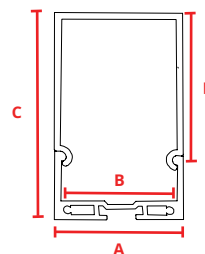

- A:** 1.38" (35.00mm)
B: 1.24" (31.40mm)
C: 2.43" (61.70mm)
D: 1.57" (39.90mm)

*Must specify for hanging or surface mount application.



MATERIAL

Anodized Aluminum



DESCRIPTION

Large surface mounted or hanging channel with wrap around lens.



LENGTH

2 meter



LENS TYPES

Milky	CHW-SH-3561-CM
-------	----------------

ACCESSORIES

Endcap	CHW-SH-3561-EC
End Cap w/hole	CHW-SH-3561-ECH
Hanging Hardware	CHW-SH-MW
Bracket Straight	CHW-SH-BS
Bracket 90° Flat	CHW-SH-B90F
Bracket 90° Raised	CHW-SH-B90R

MOUNTING OPTIONS - COMPATIBLE CHANNELS

- Not Blended
 Blended w/Milky Lens
 1 Configuration 1
 1a Configuration 1 with Auxiliary Housing Accessory
 2 Configuration 2
 3 Configuration 3

CHW-S/H-7532

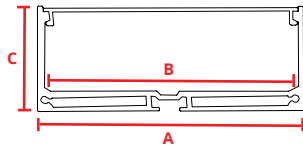

- A:** 2.95" (75.00mm)
- B:** 2.52" (64.00mm)
- C:** 1.26" (32.00mm)

**Must specify for hanging or surface mount application.*



MATERIAL
Anodized Aluminum



DESCRIPTION
Wide surface mounted or hanging channel with flat lens.



LENGTH
2 meter



LENS TYPES
Frosted CHW-SH-7532-CF

ACCESSORIES

Endcap	CHW-SH-7532-EC
Endcap w/hole	CHW-SH-7532-ECH
Hanging Hardware	CHW-SH-MW
Bracket Straight	CHW-SH-BS
Bracket 90° Flat	CHW-SH-B90F
Bracket 90° Raised	CHW-SH-B90R

CHW-S-2623

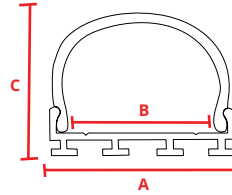

- A:** 1.03" (26.20mm)
- B:** 0.80" (20.35mm)
- C:** 0.89" (22.76mm)



MATERIAL
Anodized Aluminum



DESCRIPTION
Surface mounted channel with wrap around lens.



LENGTH
2 meter



LENS TYPES
Milky CHW-S-2623-CM

ACCESSORIES

Endcap	CHW-S-2623-EC
Endcap w/hole	CHW-S-2623-ECH

CHW-S/H-3030

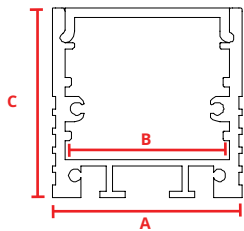

- A:** 1.18" (30.00mm)
- B:** 1.01" (25.60mm)
- C:** 1.18" (30.00mm)

**Must specify for hanging or surface mount application.*



MATERIAL
Anodized Aluminum



DESCRIPTION
Wide and deep surface mounted or hanging channel with flat lens for even blending.



LENGTH
2 meter



LENS TYPES
Milky CHW-SH-3030-CM

ACCESSORIES

Endcap	CHW-SH-3030-EC
Endcap w/hole	CHW-SH-3030-ECH
Hanging Hardware	CHW-SH-MW
Bracket Straight	CHW-SH-BS
Bracket 90° Flat	CHW-SH-B90F
Bracket 90° Raised	CHW-SH-B90R
End Cap for FLEX AC	CHW-SH-3030-ECAC
Mounting Clip for FLEX AC	CHW-SH-3030-MCAC
VHB Tape	VHBTape.AC

CHC-S-1921

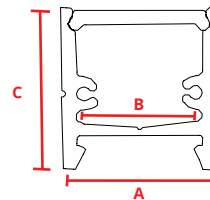

- A:** 0.76" (19.43mm)
- B:** 0.55" (14.09mm)
- C:** 0.84" (21.43mm)



MATERIAL
Anodized Aluminum



DESCRIPTION
Surface mount channel with flat lens. Mounts to ferrous and non-ferrous surfaces using magnets with no visible fasteners once mounted.



LENGTH
2 meter



LENS TYPES
Milky CHC-S-1921-CM

ACCESSORIES

Anodized Aluminum Endcap	CHC-S-1921-EC
Anodized Aluminum Endcap w/hole	CHC-S-1921-ECH
Channel Mounted Magnet	CHC-S-1921-MA
Wall Mounted Magnet	CHC-S-1921-M
1' Mounting Plate	CHC-S-1921-B1

CHSP-S-1618

Fits IP40 FLEX DC®

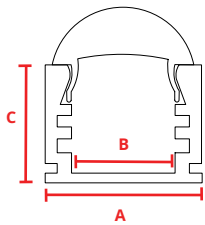

- A:** 0.63" (16.00mm)
- B:** 0.40" (10.16mm)
- C:** 0.49" (11.90mm)



MATERIAL
Anodized Aluminum



DESCRIPTION
Includes an aluminum insert that allows selection between (4) different beamspreads based on the position of the insert.



LENGTH
2 meter



LENS TYPES
Focusing Lens CHSP-S-1618-CFL

ACCESSORIES

Endcap	CHSP-S-1618-EC
Endcap w/hole	CHSP-S-1618-ECH
Mounting Clip	CHSP-S-1618-MC

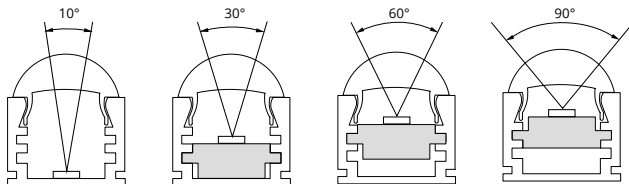

ACCESSORIES

LC-I2P-M

Indoor Lead Connector
(Male)

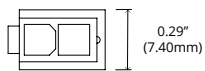
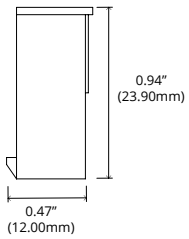
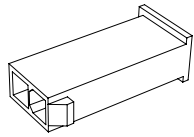

LC-I2P-F

Indoor Lead Connector
(Female)

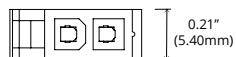
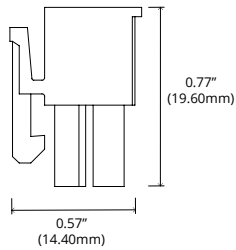
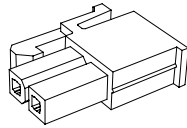

LC-O2P-F

Outdoor Lead Connector
(Female)

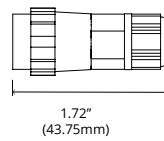
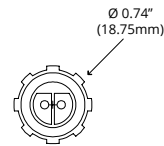
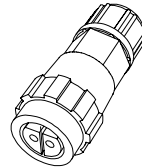

LC-O2P-M

Outdoor Lead Connector
(Male)

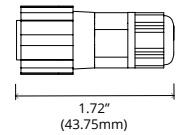
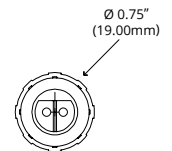
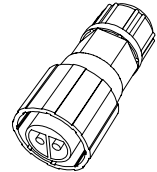

FLEX.ZIP

Strain Relief Clip

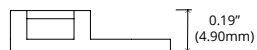
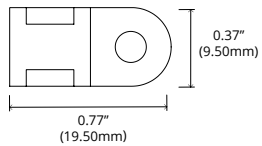
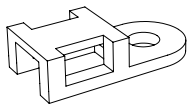

FLEXMNT.SIL.INT

Indoor Mounting Clip

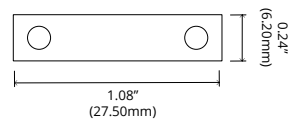
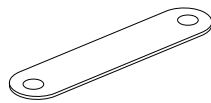

FLEXMNT.SIL.EXT12

Outdoor Mounting Clip

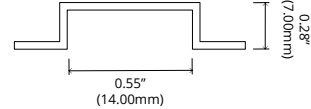
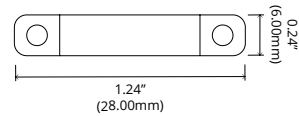
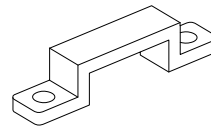

ACCESSORIES

FLEXDC.PFC.02.10

Field installed FLEX Connect® power feed
- 2 Conductor for 10mm Strip

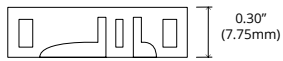
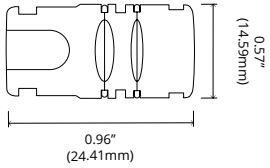

Fits in all channel **except**:

- CHS-R-1208
- CHS-R-1715
- CHS-S-1208
- CHS-S-1715
- CHS-C-1919
- CHS-C-1616
- CHC-S-1921
- CHSP-R-2970
- CHSP-S-1618
- CHSP-STEP-8142

FLEXDC.BSC.02.10

Field installed FLEX Connect® butt splice -
2 Conductor for 10mm Strip

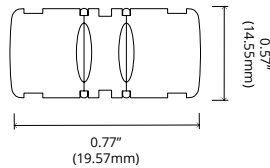

Fits in all channel **except**:

- CHS-R-1208
- CHS-R-1715
- CHS-S-1208
- CHS-S-1715
- CHS-C-1919
- CHS-C-1616
- CHC-S-1921
- CHSP-R-2970
- CHSP-S-1618
- CHSP-STEP-8142

LO-18G-2C-W-72

6' wire lead for FLEX Connect®
(not in-wall rated)

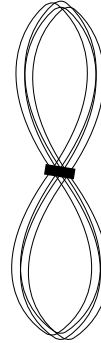

LP-18G-2C-W-72

6' Plenum rated wire lead for
FLEX Connect®

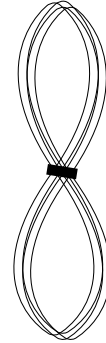

LO-18G-2C-W-SP

1000' spool of wire for
FLEX Connect® (not in-wall rated)

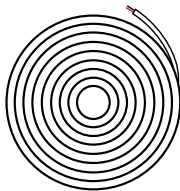

LP-18G-2C-W-SP

500' box of Plenum rated wire for
FLEX Connect®

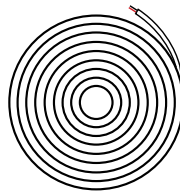

CONFIGURATION TYPES

① FLEX cut to length with FLEX Connect® Power Feeds for Field Termination, Channel uncut for field cutting

- Specify **FLEXConfig-1**
- Specify FLEX type and channel type
- FLEX factory cut to length, but not terminated
- One FLEX Connect® power feed connector and 6' lead provided per FLEX run
 - Uncut rolls of lead wire can also be provided (see page 8 for part #)
- Channel shipped uncut for field cutting.
- Specify number of butt splices (not shown - see page 8)
- IP68 not available in **FLEXConfig-1**
- JA8 2016 not available in **FLEXConfig-1**
- FLEXConfig-1** is quick ship if run lengths are provided at time of order. Take offs, if needed, will add lead time.
- The below channels are **NOT** compatible with FLEX Connect®:
 - Slim:**
 - CHS-R-1208
 - CHS-R-1715
 - CHS-S-1208
 - CHS-S-1715
 - CHS-C-1616
 - CHC-S-1921
 - Specialty:**
 - CHSP-R-2970
 - CHSP-S-1618
 - CHSP-STEP-8142

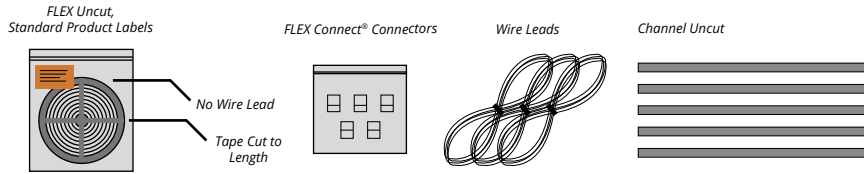

② Cut To Length With Soldered Leads, Assemble On-Site^{1, 2, 3}

- Specify **FLEXConfig-2**
- Specify FLEX type and channel type
- Specify run lengths
- IP68 only available in **FLEXConfig-2**
- If no config is specified, and run lengths are provided, **FLEXConfig-2** will be used

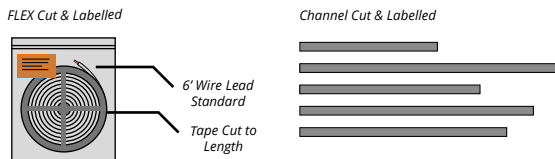

③ Pre-Assembled Factory Finished Fixtures^{1, 2}

- Specify **FLEXConfig-3**
- Fully assembled fixture
- ETL stamped and listed as a fixture
- 6.50' max length
- Standard 6' power lead unless otherwise specified
- The below channels **CANNOT** be factory assembled:
 - Slim:**
 - CHS-R-1208
 - CHS-R-1715
 - Wide:**
 - CHW-R-2010
 - CHW-S-2027
 - CHW-S-7532
 - CHW-S-2623
 - CHW-S-3030
 - CHW-S-3561

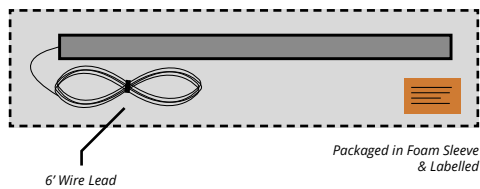

NOTES:

- Due to the nature of the FLEX DC® product, specific lengths may not fall exactly on a cutting point. In this case, Optic Arts® will always cut to the smaller dimension unless otherwise specified.
- Unless otherwise specified, channel is cut 15mm longer than FLEX DC®.
- Some on-site assembly required. See installation guides for details.

COMPATIBLE DRIVERS

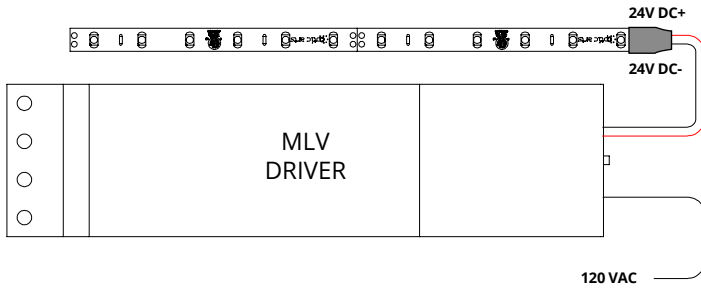

MLV (MLV)

PART	DESCRIPTION
ML10S24VDC	10W 120VAC DIMMABLE DRIVER
ML20S24VDC	20W 120VAC DIMMABLE DRIVER
ML35S24VDC	35W 120VAC DIMMABLE DRIVER
ML35S24VDC-277	35W 277VAC DIMMABLE DRIVER
ML40S24VDC	40W 120VAC DIMMABLE DRIVER
ML50S24VDC	50W 120VAC DIMMABLE DRIVER
ML50S24VDC-277	50W 277VAC DIMMABLE DRIVER
ML60S24VDC	60W 120VAC DIMMABLE DRIVER
ML75S24VDC	75W 120VAC DIMMABLE DRIVER
ML75S24VDC-277	75W 277VAC DIMMABLE DRIVER
ML96S24VDC	96W 120VAC DIMMABLE DRIVER
ML96S24VDC-277	96W 120VAC DIMMABLE DRIVER
EM2-200S24DC	200W 120VAC DIMMABLE DRIVER, 2 96W CIRCUITS
EM3-300S24DC	300W 120VAC DIMMABLE DRIVER, 3 96W CIRCUITS
EM2-200S24DC-277	200W 120VAC DIMMABLE DRIVER, 2 96W CIRCUITS
EM3-300S24DC-277	288W 120VAC DIMMABLE DRIVER, 3 96W CIRCUITS

DIMENSIONS

10W-50W	H 2.11"; W 7.38"; D 1.60"
60W-96W	H 3.93"; W 8.13"; D 1.59"
200-300W	H 5.69"; W 10.29"; D 3.13"

DIMMING PERFORMANCE

MLV DRIVER	Dims to 20% on most MLV dimmers
------------	---------------------------------

NOTE: Must be loaded between 75%-100% of rated load to maintain FLEX DC[®] warranty

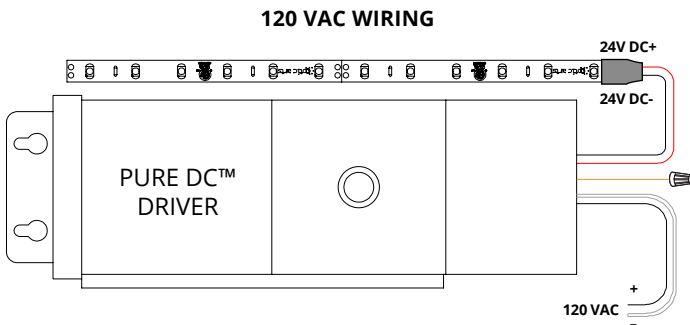

PURE DC[™] MLV (PDC)

PART	DESCRIPTION
PDC.40.24	40W 120/277VAC PURE DC [™] MLV DIMMABLE DRIVER
PDC.96.24	96W 120/277VAC PURE DC [™] MLV DIMMABLE DRIVER

DIMENSIONS

40W	L 14.25"; W 3.00"; H 2.88"
96W	L 14.75"; W 4.31"; H 4.81"

DIMMING PERFORMANCE

PURE DC [™] DRIVER	Dims to 0.1% on most MLV dimmers
-----------------------------	----------------------------------

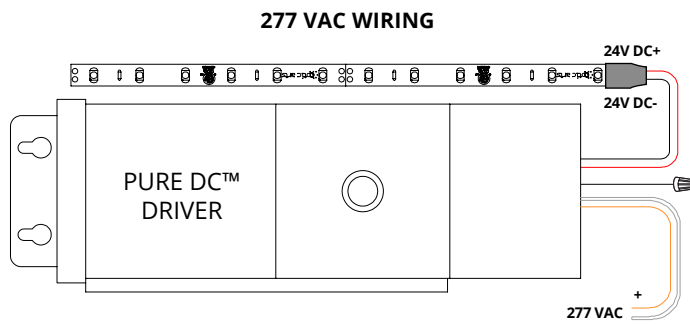

COMPATIBLE DRIVERS

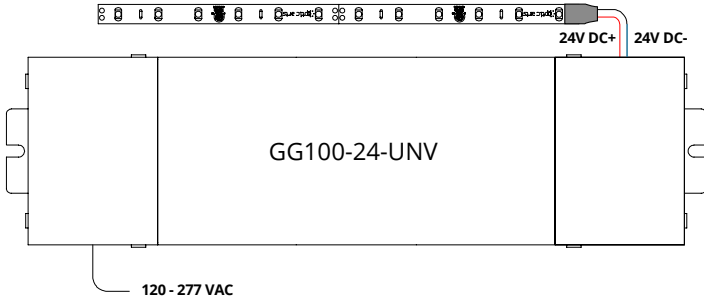

ELECTRONIC DRIVER - NON-DIM (ND)

PART	DESCRIPTION
GG100E-24-UNV	96W 120-277VAC ELECTRONIC DRIVER
DIMENSIONS	
ELECTRONIC DRIVER	H 3.00"; W 11.46"; D 1.30"
DIMMING PERFORMANCE	
ELECTRONIC DRIVER	Non-Dim

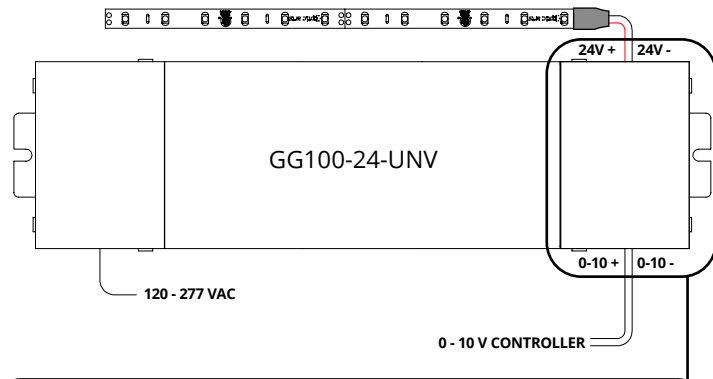

ELECTRONIC DRIVER W/0-10V MODULE (010)

PART	DESCRIPTION
GG100E-24-UNV-010V	96W 120-277VAC ELECTRONIC DRIVER WITH 0-10V DIMMING MODULE (SINK)
DIMENSIONS	
ELECTRONIC DRIVER - 0-10V	H 3.00"; W 11.46"; D 1.30"
DIMMING PERFORMANCE	
ELECTRONIC DRIVER - 0-10V	Dims below 1% on most 0-10V dimmers

FIELD INSTALLED IN LOW VOLTAGE WIRING COMPARTMENT

- Install DIM-010V Module in low voltage wiring compartment.
- Max number of 25 modules on one dimmer. Consult dimmer datasheet for maximum device limitation of a specific controller.

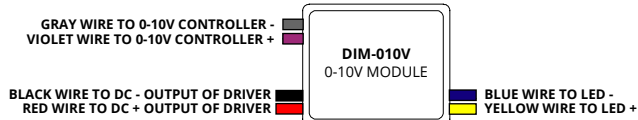

COMPATIBLE DRIVERS

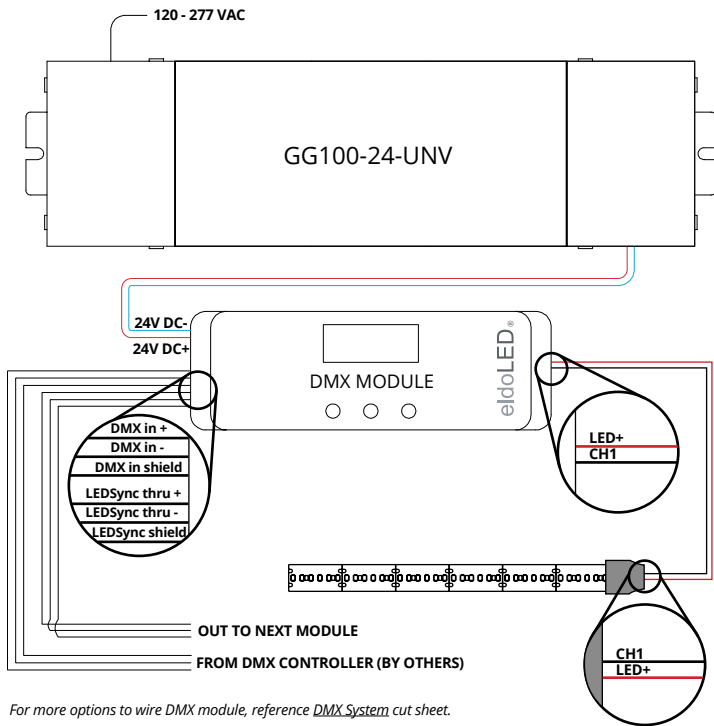

For more options to wire DMX module, reference [DMX System cut sheet](#).

ELECTRONIC DRIVER W/DMX MODULE (DMX)

PART	DESCRIPTION
GG100E-24-UNV-DMX	96W 120-277VAC ELECTRONIC DRIVER WITH eldoLED DMX DIMMING MODULE

DIMENSIONS

96W	H 3.00"; W 11.46"; D 1.30"
DMX MODULE	H 1.97"; W 6.02"; D 0.91"

*Must be installed in UL box (by others)

DIMMING PERFORMANCE

ELECTRONIC DRIVER - DMX MODULE	Dims to 0.1% on most DMX systems
--------------------------------	----------------------------------

COMPATIBLE DRIVERS

DIMMER WITH NEUTRAL

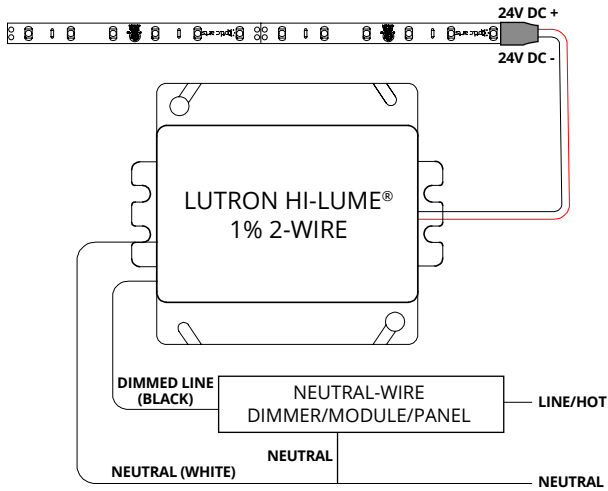

DIMMER WITHOUT NEUTRAL

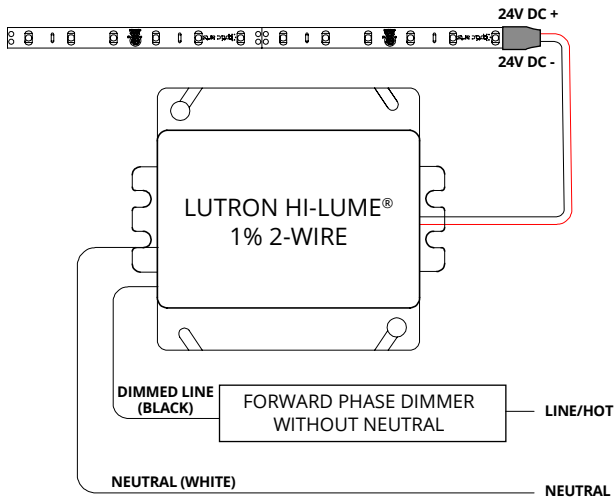

LUTRON HI-LUME® 1% 2-WIRE: 2-WIRE CONTROL FORWARD PHASE



PART	DESCRIPTION
LTEA4U1UKL-CV240	5-40W, 120VAC, 2-WIRE FORWARD PHASE DRIVER
DIMENSIONS	
LUTRON HI-LUME® 1% 2-WIRE	H 4.00"; W 4.89"; D 2.62"
DIMMING PERFORMANCE	
LUTRON HI-LUME® 1% 2-WIRE	Dims to 1% with compatible Lutron controls

COMPATIBLE DRIVERS

3-WIRE

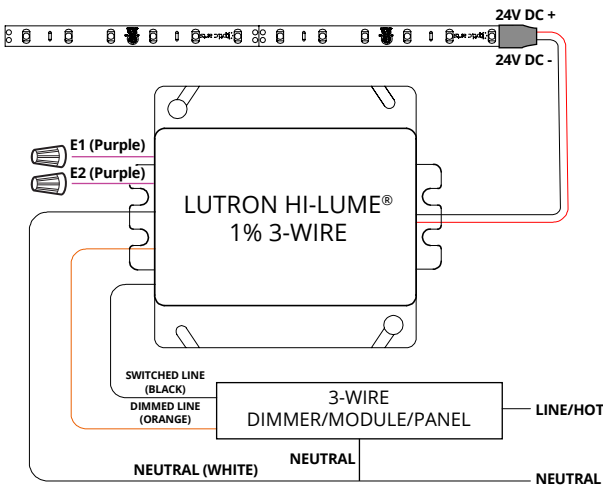

ECOSYSTEM

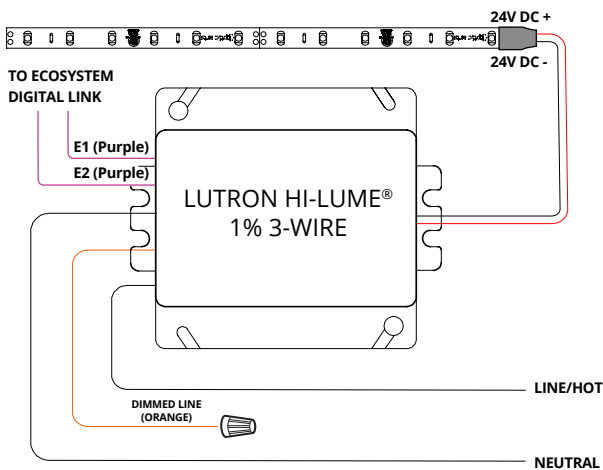

LUTRON HI-LUME® 1%: 3-WIRE/ECOSYSTEM



PART	DESCRIPTION
L3DA4U1UKL-CV240	5-40W, 120-277VAC, 3-WIRE/ECOSYSTEM DRIVER

DIMENSIONS	
HI-LUME® 1%	H 4.00"; W 4.89"; D 2.62"

DIMMING PERFORMANCE	
LUTRON HI-LUME® 1% 3-WIRE/ ECOSYSTEM	Dims to 1% with compatible Lutron controls

COMPATIBLE DRIVERS

3-WIRE

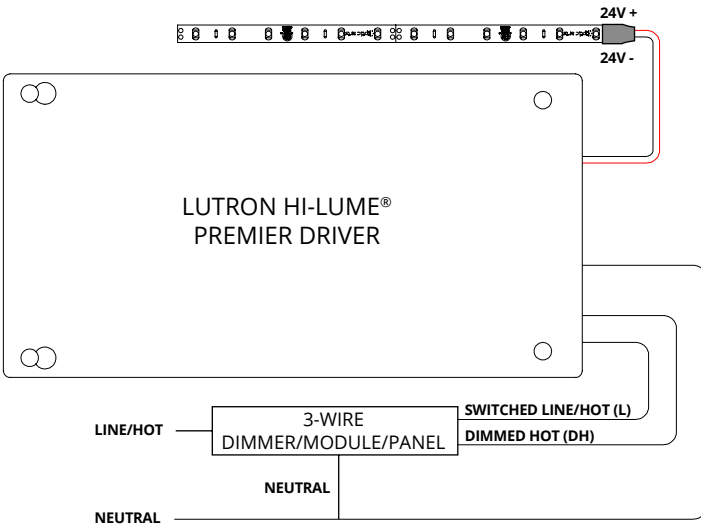

ECOSYSTEM

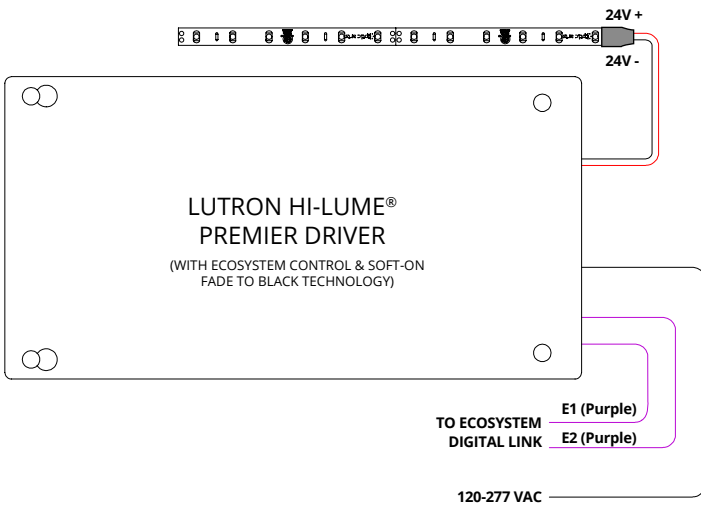

LUTRON HI-LUME® PREMIER: 3-WIRE/ECOSYSTEM



PART	DESCRIPTION
L3D0-96W24V-U	2-96W, 120-277VAC, 3-WIRE/ECOSYSTEM DRIVER

DIMENSIONS	
HI-LUME® PREMIER	H 5.5"; W 10.5"; D 2.0"

DIMMING PERFORMANCE	
LUTRON HI-LUME® PREMIER	Dims to 0.1% with compatible Lutron controls
<i>NOTE: Lutron soft-on, fade to black technology available with Ecosystem Digital Control only.</i>	