



FLEX DC® 88 is a high performance flexible LED fixture suitable for use in coves, under cabinets, in shelves, and virtually anywhere a linear fixture is required.

ELECTRICAL

| | |
|--------------------------|--|
| Input Voltage | 24VDC |
| Dimming Options | <ul style="list-style-type: none"> • PURE DC™ • MLV • 0-10 Volts • DMX • Lutron (2-WIRE, 3-WIRE, EcoSystem) |
| Power Consumption | 8.8 Watts per foot |
| Wire Size | 18AWG, 2 wire |
| Certification | ETL - Conforms to UL Std. 2108; Certified to CSA Std. C22.2 No. 9.0 Title 24 - Selected models are JA8 2016 compliant when used with 0-10V, DMX, Lutron A-Series 2-Wire or Lutron Premier dimming. JA8 option must be specified in part number builder below. |

PHYSICAL

| | |
|-----------------------------------|--|
| Field Cuttable | Every 1.97" |
| Operating Temperature | -40° C (-40°F) to +70°C (+158°F) |
| Environment | IP40 - Dry Location IP68 - Wet Location |
| Maximum Class 2 Run Length | IP40: 10', IP68: 10' |
| Dimensions (W x H): | IP40 - 0.63" (15.88mm) x 0.13" (3.18mm) IP68 - 0.69" (17.47mm) x 0.25" (6.35mm) IP68 Endcaps - 0.33" (8.40mm) x 0.77" (30.17mm) |

ACCESSORIES

| | |
|-------------------|--|
| Channels | Optic Arts® Channel (pg. 3-5) |
| Connectors | LC-I2P-M, LC-I2P-F, LC-O2P-F, LC-O2P-M (Pg. 5) |

Note: FLEX DC® 88 must be used in conjunction with Optic Arts® Channel for proper heat dissipation.

LUMEN OUTPUT

| | |
|---------------------------|----------------------------|
| 2000K (IP40 only) | 465.74 lm/ft 54.51 lm/Watt |
| 2400K ¹ | 649.50 lm/ft 73.81 lm/Watt |
| 2700K ¹ | 762.08 lm/ft 86.60 lm/Watt |
| 3000K ¹ | 783.55 lm/ft 89.04 lm/Watt |
| 3500K ¹ | 840.31 lm/ft 95.49 lm/Watt |
| 4100K ¹ | 813.12 lm/ft 92.40 lm/Watt |
| 6000K ¹ | 838.20 lm/ft 95.25 lm/Watt |

Note: Stated lumen values have a tolerance of +/- 10%.

1: Offered in JA8 when used with 0-10V, DMX, Lutron A-Series 2-Wire or Lutron Premier dimming (IP40).

PERFORMANCE

| | |
|--------------------------|--------------|
| CRI | 90+ |
| Lumen Maintenance | 50,000 Hours |
| Binning Tolerance | +/- 100K |
| Warranty | 5 years |

PART NUMBER BUILDER

| SERIES | IP RATING | COLOR | VOLTAGE | WATTAGE | CONFIGURATION | LENGTH | JA8 |
|--------|--|--|-------------|-----------|--|--------------------|-------------------|
| FLEXDC | 40 = IP40 - Dry Location 68 = IP68 - Wet Location | 20 = 2000K (IP40 only) 24 = 2400K ¹ 27 = 2700K ¹ 30 = 3000K ¹ 35 = 3500K ¹ 41 = 4100K ¹ 60 = 6000K ¹ | 24 = 24 VDC | 88 = 8.8W | FLC1 = FLEX Config 1 FLC2 = FLEX Config 2 FLC3 = FLEX Config 3 | XX = Custom Length | Y = Yes N = No |

1: Offered in JA8 when used with 0-10V, DMX, Lutron A-Series 2-Wire or Lutron Premier dimming (IP40).

DIMENSIONS

Optic Arts® cuts all FLEX DC® and Channel products to length per customer specifications. Each length of FLEX DC® is fitted with a 6' wire lead (custom lengths available upon request) and packaged on a reel in an anti-static bag. Bags are labeled with fixture type, length and location (if applicable). Each piece of channel is labeled with fixture type, length and location (if applicable), and is bundled by fixture type.

- Due to the nature of the FLEX DC® product, specific lengths may not fall exactly on a cutting point. In this case, Optic Arts® will always cut to the smaller dimension unless otherwise specified.
- Unless otherwise specified, channel is cut 15mm longer than FLEX DC®.
- Some on-site assembly required. See installation guides for details.

INDOOR FLEX DC® 88

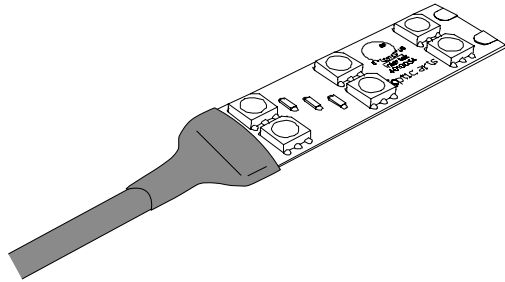
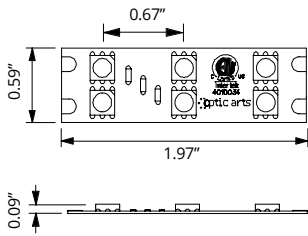

INDOOR DIMENSIONS

| | |
|-------------------------|--------------------|
| Width | 0.59" (15.88mm) |
| Height | 0.09" (2.21mm) |
| Cuttable Segment Length | 1.97" (50.04mm) |
| Pitch Length | 0.67" (17.47mm) |
| Max Run Length | 10.00' (3048.00mm) |

OUTDOOR FLEX DC® 88

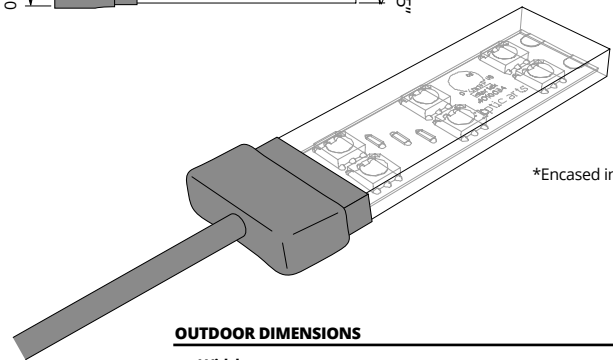
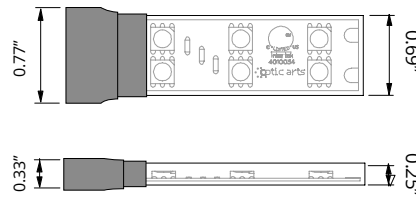

*Encased in silicon

OUTDOOR DIMENSIONS

| | |
|-----------------|--------------------|
| Width | 0.69" (17.47mm) |
| Height | 0.25" (6.35mm) |
| Width (Endcap) | 0.77" (19.54mm) |
| Height (Endcap) | 0.33" (8.40mm) |
| Max Run Length | 10.00' (3048.00mm) |

INDOOR FLEX DC® 88

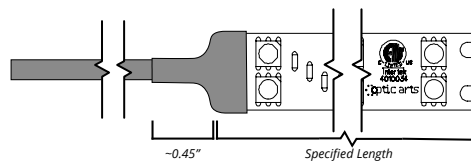

OUTDOOR FLEX DC® 88

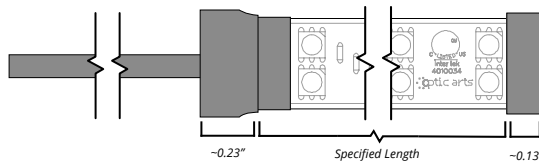

MOUNTING OPTIONS - COMPATIBLE CHANNELS

[Click to access CHANNEL ACCESSORIES CATALOGUE >](#)

KEY

DIFFUSION LEVEL:

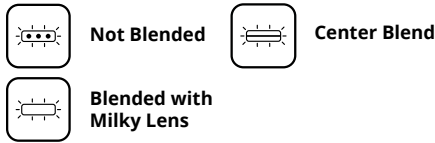

CONFIGURATION:

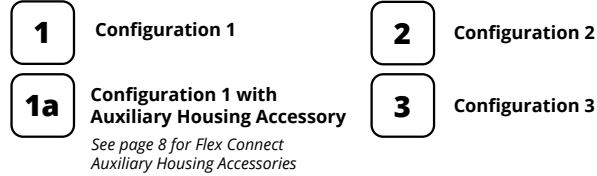

CHS-R-1208

• Click on channel titles below to access complete channel cut sheets.

MEDIUM CHANNELS

MEDIUM CHANNEL PART NUMBER BREAKDOWN:

| CHANNEL | CHANNEL SIZE | CHANNEL TYPE | FINISH | LENS TYPE | LENS DIFFUSION | MOUNTING |
|------------------------|---|--|--|-----------|--|--|
| CH-MD = Channel Medium | LS = Legacy Short TL = Tall ⁶ | SF = Surface RE = Recessed ⁴ | SS = Satin Silver MB = Matte Black Anodized ⁹ BZ = Deep Bronze Anodized ⁹ WH = White Powder Coat ⁹ GY = Gray Powder Coat ⁹ | FL = Flat | CC = Clear CF = Frosted CM = Milky | NA = Direct Surface MC = Mounting Clip ⁷ RC = Rotating Clip ⁷ PD = Pendant ^{7,8} |

4: Not available for tall channel.

5: Only available in surface channel type.

7: Not compatible with recessed options.

8: Not available with Lite option.

9: Special order finishes may increase order lead time and incur an added cost.

CH-MD-LS-SF

(Previously Known As CHW-S-2010)

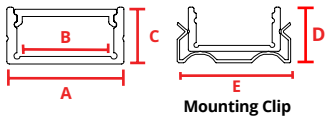

Mounting Clip

A: 0.93" (23.50mm) **D:** 0.48" (12.19mm)
B: 0.78" (20.00mm) **E:** 1.02" (25.80mm)
C: 0.39" (10.00mm)



MATERIAL

Anodized Aluminum

DESCRIPTION

Medium - Lite - Surface - Channel.



LENGTH

7 Ft.



LENS TYPES

Clear CH-MD-LN-FL-CC
 Frosted CH-MD-LN-FL-CF
 Milky CH-MD-LN-FL-CM



ACCESSORIES

Endcap CH-MD-LS-SF-FL-EC
 Endcap w/hole CH-MD-LS-SF-FL-ECH
 Mounting Clip CH-MD-LE-MC
 Rotating Mounting Clip CH-MD-LE-MC-R

CH-MD-LS-RE

(Previously Known As CHW-R-2010)

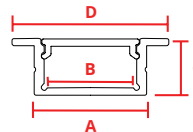

A: 0.93" (23.50mm)
B: 0.78" (20.00mm)
C: 0.39" (10.00mm)
D: 1.19" (30.24mm)



MATERIAL

Anodized Aluminum

DESCRIPTION

Medium - Lite - Recessed - Channel.



LENGTH

7 Ft.



LENS TYPES

Clear CH-MD-LN-FL-CC
 Frosted CH-MD-LN-FL-CF
 Milky CH-MD-LN-FL-CM

ACCESSORIES

Endcap CH-MD-LS-RE-FL-EC
 Endcap w/hole CH-MD-LS-RE-FL-ECH
 Mounting Clip CH-MD-LE-MC
 Rotating Mounting Clip CH-MD-LE-MC-R

CH-MD-TL-SF

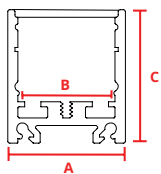

A: 0.90" (23.11mm)
B: 0.75" (19.05mm)
C: 1.02" (26.16mm)



MATERIAL

Anodized Aluminum

DESCRIPTION

Medium - Tall - Surface - Channel.



LENGTH

7 Ft.



LENS TYPES

Clear CH-MD-LN-FL-CC
 Frosted CH-MD-LN-FL-CF
 Milky CH-MD-LN-FL-CM



ACCESSORIES

Endcap CH-MD-TL-SF-FL-EC
 Endcap w/hole CH-MD-TL-SF-FL-ECH
 Mounting Clip CH-MC
 Rotating Mounting Clip CH-MC-R-AY
 Pendant CH-PD-KIT

MOUNTING OPTIONS - COMPATIBLE CHANNELS

- Not Blended
 Blended w/Milky Lens
 1 Configuration 1
 1a Configuration 1 with Auxiliary Housing Accessory
 2 Configuration 2
 3 Configuration 3

CORNER CHANNELS

CHW-C-3030S

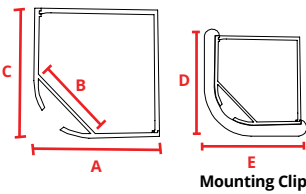

| | |
|----------|--|
| | MATERIAL Anodized Aluminum |
| 1 | DESCRIPTION 45 degree channel with square lens. |
| 2 | LENGTH 2 meter |
| 3 | LENS TYPES Clear CHW-C-3030S-CC Frosted CHW-C-3030S-CF Milky CHW-C-3030S-CM |
| | ACCESSORIES Endcap CHW-C-3030S-EC Endcap w/hole CHW-C-3030S-ECH Mounting Clip CHW-C-3030S-MC |

A: 1.18" (30.00mm) **D:** 1.29" (32.77mm)
B: 0.78" (20.20mm) **E:** 1.29" (32.77mm)
C: 1.18" (30.00mm)

CHW-C-3030

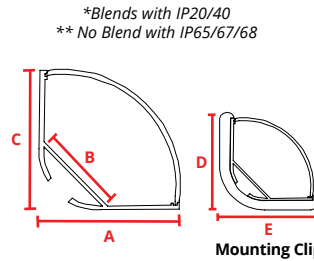

| | |
|----------|---|
| | MATERIAL Anodized Aluminum |
| 1 | DESCRIPTION 45 degree channel with rounded lens. |
| 2 | LENGTH 2 meter |
| 3 | LENS TYPES Clear CHW-C-3030-CC Frosted CHW-C-3030-CF Milky CHW-C-3030-CM |
| | ACCESSORIES Endcap CHW-C-3030-EC Endcap w/hole CHW-C-3030-ECH Mounting Clip CHW-C-3030-MC |

A: 1.18" (30.00mm) **D:** 1.29" (32.77mm)
B: 0.78" (20.20mm) **E:** 1.29" (32.77mm)
C: 1.18" (30.00mm)

SPECIALTY CHANNELS

CHS-S-1922R

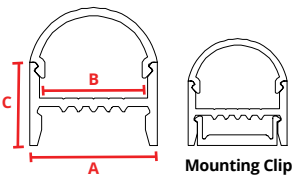

| | |
|----------|---|
| | MATERIAL Anodized Aluminum |
| 1 | DESCRIPTION Slim surface mounted channel with rounded wrap around lens. Mounting clip is fully concealed within fixture base. |
| 2 | LENGTH 2 meter |
| 3 | LENS TYPES Milky CHW-S-1922R-CM |
| | ACCESSORIES Endcap CHS-S-1922R-EC Endcap w/hole CHS-S-1922R-ECH Mounting Clip CHS-S-1922R-MC |

A: 0.77" (19.50mm)
B: 0.65" (16.50mm)
C: 0.86" (21.80mm)

CHS-S-1922S

Fits IP40 FLEX DC® Only

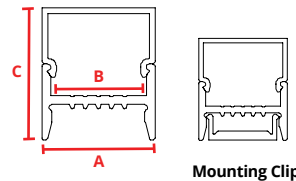

| | |
|----------|--|
| | MATERIAL Anodized Aluminum |
| 1 | DESCRIPTION Slim surface mounted channel with square wrap around lens. Mounting clip is fully concealed within fixture base. |
| 2 | LENGTH 2 meter |
| 3 | LENS TYPES Milky CHW-S-1922S-CM |
| | ACCESSORIES Endcap CHS-S-1922S-EC Endcap w/hole CHS-S-1922S-ECH Mounting Clip CHS-S-1922S-MC |

A: 0.77" (19.50mm)
B: 0.65" (16.50mm)
C: 0.86" (21.80mm)

CHW-S-2623

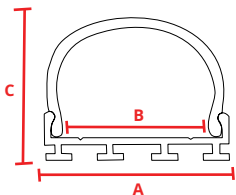

| | |
|----------|--|
| | MATERIAL Anodized Aluminum |
| 1 | DESCRIPTION Surface mounted channel with wrap around lens. |
| 2 | LENGTH 2 meter |
| | LENS TYPES Milky CHW-S-2623-CM |
| | ACCESSORIES Endcap CHW-S-2623-EC Endcap w/hole CHW-S-2623-ECH |

A: 1.03" (26.20mm)
B: 0.80" (20.35mm)
C: 0.89" (22.76mm)

CHW-S/H-3561

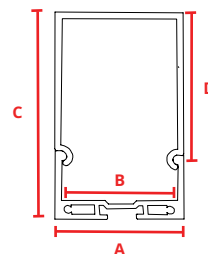

| | |
|----------|---|
| | MATERIAL Anodized Aluminum |
| 1 | DESCRIPTION Large surface mounted or hanging channel with wrap around lens. |
| 2 | LENGTH 2 meter |
| | LENS TYPES Milky CHW-SH-3561-CM |
| | ACCESSORIES Endcap CHW-SH-3561-EC End Cap w/hole CHW-SH-3561-ECH Hanging Hardware CHW-SH-MW Bracket Straight CHW-SH-SB Bracket 90° Flat CHW-SH-B90F Bracket 90° Raised CHW-SH-B90R |

A: 1.38" (35.00mm) **C:** 2.43" (61.70mm)
B: 1.24" (31.40mm) **D:** 1.57" (39.90mm)

**Must specify for hanging or surface mount application.*

MOUNTING OPTIONS - COMPATIBLE CHANNELS

- Not Blended
 Blended w/Milky Lens
 1 Configuration 1
 1a Configuration 1 with Auxiliary Housing Accessory
 2 Configuration 2
 3 Configuration 3

SPECIALTY CHANNELS

CHW-S/H-3030

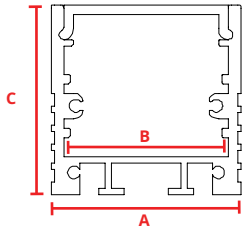

- A:** 1.18" (30.00mm)
- B:** 1.01" (25.60mm)
- C:** 1.18" (30.00mm)

*Must specify for hanging or surface mount application.



MATERIAL
Anodized Aluminum



DESCRIPTION
Wide and deep surface mounted or hanging channel with flat lens for even blending.



LENGTH
2 meter



LENS TYPES
Milky CHW-SH-3030-CM

ACCESSORIES

| | |
|---------------------------|------------------|
| Endcap | CHW-SH-3030-EC |
| Endcap w/hole | CHW-SH-3030-ECH |
| Hanging Hardware | CHW-SH-MW |
| Bracket Straight | CHW-SH-BS |
| Bracket 90° Flat | CHW-SH-B90F |
| Bracket 90° Raised | CHW-SH-B90R |
| End Cap for FLEX AC | CHW-SH-3030-ECAC |
| Mounting Clip for FLEX AC | CHW-SH-3030-MCAC |
| VHB Tape | VHBTAPE.AC |

CHW-S/H-2027

Fits IP40 FLEX DC® Only

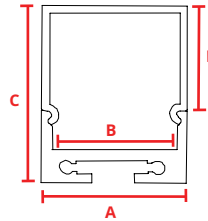

- A:** 0.79" (20.30mm)
- B:** 0.66" (16.70mm)
- C:** 1.06" (27.00mm)
- D:** 0.76" (19.50mm)

*Must specify for hanging or surface mount application.



MATERIAL
Anodized Aluminum



DESCRIPTION
Small surfaced mounted or hanging channel with wrap around lens.



LENGTH
2 meter



LENS TYPES

| | |
|---------|----------------|
| Clear | CHW-SH-2027-CC |
| Frosted | CHW-SH-2027-CF |
| Milky | CHW-SH-2027-CM |

ACCESSORIES

| | |
|--------------------|-----------------|
| Endcap | CHW-SH-2027-EC |
| End Cap w/hole | CHW-SH-2027-ECH |
| Hanging Hardware | CHW-SH-MW |
| Bracket Straight | CHW-SH-BS |
| Bracket 90° Flat | CHW-SH-B90F |
| Bracket 90° Raised | CHW-SH-B90R |

CHW-S-3535

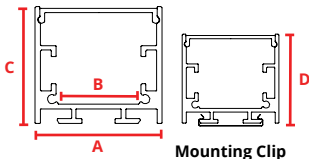

- A:** 1.39" (35.25mm)
- B:** 0.96" (24.50mm)
- C:** 1.39" (35.25mm)
- D:** 1.54" (39.00mm)

*Must specify for hanging or surface mount application.



MATERIAL
Anodized Aluminum



DESCRIPTION
Wide and deep surface mounted or hanging channel. Eliminates visible LED nodes for most FLEXDC products when used with a milky lens.



LENGTH
2 meter



LENS TYPES
Frosted CHW-35mm-CF
Milky CHW-35mm-CM

ACCESSORIES

| | |
|---------------------------|-----------------|
| Endcap | CHW-S-3535-EC |
| Endcap w/hole | CHW-S-3535-ECH |
| Mounting Clip | CHW-S-3535-MC |
| Hanging Hardware | CHW-SH-3535-MW |
| Bracket Straight | CHW-S-XX35-BS |
| Bracket 90° Flat | CHW-S-XX35-B90F |
| Bracket 90° Raised | CHW-S-XX35-B90R |
| End Cap for FLEX AC | CHW-S-3535-ECAC |
| Mounting Clip for FLEX AC | CHW-S-3535-MCAC |
| VHB Tape | VHBTAPE.AC |

CHW-R-4435

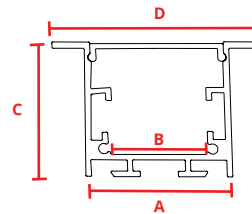

- A:** 1.39" (35.25mm)
- B:** 0.96" (24.50mm)
- C:** 1.39" (35.25mm)
- D:** 2.00" (51.04mm)

DESCRIPTION
Wide and deep recessed channel. Eliminates visible LED nodes for most FLEXDC products when used with a milky lens. Can be securely and conveniently mounted with CHW-R-4435-SC spring clip.

LENS TYPES
Frosted CHW-35mm-CF
Milky CHW-35mm-CM

ACCESSORIES

| | |
|---------------------------|-----------------|
| Endcap | CHW-R-4435-EC |
| Endcap w/hole | CHW-R-4435-ECH |
| Mounting Clip | CHW-R-4435-SC |
| Bracket Straight | CHW-S-XX35-BS |
| Bracket 90° Flat | CHW-S-XX35-B90F |
| Bracket 90° Raised | CHW-S-XX35-B90R |
| End Cap for FLEX AC | CHW-R-4435-ECAC |
| Mounting Clip for FLEX AC | CHW-R-4435-MCAC |
| VHB Tape | VHBTAPE.AC |

CHW-S/H-7532

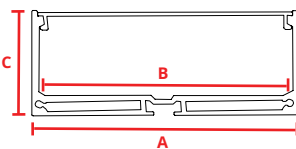

- A:** 2.95" (75.00mm)
- B:** 2.52" (64.00mm)
- C:** 1.26" (32.00mm)

*Must specify for hanging or surface mount application.



MATERIAL
Anodized Aluminum



DESCRIPTION
Wide surface mounted or hanging channel with flat lens.



LENGTH
2 meter



LENS TYPES
Frosted CHW-SH-7532-CF

ACCESSORIES

| | |
|--------------------|-----------------|
| Endcap | CHW-SH-7532-EC |
| Endcap w/hole | CHW-SH-7532-ECH |
| Hanging Hardware | CHW-SH-MW |
| Bracket Straight | CHW-SH-BS |
| Bracket 90° Flat | CHW-SH-B90F |
| Bracket 90° Raised | CHW-SH-B90R |

ACCESSORIES

LC-I2P-M

Indoor Lead Connector
(Male)

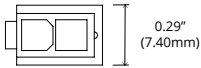
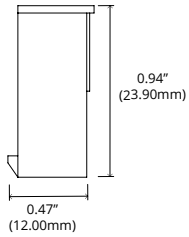
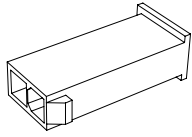

LC-I2P-F

Indoor Lead Connector
(Female)

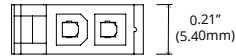
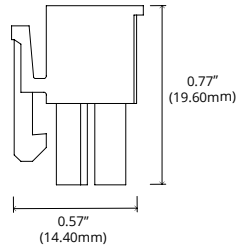
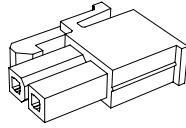

LC-O2P-F

Outdoor Lead Connector
(Female)

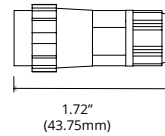
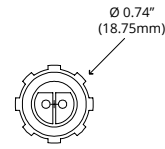
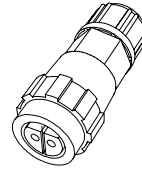

LC-O2P-M

Outdoor Lead Connector
(Male)

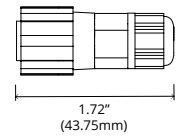
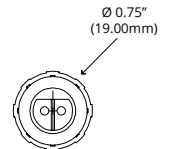
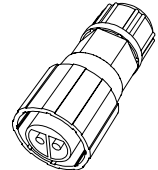

FLEX.ZIP

Strain Relief Clip

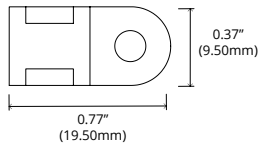
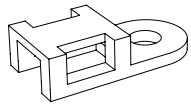

CONFIGURATION TYPES

1 [NOT COMPATIBLE] FLEX cut to length with FLEX Connect® Power Feeds for Field Termination, Channel uncut for field cutting

- Specify **FLEXConfig-1**
 - Specify FLEX type and channel type
 - FLEX factory cut to length, but not terminated
 - One FLEX Connect® power feed connector and 6' lead provided per FLEX run
 - Uncut rolls of lead wire can also be provided (see page 8 for part #)
 - Channel shipped uncut for field cutting.
 - Specify number of butt splices (not shown - see page 8)
 - IP68 not available in **FLEXConfig-1**
 - JA8 2016 not available in **FLEXConfig-1**
 - FLEXConfig-1** is quick ship if run lengths are provided at time of order. Take offs, if needed, will add lead time.
- The below channels are **NOT** compatible with FLEX Connect®:

- Slim:**
- CHS-R-1208
 - CHS-R-1715
 - CHS-C-1616
 - CHC-S-1921
- Specialty:**
- CHSP-R-2970
 - CHSP-S-1618
 - CHSP-STEP-8142

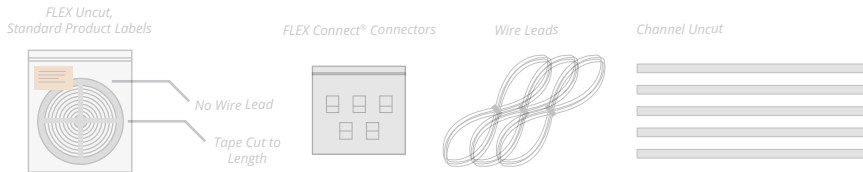

2 Cut To Length With Soldered Leads, Assemble On-Site^{1,2,3}

- Specify **FLEXConfig-2**
- Specify FLEX type and channel type
- Specify run lengths
- IP68 only available in **FLEXConfig-2**
- If no config is specified, and run lengths are provided, **FLEXConfig-2** will be used

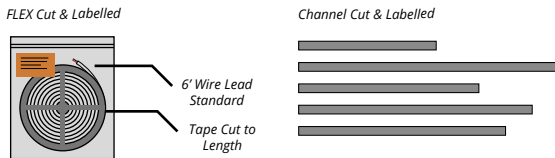

3 Pre-Assembled Factory Finished Fixtures^{1,2}

- Specify **FLEXConfig-3**
- Fully assembled fixture
- ETL stamped and listed as a fixture
- 6.50' max length
- Standard 6' power lead unless otherwise specified
- The below channels **CANNOT** be factory assembled:

- Slim:**
- CHS-R-1208
 - CHS-R-1715
- Wide:**
- CHW-R-2010
 - CHW-S-2027
 - CHW-S-7532
 - CHW-S-2623
 - CHW-S-3030
 - CHW-S-3561

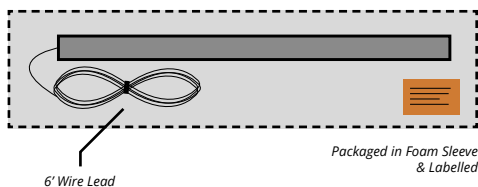

NOTES:

- Due to the nature of the FLEX DC® product, specific lengths may not fall exactly on a cutting point. In this case, Optic Arts® will always cut to the smaller dimension unless otherwise specified.
- Unless otherwise specified, channel is cut 15mm longer than FLEX DC®.
- Some on-site assembly required. See installation guides for details.

COMPATIBLE DRIVERS

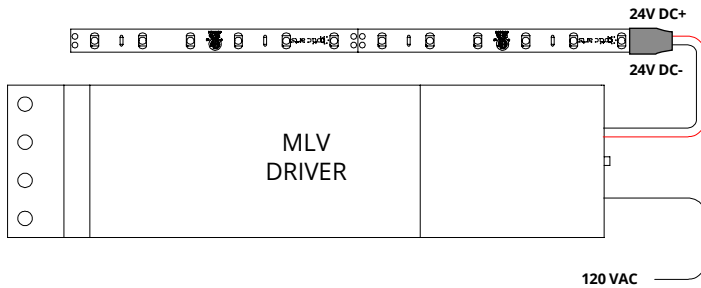

MLV (MLV)

| PART | DESCRIPTION |
|------------------|---|
| ML10S24VDC | 10W 120VAC DIMMABLE DRIVER |
| ML20S24VDC | 20W 120VAC DIMMABLE DRIVER |
| ML35S24VDC | 35W 120VAC DIMMABLE DRIVER |
| ML35S24VDC-277 | 35W 277VAC DIMMABLE DRIVER |
| ML40S24VDC | 40W 120VAC DIMMABLE DRIVER |
| ML50S24VDC | 50W 120VAC DIMMABLE DRIVER |
| ML50S24VDC-277 | 50W 277VAC DIMMABLE DRIVER |
| ML60S24VDC | 60W 120VAC DIMMABLE DRIVER |
| ML75S24VDC | 75W 120VAC DIMMABLE DRIVER |
| ML75S24VDC-277 | 75W 277VAC DIMMABLE DRIVER |
| ML96S24VDC | 96W 120VAC DIMMABLE DRIVER |
| ML96S24VDC-277 | 96W 120VAC DIMMABLE DRIVER |
| EM2-200S24DC | 200W 120VAC DIMMABLE DRIVER, 2 96W CIRCUITS |
| EM3-300S24DC | 300W 120VAC DIMMABLE DRIVER, 3 96W CIRCUITS |
| EM2-200S24DC-277 | 200W 120VAC DIMMABLE DRIVER, 2 96W CIRCUITS |
| EM3-300S24DC-277 | 288W 120VAC DIMMABLE DRIVER, 3 96W CIRCUITS |

DIMENSIONS

| | |
|----------|----------------------------|
| 10W-50W | H 2.11"; W 7.38"; D 1.60" |
| 60W-96W | H 3.93"; W 8.13"; D 1.59" |
| 200-300W | H 5.69"; W 10.29"; D 3.13" |

DIMMING PERFORMANCE

| | |
|------------|---------------------------------|
| MLV DRIVER | Dims to 20% on most MLV dimmers |
|------------|---------------------------------|

NOTE: Must be loaded between 75%-100% of rated load to maintain FLEX DC® warranty

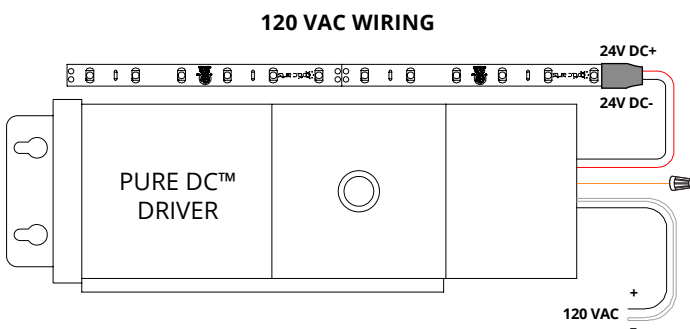

PURE DC™ MLV (PDC)

| PART | DESCRIPTION |
|-----------|---|
| PDC.40.24 | 40W 120/277VAC PURE DC™ MLV DIMMABLE DRIVER |
| PDC.96.24 | 96W 120/277VAC PURE DC™ MLV DIMMABLE DRIVER |

DIMENSIONS

| | |
|-----|----------------------------|
| 40W | L 14.25"; W 3.00"; H 2.88" |
| 96W | L 14.75"; W 4.31"; H 4.81" |

DIMMING PERFORMANCE

| | |
|-----------------|----------------------------------|
| PURE DC™ DRIVER | Dims to 0.1% on most MLV dimmers |
|-----------------|----------------------------------|

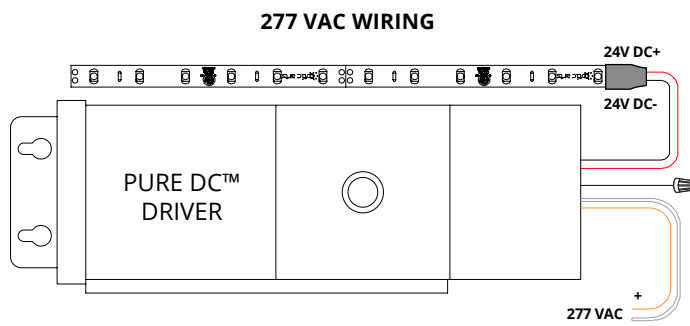

COMPATIBLE DRIVERS

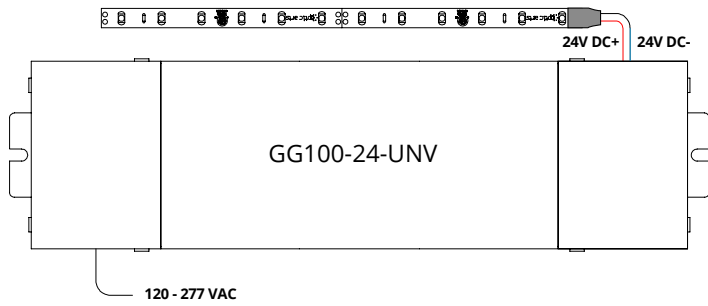

ELECTRONIC DRIVER - NON-DIM (ND)

| PART | DESCRIPTION |
|----------------------------|----------------------------------|
| GG100E-24-UNV | 96W 120-277VAC ELECTRONIC DRIVER |
| DIMENSIONS | |
| ELECTRONIC DRIVER | H 3.00"; W 11.46"; D 1.30" |
| DIMMING PERFORMANCE | |
| ELECTRONIC DRIVER | Non-Dim |

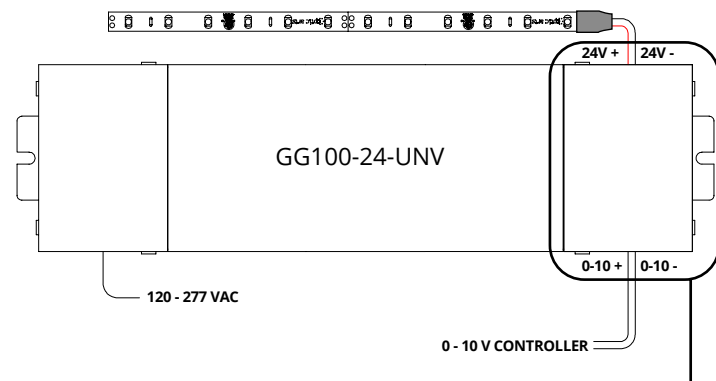

ELECTRONIC DRIVER W/0-10V MODULE (010)

| PART | DESCRIPTION |
|----------------------------|---|
| GG100E-24-UNV-010V | 96W 120-277VAC ELECTRONIC DRIVER WITH 0-10V DIMMING MODULE (SINK) |
| DIMENSIONS | |
| ELECTRONIC DRIVER - 0-10V | H 3.00"; W 11.46"; D 1.30" |
| DIMMING PERFORMANCE | |
| ELECTRONIC DRIVER - 0-10V | Dims below 1% on most 0-10V dimmers |

FIELD INSTALLED IN LOW VOLTAGE WIRING COMPARTMENT

- Install DIM-010V Module in low voltage wiring compartment.
- Max number of 25 modules on one dimmer. Consult dimmer datasheet for maximum device limitation of a specific controller.



COMPATIBLE DRIVERS

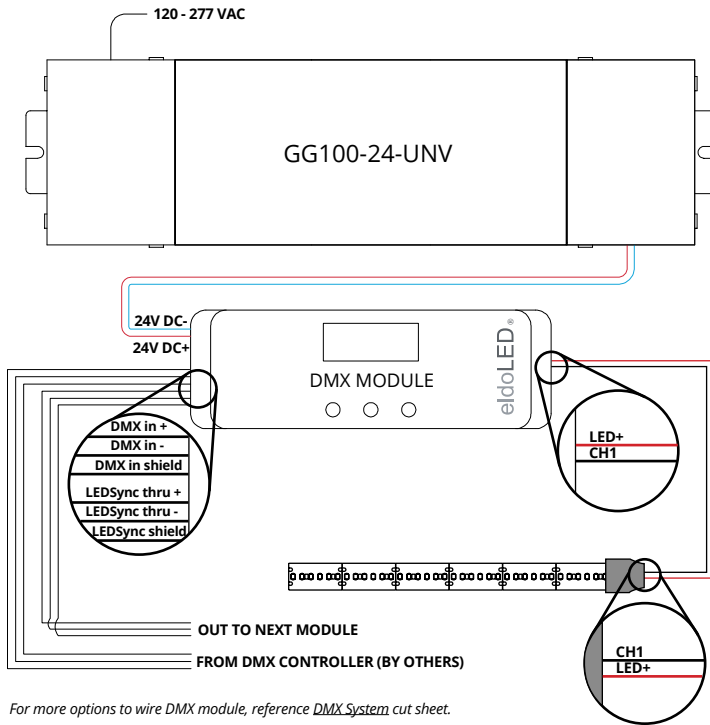

ELECTRONIC DRIVER W/DMX MODULE (DMX)

| PART | DESCRIPTION |
|-------------------|--|
| GG100E-24-UNV-DMX | 96W 120-277VAC ELECTRONIC DRIVER WITH eldoLED DMX DIMMING MODULE |

| DIMENSIONS | |
|------------|----------------------------|
| 96W | H 3.00"; W 11.46"; D 1.30" |
| DMX MODULE | H 1.97"; W 6.02"; D 0.91" |

*Must be installed in UL box (by others)

| DIMMING PERFORMANCE | |
|--------------------------------|----------------------------------|
| ELECTRONIC DRIVER - DMX MODULE | Dims to 0.1% on most DMX systems |

COMPATIBLE DRIVERS

DIMMER WITH NEUTRAL

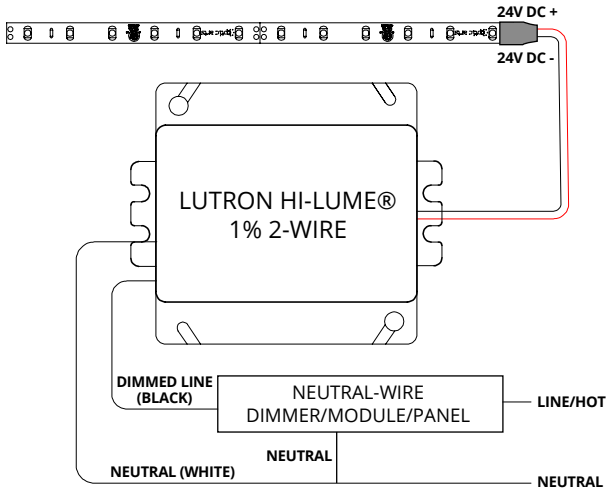

DIMMER WITHOUT NEUTRAL

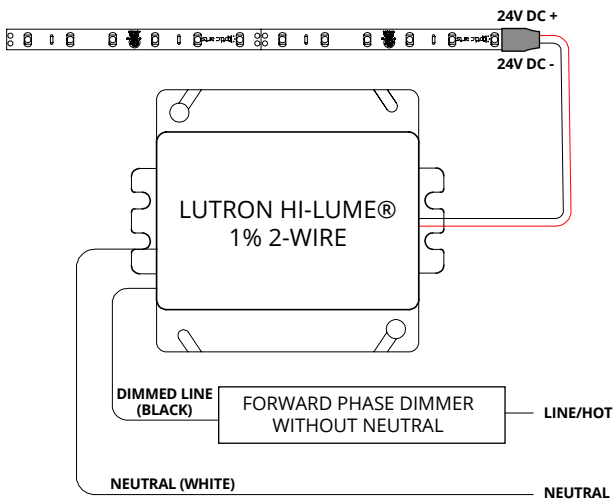

LUTRON HI-LUME® 1% 2-WIRE: 2-WIRE CONTROL FORWARD PHASE



| PART | DESCRIPTION |
|----------------------------|--|
| LTEA4U1UKL-CV240 | 5-40W, 120VAC, 2-WIRE FORWARD PHASE DRIVER |
| DIMENSIONS | |
| HI-LUME® 1% 2-WIRE | H 4.00"; W 4.89"; D 2.62" |
| DIMMING PERFORMANCE | |
| LUTRON HI-LUME® 1% 2-WIRE | Dims to 1% with compatible Lutron controls |

COMPATIBLE DRIVERS

3-WIRE

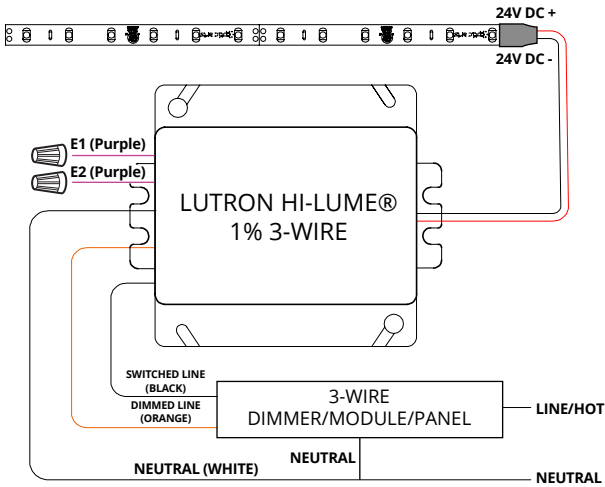

ECOSYSTEM

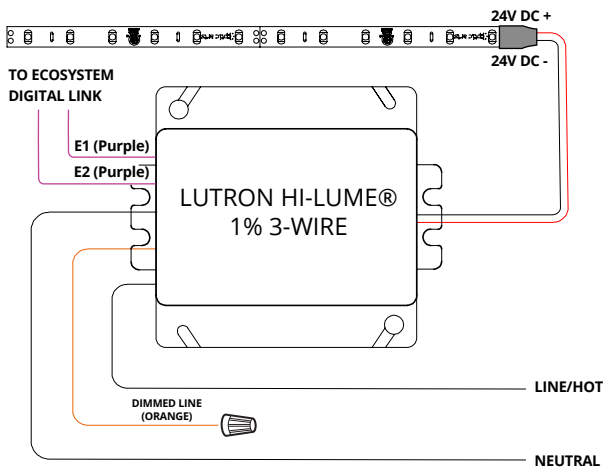

LUTRON HI-LUME® 1%: 3-WIRE/ECOSYSTEM



| PART | DESCRIPTION |
|------------------|--|
| L3DA4U1UKL-CV240 | 5-40W, 120-277VAC, 3-WIRE/ECOSYSTEM DRIVER |

| DIMENSIONS | |
|-------------|---------------------------|
| HI-LUME® 1% | H 4.00"; W 4.89"; D 2.62" |

| DIMMING PERFORMANCE | |
|--|--|
| LUTRON HI-LUME® 1% 3-WIRE/ECOSYSTEM | Dims to 1% with compatible Lutron controls |

COMPATIBLE DRIVERS

3-WIRE

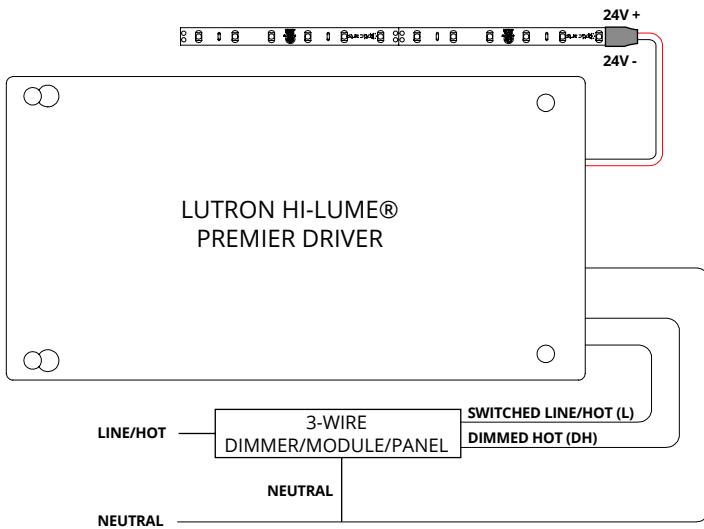

ECOSYSTEM

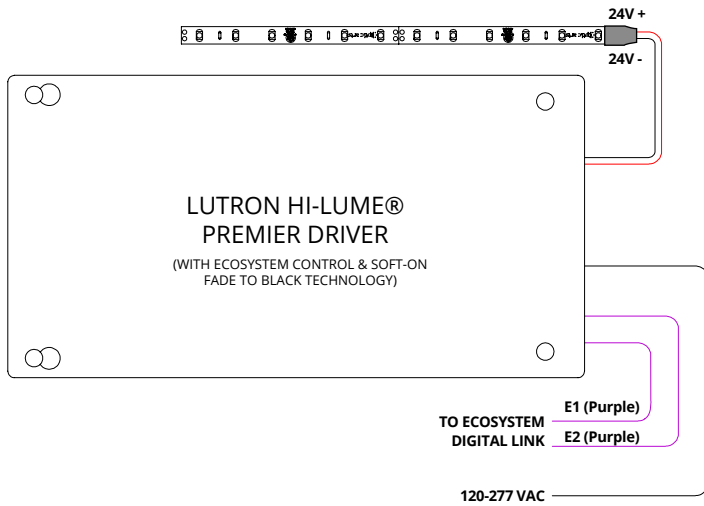

LUTRON HI-LUME® PREMIER: 3-WIRE/ECOSYSTEM



| PART | DESCRIPTION |
|---------------|--|
| L3D0-96W24V-U | 2-96W, 120-277VAC, 3-WIRE/ECOSYSTEM DRIVER |

| DIMENSIONS | |
|------------------|-------------------------|
| HI-LUME® PREMIER | H 5.5"; W 10.5"; D 2.0" |

| DIMMING PERFORMANCE | |
|--|--|
| LUTRON HI-LUME® PREMIER | Dims to 0.1% with compatible Lutron controls |
| <i>NOTE: Lutron soft-on, fade to black technology available with Ecosystem Digital Control only.</i> | |