

It is well established that traditional forms of artificial light can disrupt sea turtle hatching patterns and disorient hatchlings. Our **FWC (Florida Wildlife Commission) certified luminaires** feature carefully crafted 590nm LEDs that, when used in conjunction with proper shielding, can help create a safer space for sea turtles and other wildlife.



Product Image



Example Application

### FEATURES:

- IP68 rated for Wet Location
- 39.58 lm/ft; 26.39 lm/Watt
- Approved for use in proximity to wildlife
- Carefully crafted 590nm LEDs

### SUGGESTED APPLICATIONS:

- Handrail
- Surface Mount
- Recessed
- Cove
- Corner

### PART NUMBER BUILDER

SERIES	+	IP RATING	+	COLOR	+	VOLTAGE	+	WATTAGE	+	LENGTH
FLEXDC		68 = IP68 - Wet Location		A = Amber		24 = 24 VDC		15 = 1.5W		XX = Custom Length

## TECHNICAL

### ELECTRICAL

<b>Input Voltage</b>	24VDC
<b>Dimming Options</b>	<ul style="list-style-type: none"> <li>• PURE DC™</li> <li>• MLV</li> <li>• 0-10V</li> <li>• DMX</li> <li>• Lutron (2-WIRE, 3-WIRE, EcoSystem)</li> </ul>
<b>Power Consumption</b>	1.5 Watts per foot (18 LEDs per foot)
<b>Wire Size</b>	18AWG, 2 wire
<b>Certification</b>	<b>ETL</b> - Conforms to UL Std. 2108; Certified to CSA Std. C22.2 No. 9.0. <b>FWC Wildlife Lighting (#2018-023)</b> - Approved for use in proximity to wildlife.

### PHYSICAL

<b>Field Cuttable</b>	Every 3.94"
<b>Operating Temperature</b>	-40° C (-40°F) to +70°C (+158°F)
<b>Environment</b>	<b>IP68</b> - Wet Location
<b>Maximum Run Length</b>	64'
<b>Dimensions (WxH)</b>	0.42" (10.55mm) x 0.19" (4.80mm)
	<b>Endcaps</b> - 0.50" (12.70mm) x 0.31" (7.87mm)

### ACCESSORIES

<b>Mounting Clips</b>	FLEXMNT.SIL.EXT12 (pg. 7)
<b>Channels</b>	Optic Arts® Channel (pg. 3-6)
<b>Connectors</b>	LC-O2P-F, LC-O2P-M (pg. 7)

### LUMEN OUTPUT

<b>Amber</b>	39.58 lm/ft 26.39 lm/Watt
<i>Note: Stated lumen values have a tolerance of +/- 10%.</i>	

### PERFORMANCE

<b>Lumen Maintenance</b>	50,000 Hours
<b>Dominant Wavelength</b>	590 nm
<b>Warranty</b>	5 years

## DIMENSIONS

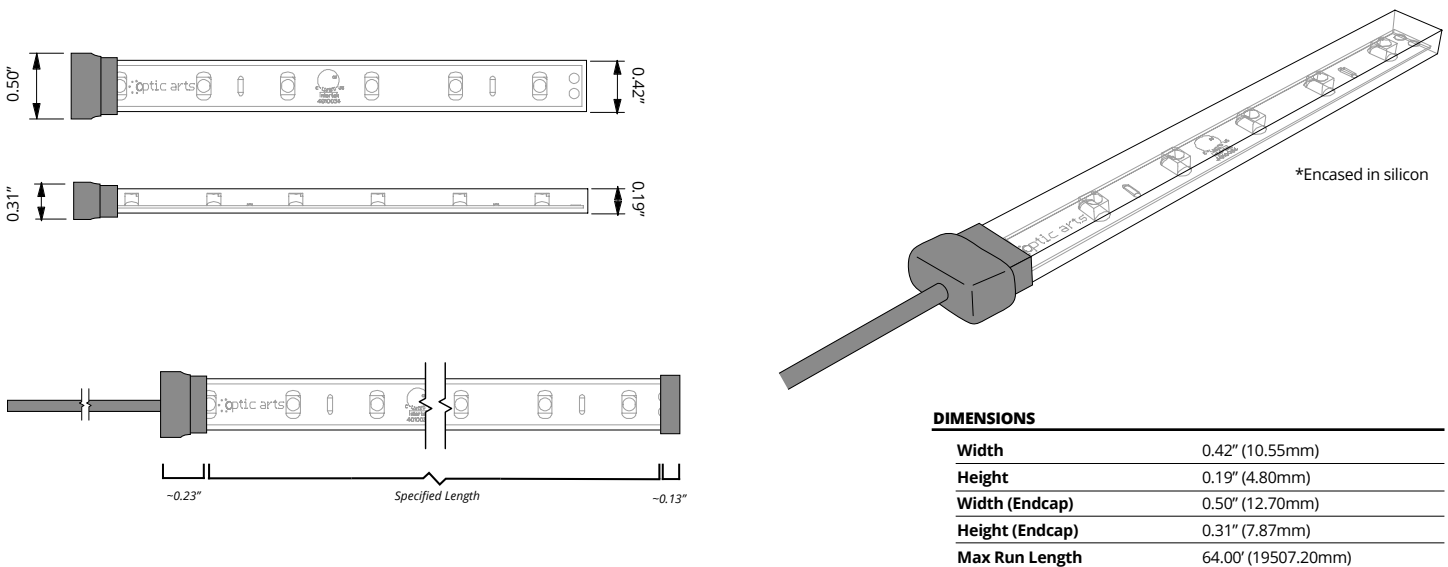

### DIMENSIONS

<b>Width</b>	0.42" (10.55mm)
<b>Height</b>	0.19" (4.80mm)
<b>Width (Endcap)</b>	0.50" (12.70mm)
<b>Height (Endcap)</b>	0.31" (7.87mm)
<b>Max Run Length</b>	64.00' (19507.20mm)

## KEY

### CHANNEL PART NUMBER BREAKDOWN:

CHS	+	R	+	1208
SERIES		APPLICATION		DIMENSIONS
CHS = Slim Channel CHW = Wide Channel		S = Surface Mount R = Recessed Mount C = Corner Mount H = Hanging Mount		XXXX = W x H (mm)

**CHS-R-1208** 

• Click on channel titles below to access complete channel cut sheets



Not Blended



Blended w/Milky Lens



Center Blend

## CHS-R-1208



### MATERIAL

Anodized Aluminum

### DESCRIPTION

Slim and shallow recessed channel.

### LENGTH

2 meter

### LENS TYPES

Clear	CHS-12mm-CC
Frosted	CHS-12mm-CF
Milky	CHS-12mm-CM

### ACCESSORIES

Endcap	CHS-R-1208-EC
Endcap w/hole	CHS-R-1208-ECH

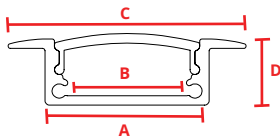

- A:** 0.68" (17.25mm)
- B:** 0.50" (12.59mm)
- C:** 0.98" (25.00mm)
- D:** 0.34" (8.60mm)

## CHS-S-1208



### MATERIAL

Anodized Aluminum

### DESCRIPTION

Slim and shallow surface mounted channel.

### LENGTH

2 meter

### LENS TYPES

Clear	CHS-12mm-CC
Frosted	CHS-12mm-CF
Milky	CHS-12mm-CM
Grazer	CHS-12mm-CG

### ACCESSORIES

Endcap	CHS-S-1208-EC
Endcap w/hole	CHS-S-1208-ECH
Mounting Clip	CHS-S-1208-MC
Rotating Mounting Clip	CHS-S-1208-MCR

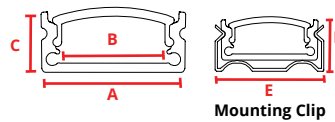

- A:** 0.68" (17.25mm)
- B:** 0.50" (12.59mm)
- C:** 0.34" (8.60mm)
- D:** 0.40" (12.70mm)
- E:** 0.78" (19.90mm)

## CHS-C-1919



### MATERIAL

Anodized Aluminum

### DESCRIPTION

Slim corner mount channel.

### LENGTH

2 meter

### LENS TYPES

Clear	CHS-12mm-CC
Frosted	CHS-12mm-CF
Milky	CHS-12mm-CM

### ACCESSORIES

Endcap	CHS-C-1919-EC
Endcap w/hole	CHS-C-1919-ECH
Mounting Clip	CHS-C-1919-MC

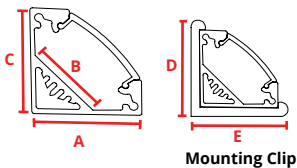

- A:** 0.73" (18.50mm)
- B:** 0.48" (12.20mm)
- C:** 0.73" (18.50mm)
- D:** 0.82" (20.82mm)
- E:** 0.82" (20.82mm)

## CHS-R-1715



### MATERIAL

Anodized Aluminum

### DESCRIPTION

Slim and deep recessed channel. Eliminates visible LED nodes when used with FLEXDC 3.0 and milk lens.

### LENGTH

2 meter

### LENS TYPES

Clear	CHS-12mm-CC
Frosted	CHS-12mm-CF
Milky	CHS-12mm-CM
Grazer	CHS-12mm-CG

### ACCESSORIES

Endcap	CHS-R-1715-EC
Endcap w/hole	CHS-R-1715-ECH

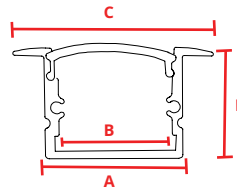

- A:** 0.68" (17.25mm)
- B:** 0.48" (12.30mm)
- C:** 0.98" (25.00mm)
- D:** 0.59" (15.05mm)

MOUNTING OPTIONS - COMPATIBLE CHANNELS



Not Blended



Blended w/Milky Lens

## CHS-S-1715



### MATERIAL

Anodized Aluminum

### DESCRIPTION

Slim and deep surface mounted channel. Eliminates visible LED nodes when used with FLEXDC 3.0 and milky lens.

### LENGTH

2 meter

### LENS TYPES

Clear	CHS-12mm-CC
Frosted	CHS-12mm-CF
Milky	CHS-12mm-CM
Grazer	CHS-12mm-CG

### ACCESSORIES

Endcap	CHS-S-1715-EC
Endcap w/hole	CHS-S-1715-ECH
Mounting Clip	CHS-S-1715-MC
Rotating Mounting Clip	CHS-S-1715-MCR

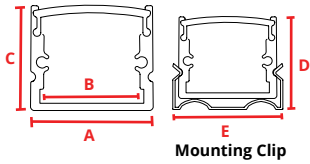

**A:** 0.68" (17.25mm)  
**B:** 0.48" (12.30mm)  
**C:** 0.59" (15.05mm)  
**D:** 0.66" (16.76mm)  
**E:** 0.78" (19.90mm)

## CHS-C-1616



### MATERIAL

Anodized Aluminum

### DESCRIPTION

Slim corner mount channel with rounded lens.

### LENGTH

2 meter

### LENS TYPES

Frosted	CHS-C-1616-CF
Milky	CHS-C-1616-CM

### ACCESSORIES

Endcap	CHS-C-1616-EC
Endcap w/hole	CHS-C-1616-ECH
Mounting Clip	CHS-C-1616-MC

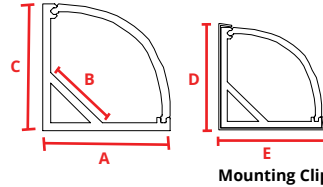

**A:** 0.63" (16.00mm)  
**B:** 0.39" (10.00mm)  
**C:** 0.63" (16.00mm)  
**D:** 0.70" (17.78mm)  
**E:** 0.70" (17.78mm)

## CHS-S-1922S



### MATERIAL

Anodized Aluminum

### DESCRIPTION

Slim surface mounted channel with square wrap around lens. Mounting clip is fully concealed within fixture base.

### LENGTH

2 meter

### LENS TYPES

Milky	CHW-S-1922S-CM
-------	----------------

### ACCESSORIES

Endcap	CHS-S-1922S-EC
Endcap w/hole	CHS-S-1922S-ECH
Mounting Clip	CHS-S-1922S-MC

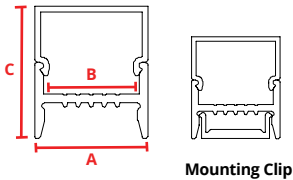

**A:** 0.77" (19.50mm)  
**B:** 0.65" (16.50mm)  
**C:** 0.86" (21.80mm)

## CHS-S-1922R



### MATERIAL

Anodized Aluminum

### DESCRIPTION

Slim surface mounted channel with rounded wrap around lens. Mounting clip is fully concealed within fixture base.

### LENGTH

2 meter

### LENS TYPES

Milky	CHW-S-1922R-CM
-------	----------------

### ACCESSORIES

Endcap	CHS-S-1922R-EC
Endcap w/hole	CHS-S-1922R-ECH
Mounting Clip	CHS-S-1922R-MC

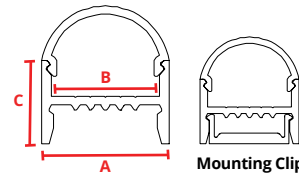

**A:** 0.77" (19.50mm)  
**B:** 0.65" (16.50mm)  
**C:** 0.86" (21.80mm)

## CHW-S-2010



### MATERIAL

Anodized Aluminum

### DESCRIPTION

Low profile surface mounted channel.

### LENGTH

2 meter

### LENS TYPES

Clear	CHW-S-2010-CC
Frosted	CHW-S-2010-CF
Milky	CHW-S-2010-CM

### ACCESSORIES

Endcap	CHW-S-2010-EC
Endcap w/hole	CHW-S-2010-ECH
Mounting Clip	CHW-S-2010-MC
Rotating Mounting Clip	CHW-S-2010-MCR

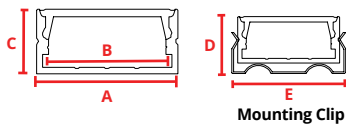

**A:** 0.93" (23.50mm)  
**B:** 0.78" (20.00mm)  
**C:** 0.39" (10.00mm)  
**D:** 0.48" (12.19mm)  
**E:** 1.02" (25.80mm)

## CHW-R-2010



### MATERIAL

Anodized Aluminum

### DESCRIPTION

Recessed wide-profile channel.

### LENGTH

2 meter

### LENS TYPES

Clear	CHW-R-2010-CC
Frosted	CHW-R-2010-CF
Milky	CHW-R-2010-CM

### ACCESSORIES

Endcap	CHW-R-2010-EC
Endcap w/hole	CHW-R-2010-ECH

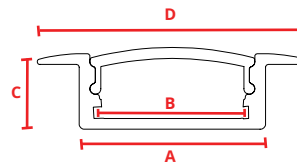

**A:** 0.93" (23.50mm)  
**B:** 0.78" (20.00mm)  
**C:** 0.39" (10.00mm)  
**D:** 1.19" (30.24mm)

MOUNTING OPTIONS - COMPATIBLE CHANNELS



Not Blended



Blended w/Milky Lens

## CHW-C-3030



**MATERIAL**  
Anodized Aluminum

**DESCRIPTION**  
45 degree channel with rounded lens.

**LENGTH**  
2 meter

**LENS TYPES**  
Clear CHW-C-3030-CC  
Frosted CHW-C-3030-CF  
Milky CHW-C-3030-CM

**ACCESSORIES**  
Endcap CHW-C-3030-EC  
Endcap w/hole CHW-C-3030-ECH  
Mounting Clip CHW-C-3030-MC

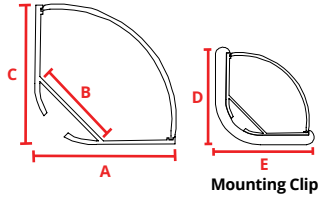

- A:** 1.18" (30.00mm)
- B:** 0.78" (20.20mm)
- C:** 1.18" (30.00mm)
- D:** 1.29" (32.77mm)
- E:** 1.29" (32.77mm)

## CHW-C-3030S



**MATERIAL**  
Anodized Aluminum

**DESCRIPTION**  
45 degree channel with square lens.

**LENGTH**  
2 meter

**LENS TYPES**  
Clear CHW-C-3030S-CC  
Frosted CHW-C-3030S-CF  
Milky CHW-C-3030S-CM

**ACCESSORIES**  
Endcap CHW-C-3030S-EC  
Endcap w/hole CHW-C-3030S-ECH  
Mounting Clip CHW-C-3030S-MC

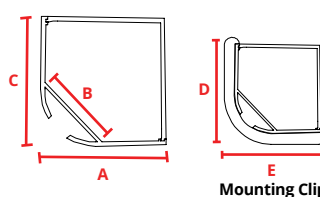

- A:** 1.18" (30.00mm)
- B:** 0.78" (20.20mm)
- C:** 1.18" (30.00mm)
- D:** 1.29" (32.77mm)
- E:** 1.29" (32.77mm)

## CHW-S/H-3535



**MATERIAL**  
Anodized Aluminum

**DESCRIPTION**  
Wide and deep surface mounted or hanging channel. Eliminates visible LED nodes for most FLEXDC products when used with a milky lens.

**LENGTH**  
2 meter

**LENS TYPES**  
Frosted CHW-35mm-CF  
Milky CHW-35mm-CM

**ACCESSORIES**  
Endcap CHW-S-3535-EC  
Endcap w/hole CHW-S-3535-ECH  
Mounting Clip CHW-S-3535-MC  
Hanging Hardware CHW-SH-3535-MW  
Bracket Straight CHW-S-XX35-B5  
Bracket 90° Flat CHW-S-XX35-B90F  
Bracket 90° Raised CHW-S-XX35-B90R  
End Cap for FLEX AC CHW-S-3535-ECAC  
Mounting Clip for FLEX AC CHW-S-3535-MCAC  
VHB Tape VHBTAPE.AC

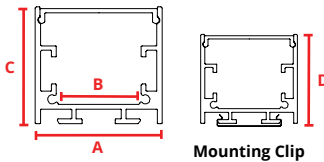

- A:** 1.39" (35.25mm)
- B:** 0.96" (24.50mm)
- C:** 1.39" (35.25mm)
- D:** 1.54" (39.00mm)

\*Must specify for hanging or surface mount application.

## CHW-R-4435



**MATERIAL**  
Anodized Aluminum

**DESCRIPTION**  
Wide and deep recessed channel. Eliminates visible LED nodes for most FLEXDC products when used with a milky lens. Can be securely and conveniently mounted with CHW-R-4435-SC spring clip.

**LENGTH**  
2 meter

**LENS TYPES**  
Frosted CHW-35mm-CF  
Milky CHW-35mm-CM

**ACCESSORIES**  
Endcap CHW-R-4435-EC  
Endcap w/hole CHW-R-4435-ECH  
Mounting Clip CHW-R-4435-SC  
Bracket Straight CHW-S-XX35-B5  
Bracket 90° Flat CHW-S-XX35-B90F  
Bracket 90° Raised CHW-S-XX35-B90R  
End Cap for FLEX AC CHW-R-4435-ECAC  
Mounting Clip for FLEX AC CHW-R-4435-MCAC  
VHB Tape VHBTAPE.AC

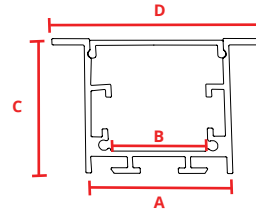

- A:** 1.39" (35.25mm)
- B:** 0.96" (24.50mm)
- C:** 1.39" (35.25mm)
- D:** 2.00" (51.04mm)

## CHW-S/H-2027



**MATERIAL**  
Anodized Aluminum

**DESCRIPTION**  
Small surfaced mounted or hanging channel with wrap around lens.

**LENGTH**  
2 meter

**LENS TYPES**  
Clear CHW-SH-2027-CC  
Frosted CHW-SH-2027-CF  
Milky CHW-SH-2027-CM

**ACCESSORIES**  
Endcap CHW-SH-2027-EC  
End Cap w/hole CHW-SH-2027-ECH  
Hanging Hardware CHW-SH-MW  
Bracket Straight CHW-SH-B5  
Bracket 90° Flat CHW-SH-B90F  
Bracket 90° Raised CHW-SH-B90R

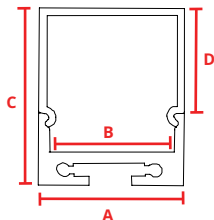

- A:** 0.79" (20.30mm)
- B:** 0.66" (16.70mm)
- C:** 1.06" (27.00mm)
- D:** 0.76" (19.50mm)

\*Must specify for hanging or surface mount application.

## CHW-S/H-3561



**MATERIAL**  
Anodized Aluminum

**DESCRIPTION**  
Large surface mounted or hanging channel with wrap around lens.

**LENGTH**  
2 meter

**LENS TYPES**  
Milky CHW-SH-3561-CM

**ACCESSORIES**  
Endcap CHW-SH-3561-EC  
End Cap w/hole CHW-SH-3561-ECH  
Hanging Hardware CHW-SH-MW  
Bracket Straight CHW-SH-B5  
Bracket 90° Flat CHW-SH-B90F  
Bracket 90° Raised CHW-SH-B90R

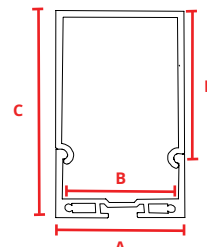

- A:** 1.38" (35.00mm)
- B:** 1.24" (31.40mm)
- C:** 2.43" (61.70mm)
- D:** 1.57" (39.90mm)

\*Must specify for hanging or surface mount application.

MOUNTING OPTIONS - COMPATIBLE CHANNELS



Not Blended



Blended w/Milky Lens

## CHW-S/H-7532



**MATERIAL**  
Anodized Aluminum

**DESCRIPTION**  
Wide surface mounted or hanging channel with flat lens.

**LENGTH**  
2 meter

**LENS TYPES**  
Frosted CHW-SH-7532-CF

**ACCESSORIES**  
**Endcap** CHW-SH-7532-EC  
**Endcap w/hole** CHW-SH-7532-ECH  
**Hanging Hardware** CHW-SH-MW  
**Bracket Straight** CHW-SH-BS  
**Bracket 90° Flat** CHW-SH-B90F  
**Bracket 90° Raised** CHW-SH-B90R

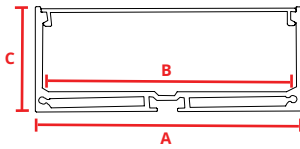

**A:** 2.95" (75.00mm)  
**B:** 2.52" (64.00mm)  
**C:** 1.26" (32.00mm)

\*Must specify for hanging or surface mount application.

## CHW-S-2623



**MATERIAL**  
Anodized Aluminum

**DESCRIPTION**  
Surface mounted channel with wrap around lens.

**LENGTH**  
2 meter

**LENS TYPES**  
Milky CHW-S-2623-CM

**ACCESSORIES**  
**Endcap** CHW-S-2623-EC  
**Endcap w/hole** CHW-S-2623-ECH

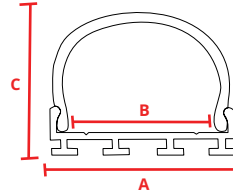

**A:** 1.03" (26.20mm)  
**B:** 0.80" (20.35mm)  
**C:** 0.89" (22.76mm)

## CHW-S/H-3030



**MATERIAL**  
Anodized Aluminum

**DESCRIPTION**  
Wide and deep surface mounted or hanging channel with flat lens for even blending.

**LENGTH**  
2 meter

**LENS TYPES**  
Milky CHW-SH-3030-CM

**ACCESSORIES**  
**Endcap** CHW-SH-3030-EC  
**Endcap w/hole** CHW-SH-3030-ECH  
**Hanging Hardware** CHW-SH-MW  
**Bracket Straight** CHW-SH-BS  
**Bracket 90° Flat** CHW-SH-B90F  
**Bracket 90° Raised** CHW-SH-B90R  
**End Cap for FLEX AC** CHW-SH-3030-ECAC  
**Mounting Clip for FLEX AC** CHW-SH-3030-MCAC  
**VHB Tape** VHBTAPE.AC

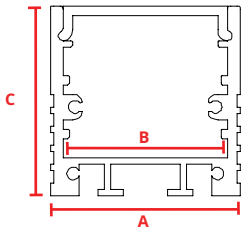

**A:** 1.18" (30.00mm)  
**B:** 1.01" (25.60mm)  
**C:** 1.18" (30.00mm)

\*Must specify for hanging or surface mount application.

## CHC-S-1921



**MATERIAL**  
Anodized Aluminum

**DESCRIPTION**  
Surface mount channel with flat lens. Mounts to ferrous and non-ferrous surfaces using magnets with no visible fasteners once mounted.

**LENGTH**  
2 meter

**LENS TYPES**  
Milky CHC-S-1921-CM

**ACCESSORIES**

**Anodized Aluminum Endcap** CHC-S-1921-EC  
**Anodized Aluminum Endcap w/hole** CHC-S-1921-ECH  
**Channel Mounted Magnet** CHC-S-1921-MA  
**Wall Mounted Magnet** CHC-S-1921-M  
**1' Mounting Plate** CHC-S-1921-B1

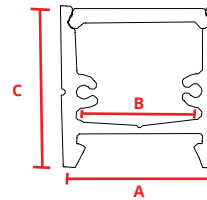

**A:** 0.76" (19.43mm)  
**B:** 0.55" (14.09mm)  
**C:** 0.84" (21.43mm)

## ACCESSORIES

### LC-O2P-F

Outdoor Lead Connector  
(Female)

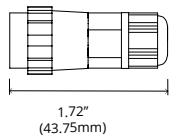
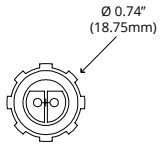
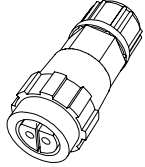

### LC-O2P-M

Outdoor Lead Connector  
(Male)

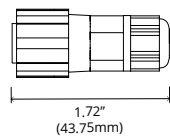
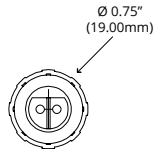
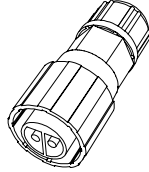

### FLEXMNT.SIL.EXT12

Outdoor Mounting Clip

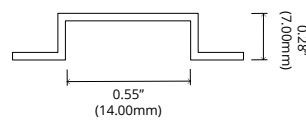
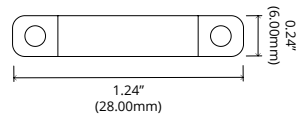
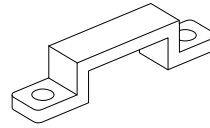

### FLEX.ZIP

Strain Relief Clip

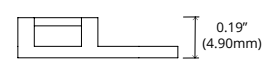
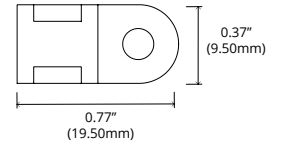
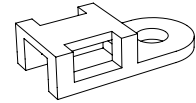

## COMPATIBLE DRIVERS

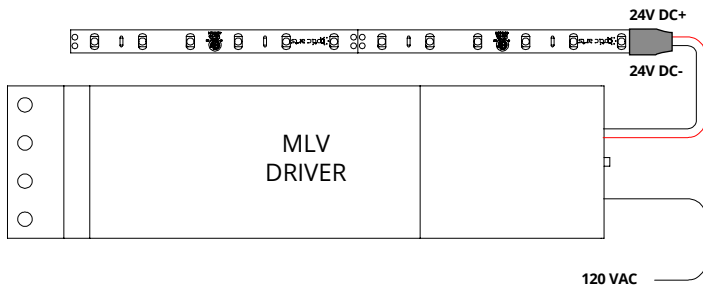

## MLV (MLV)

PART	DESCRIPTION
ML10S24VDC	10W 120VAC DIMMABLE DRIVER
ML20S24VDC	20W 120VAC DIMMABLE DRIVER
ML35S24VDC	35W 120VAC DIMMABLE DRIVER
ML35S24VDC-277	35W 277VAC DIMMABLE DRIVER
ML40S24VDC	40W 120VAC DIMMABLE DRIVER
ML50S24VDC	50W 120VAC DIMMABLE DRIVER
ML50S24VDC-277	50W 277VAC DIMMABLE DRIVER
ML60S24VDC	60W 120VAC DIMMABLE DRIVER
ML75S24VDC	75W 120VAC DIMMABLE DRIVER
ML75S24VDC-277	75W 277VAC DIMMABLE DRIVER
ML96S24VDC	96W 120VAC DIMMABLE DRIVER
ML96S24VDC-277	96W 120VAC DIMMABLE DRIVER
EM2-200S24DC	200W 120VAC DIMMABLE DRIVER, 2 96W CIRCUITS
EM3-300S24DC	300W 120VAC DIMMABLE DRIVER, 3 96W CIRCUITS
EM2-200S24DC-277	200W 120VAC DIMMABLE DRIVER, 2 96W CIRCUITS
EM3-300S24DC-277	288W 120VAC DIMMABLE DRIVER, 3 96W CIRCUITS

### DIMENSIONS

10W-50W	H 2.11"; W 7.38"; D 1.60"
60W-96W	H 3.93"; W 8.13"; D 1.59"
200-300W	H 5.69"; W 10.29"; D 3.13"

### DIMMING PERFORMANCE

MLV DRIVER	Dims to 20% on most MLV dimmers
------------	---------------------------------

*NOTE: Must be loaded between 75%-100% of rated load to maintain FLEX DC® warranty*

### 120 VAC WIRING

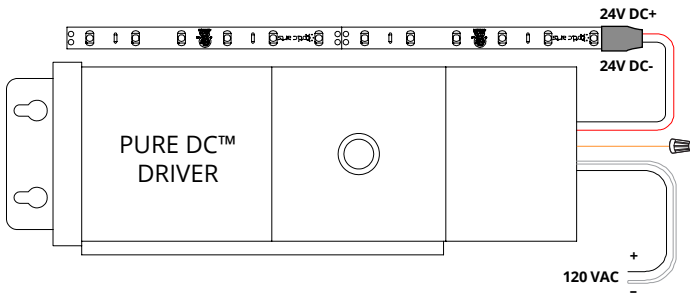

### 277 VAC WIRING

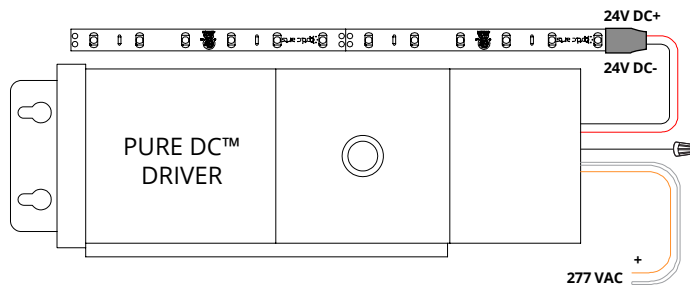

## PURE DC™ MLV (PDC)

PART	DESCRIPTION
PDC.40.24	40W 120/277VAC PURE DC™ MLV DIMMABLE DRIVER
PDC.96.24	96W 120/277VAC PURE DC™ MLV DIMMABLE DRIVER

### DIMENSIONS

40W	L 14.25"; W 3.00"; H 2.88"
96W	L 14.75"; W 4.31"; H 4.81"

### DIMMING PERFORMANCE

PURE DC™ DRIVER	Dims to 0.1% on most MLV dimmers
-----------------	----------------------------------



## COMPATIBLE DRIVERS

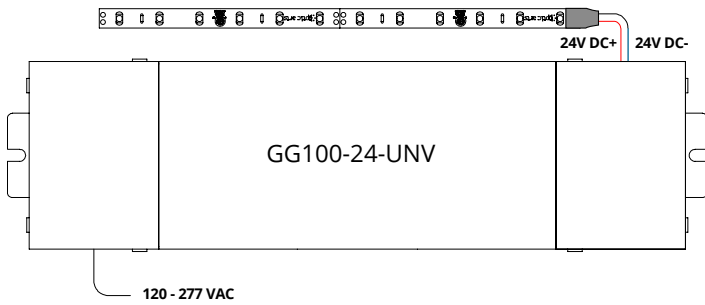

## ELECTRONIC DRIVER - NON-DIM (ND)

PART	DESCRIPTION
GG100E-24-UNV	96W 120-277VAC ELECTRONIC DRIVER
<b>DIMENSIONS</b>	
ELECTRONIC DRIVER	H 3.00"; W 11.46"; D 1.30"
<b>DIMMING PERFORMANCE</b>	
ELECTRONIC DRIVER	Non-Dim

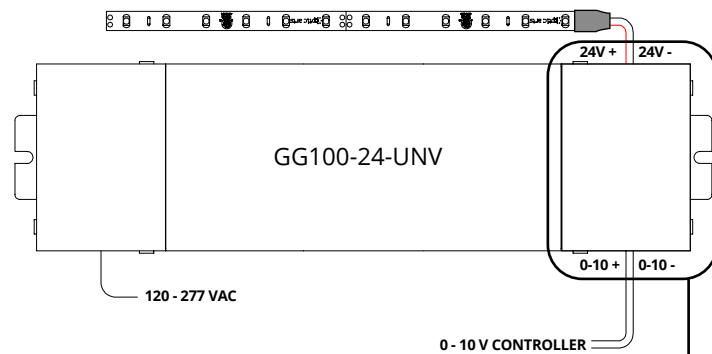

## ELECTRONIC DRIVER W/O-10V MODULE (010)

PART	DESCRIPTION
GG100E-24-UNV-010V	96W 120-277VAC ELECTRONIC DRIVER WITH 0-10V DIMMING MODULE (SINK)
<b>DIMENSIONS</b>	
ELECTRONIC DRIVER - 0-10V	H 3.00"; W 11.46"; D 1.30"
<b>DIMMING PERFORMANCE</b>	
ELECTRONIC DRIVER - 0-10V	Dims below 1% on most 0-10V dimmers

### FIELD INSTALLED IN LOW VOLTAGE WIRING COMPARTMENT

- Install DIM-010V Module in low voltage wiring compartment.
- Max number of 25 modules on one dimmer. Consult dimmer datasheet for maximum device limitation of a specific controller.

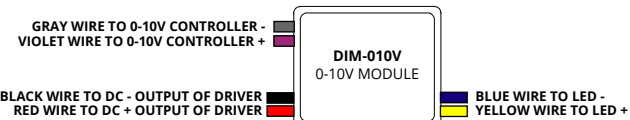

## COMPATIBLE DRIVERS

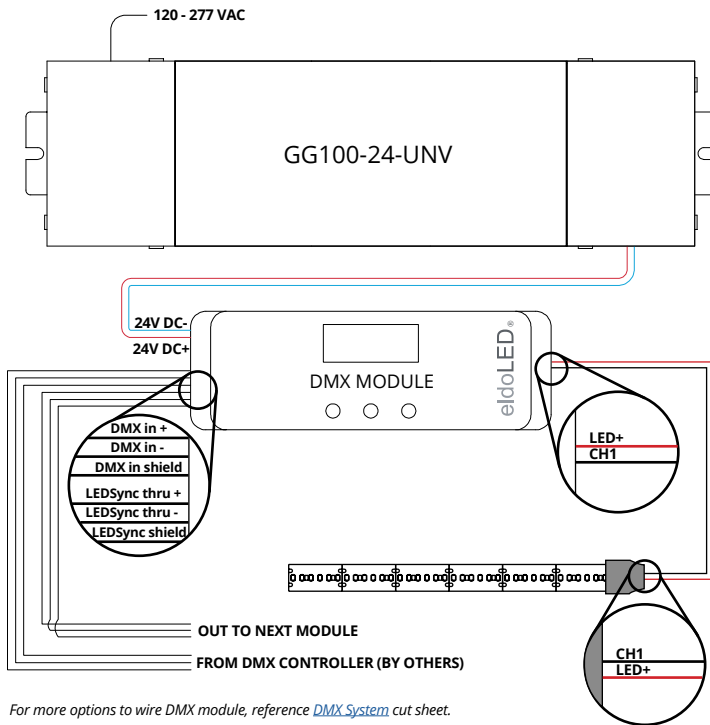

For more options to wire DMX module, reference [DMX System](#) cut sheet.

## ELECTRONIC DRIVER W/DMX MODULE (DMX)

PART	DESCRIPTION
GG100E-24-UNV-DMX	96W 120-277VAC ELECTRONIC DRIVER WITH eldoLED DMX DIMMING MODULE

### DIMENSIONS

96W	H 3.00"; W 11.46"; D 1.30"
DMX MODULE	H 1.97"; W 6.02"; D 0.91"

\*Must be installed in UL box (by others)

### DIMMING PERFORMANCE

ELECTRONIC DRIVER - DMX MODULE Dims to 0.1% on most DMX systems

# FLEX DC® 15 WILDLIFE

# Specification Sheet

COMPATIBLE DRIVERS

## DIMMER WITH NEUTRAL

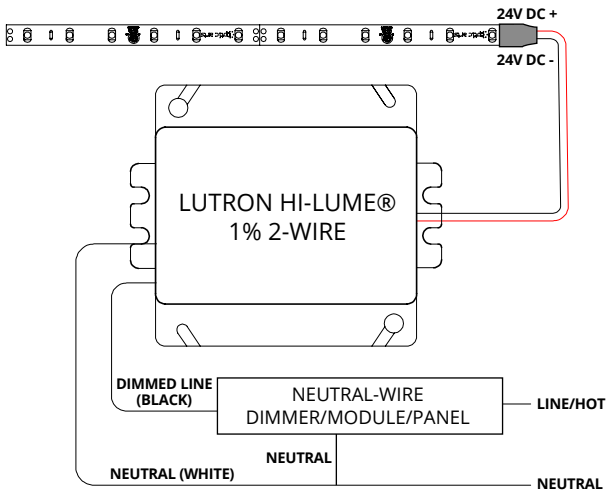

## DIMMER WITHOUT NEUTRAL

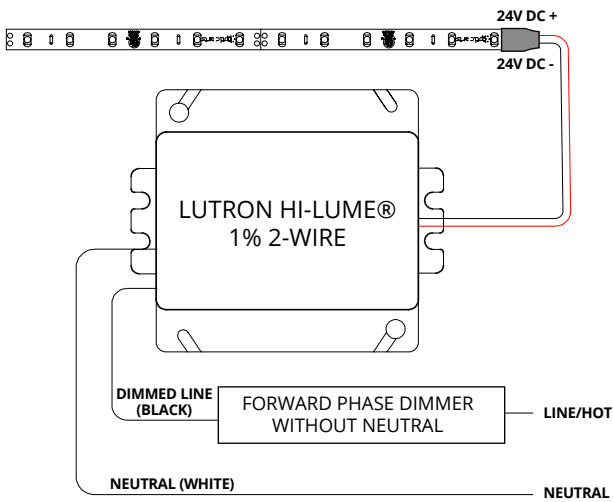

**LUTRON HI-LUME® 1% 2-WIRE:**  
2-WIRE CONTROL FORWARD PHASE



PART	DESCRIPTION
LTEA4U1UKL-CV240	5-40W, 120VAC, 2-WIRE FORWARD PHASE DRIVER
DIMENSIONS	
LUTRON HI-LUME® 1% 2-WIRE	H 4.00"; W 4.89"; D 2.62"
DIMMING PERFORMANCE	
LUTRON HI-LUME® 1% 2-WIRE	Dims to 1% with compatible Lutron controls

COMPATIBLE DRIVERS

### 3-WIRE

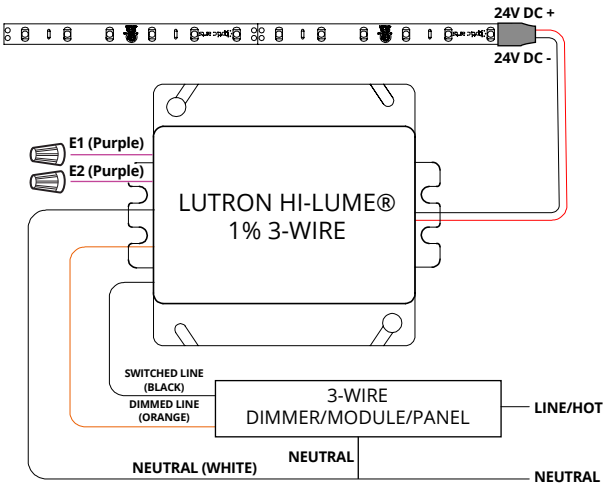

### ECOSYSTEM

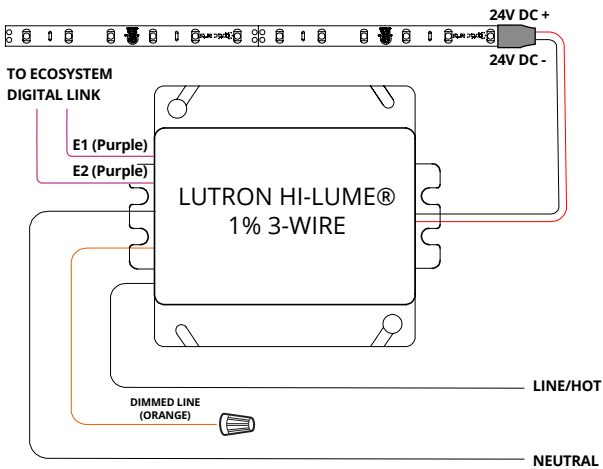

### LUTRON HI-LUME® 1%: 3-WIRE/ECOSYSTEM



PART	DESCRIPTION
L3DA4U1UKL-CV240	5-40W, 120-277VAC, 3-WIRE/ECOSYSTEM DRIVER
DIMENSIONS	
LUTRON HI-LUME® 1% 3-WIRE/ ECOSYSTEM	H 4.00"; W 4.89"; D 2.62"
DIMMING PERFORMANCE	
LUTRON HI-LUME® 1% 3-WIRE/ECOSYSTEM	Dims to 1% with compatible Lutron controls

COMPATIBLE DRIVERS

### 3-WIRE

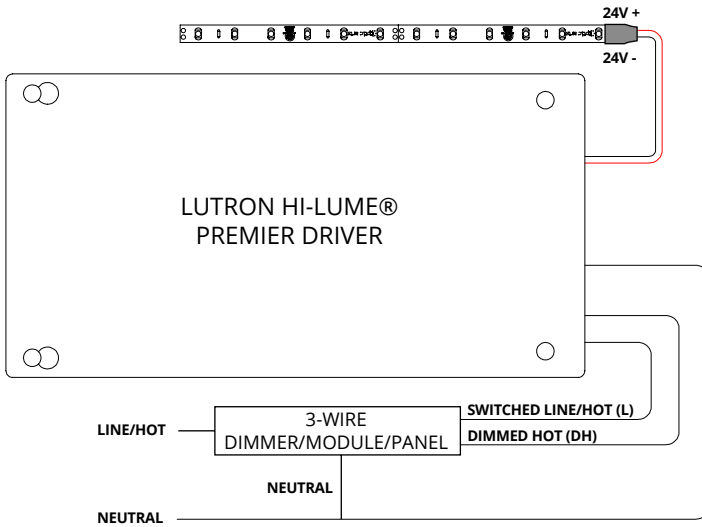

### LUTRON HI-LUME® PREMIER: 3-WIRE/ECOSYSTEM



PART	DESCRIPTION
L3D0-96W24V-U	2-96W, 120-277VAC, 3-WIRE/ECOSYSTEM DRIVER

DIMENSIONS	
HI-LUME® PREMIER	H 5.5"; W 10.5"; D 2.0"

DIMMING PERFORMANCE	
LUTRON HI-LUME® PREMIER	Dims to 0.1% with compatible Lutron controls
<i>NOTE: Lutron soft-on, fade to black technology available with Ecosystem Digital Control only.</i>	

### ECOSYSTEM

