



FLEX CONNECT™ is a high performance flexible LED fixture that utilizes a quick-connect system allowing pieces to be cut and connected on site. Soldering is no longer necessary to attach power feeds.

ELECTRICAL

Input Voltage	24VDC
Dimming Options	MLV 0-10 Volt DMX Lutron (2-WIRE, 3-WIRE, EcoSystem) PURE DC™
Power Consumption	3.6 Watts per foot
Wire Size	22AWG, 2 wire
Certification	ETL - Conforms to UL Std. 2108; Certified to CSA Std. C22.2 No. 9.0.

PHYSICAL

Field Cuttable	Every 3.00"
Operating Temperature	-40° C (-40°F) to +50°C (+122°F)
Environment	IP20 - Dry Location
Maximum Run Length	25'
Dimensions (WxH)	IP20 - 0.39" (10.00mm) x 0.08" (2.00mm) Connector - 0.35" (9.29mm) x 0.38" (9.81mm)

MOUNTING OPTIONS

Mounting Clips	FLEXMNT.SIL.INT (pg. 3)
Channels	Optic Arts Channel (pg.4-7)

PERFORMANCE

CRI	90+
Lumen Maintenance	70,000 Hours L70 @ 25°C ambient 50,000 Hours L70 @ 50°C ambient
Warranty	3 years

LUMEN OUTPUT

2000K	218.00 lm/ft 60.55 lm/watt
2700K	276.00 lm/ft 76.67 lm/watt
3000K	287.00 lm/ft 79.72 lm/watt
3500K	297.00 lm/ft 82.50 lm/watt

*Stated lumen values have a tolerance of +/- 10%.

PART NUMBER BUILDER

SERIES	+	IP RATING	+	COLOR	+	VOLTAGE	+	WATTAGE	+	LENGTH
FLEXCN		20 = IP20, Dry Location		20 = 2000k 27 = 2700k 30 = 3000k 35 = 3500k		24 = 24 VDC		36 = 3.6		XX = Custom Length

DIMENSIONS

Optic Arts cuts all FLEX CONNECT™ and Channel products to length per customer specifications. Each length of FLEX DC CONNECT™ is packaged on a reel in an anti-static bag. Bags are labeled with fixture type, length and location (if applicable). Each piece of channel is labeled with fixture type, length and location (if applicable), and is bundled by fixture type.

- Due to the nature of the FLEX Connect product, specific lengths may not fall exactly on a cutting point. In this case, Optic Arts will always cut to the larger dimension unless otherwise specified.
- Unless otherwise specified, channel is cut 15mm longer than FLEX Connect.
- Some on-site assembly required. See installation guides for details.

INDOOR FLEX CONNECT



INDOOR DIMENSIONS

Width	0.39" (10.00mm)
Height	0.08" (2.00mm)
Cuttable Segment Length	3.00" (77.00mm)
Connector Width	0.35" (9.29mm)
Connector Length	0.38" (9.81mm)
Connector Height	0.19" (4.75mm)
Max Run Length	25.00' (635.00mm)

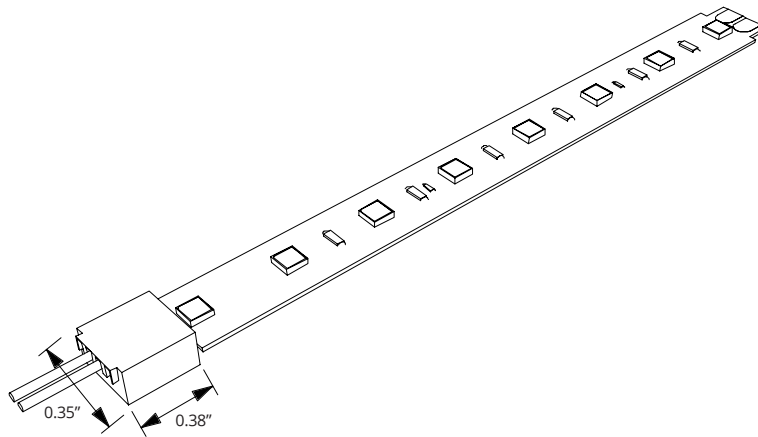

ACCESSORIES

FLEX.ZIP

Strain Relief Clip

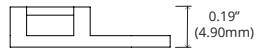
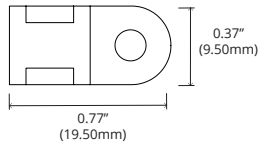
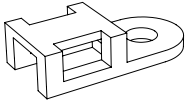

FLEXMNT.SIL.INT

Indoor Mounting Clip

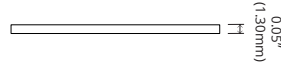
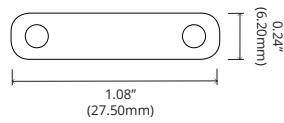
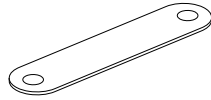

FLEXCN-BSC

Butt Splice Connector

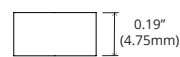
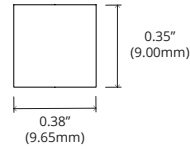
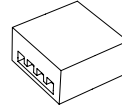

FLEXCN-PFC

Power Feed Connector

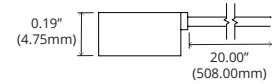
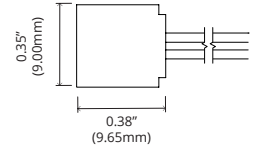
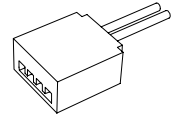

FLEXCN-C90CP

90° Corner Connector

Note: Requires Butt Splice Connectors

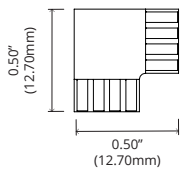
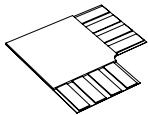

FLEXCN-TCP

T-Connector

Note: Requires Butt Splice Connectors

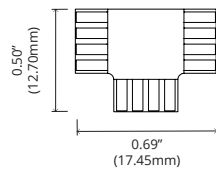
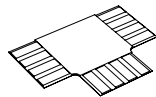

MOUNTING OPTIONS - COMPATIBLE CHANNELS

CHANNEL ACCESSORIES CATALOGUE...



Not Blended



Blended w/Milky Lens

CHS-R-1208

Fits IP40 FLEXDC only

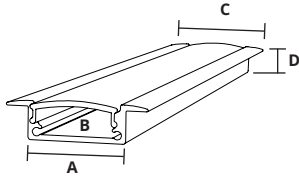

- A:** 0.68" (17.25mm)
- B:** 0.50" (12.59mm)
- C:** 0.98" (25.00mm)
- D:** 0.34" (8.60mm)

MATERIAL

Anodized Aluminum

DESCRIPTION

Slim and shallow recessed channel.

LENGTH

2 meter

LENS TYPES

Clear	CHS-12mm-CC
Frosted	CHS-12mm-CF
Milky	CHS-12mm-CM

ACCESSORIES

Endcap	CHS-R-1208-EC
Endcap w/hole	CHS-R-1208-ECH

CHS-S-1208

Fits IP40 FLEXDC only

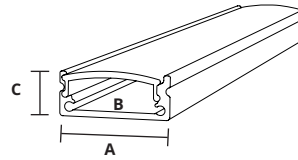

- A:** 0.68" (17.25mm)
- B:** 0.50" (12.59mm)
- C:** 0.34" (8.60mm)

MATERIAL

Anodized Aluminum

DESCRIPTION

Slim and shallow surface mounted channel.

LENGTH

2 meter

LENS TYPES

Clear	CHS-12mm-CC
Frosted	CHS-12mm-CF
Milky	CHS-12mm-CM
Grazer	CHS-12mm-CG

ACCESSORIES

Endcap	CHS-S-1208-EC
Endcap w/hole	CHS-S-1208-ECH
Mounting Clip	CHS-S-1208-MC
Rotating Mounting Clip	CHS-S-1208-MCR

CHS-C-1919

Fits IP40 FLEXDC only

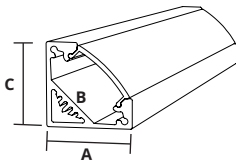

- A:** 0.73" (18.50mm)
- B:** 0.48" (12.20mm)
- C:** 0.73" (18.50mm)

MATERIAL

Anodized Aluminum

DESCRIPTION

Slim corner mount channel.

LENGTH

2 meter

LENS TYPES

Clear	CHS-12mm-CC
Frosted	CHS-12mm-CF
Milky	CHS-12mm-CM

ACCESSORIES

Endcap	CHS-C-1919-EC
Endcap w/hole	CHS-C-1919-ECH
Mounting Clip	CHS-C-1919-MC

CHS-R-1715

Fits IP40 FLEXDC only

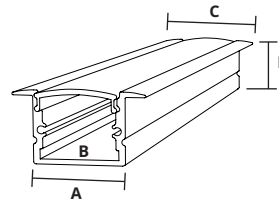

- A:** 0.68" (17.25mm)
- B:** 0.58" (14.75mm)
- C:** 0.98" (25.00mm)
- D:** 0.59" (15.05mm)

MATERIAL

Anodized Aluminum

DESCRIPTION

Slim and deep recessed channel. Eliminates visible LED nodes when used with FLEXDC 3.0 and milk lens.

LENGTH

2 meter

LENS TYPES

Clear	CHS-12mm-CC
Frosted	CHS-12mm-CF
Milky	CHS-12mm-CM
Grazer	CHS-12mm-CG

ACCESSORIES

Endcap	CHS-R-1715-EC
Endcap w/hole	CHS-R-1715-ECH

CHS-S-1715

Fits IP40 FLEXDC only

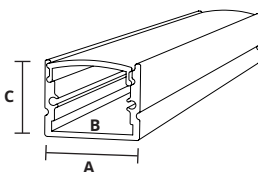

- A:** 0.68" (17.25mm)
- B:** 0.58" (14.75mm)
- C:** 0.59" (15.05mm)

MATERIAL

Anodized Aluminum

DESCRIPTION

Slim and deep surface mounted channel. Eliminates visible LED nodes when used with FLEXDC 3.0 and milky lens.

LENGTH

2 meter

LENS TYPES

Clear	CHS-12mm-CC
Frosted	CHS-12mm-CF
Milky	CHS-12mm-CM
Grazer	CHS-12mm-CG

ACCESSORIES

Endcap	CHS-S-1715-EC
Endcap w/hole	CHS-S-1715-ECH
Mounting Clip	CHS-S-1715-MC
Rotating Mounting Clip	CHS-S-1715-MCR

CHS-C-1616

Fits IP40 FLEXDC only

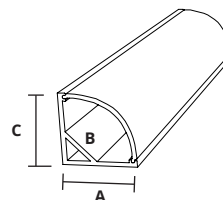

- A:** 0.63" (16.00mm)
- B:** 0.39" (10.00mm)
- C:** 0.63" (16.00mm)

MATERIAL

Anodized Aluminum

DESCRIPTION

Slim corner mount channel with rounded lens.

LENGTH

2 meter

LENS TYPES

Frosted	CHS-C-1616-CF
Milky	CHS-C-1616-CM

ACCESSORIES

Endcap	CHS-C-1616-EC
Endcap w/hole	CHS-C-1616-ECH
Mounting Clip	CHS-C-1616-MC

MOUNTING OPTIONS - COMPATIBLE CHANNELS



Not Blended



Blended w/Milky Lens

CHS-S-1922S

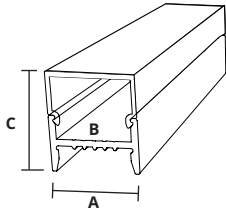

A: 0.77" (19.50mm)
B: 0.65" (16.50mm)
C: 0.86" (21.80mm)

MATERIAL

Anodized Aluminum

DESCRIPTION

Slim surface mounted channel with square wrap around lens. Mounting clip is fully concealed within fixture base.

LENGTH

2 meter

LENS TYPES

Milky CHW-S-1922S-CM

ACCESSORIES

Endcap CHS-S-1922S-EC
 Endcap w/hole CHS-S-1922S-ECH
 Mounting Clip CHS-S-1922S-MC

CHS-S-1922R

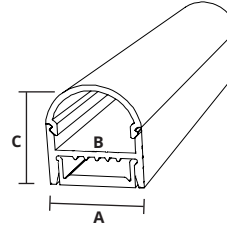

A: 0.77" (19.50mm)
B: 0.65" (16.50mm)
C: 0.86" (21.80mm)

MATERIAL

Anodized Aluminum

DESCRIPTION

Slim surface mounted channel with rounded wrap around lens. Mounting clip is fully concealed within fixture base.

LENGTH

2 meter

LENS TYPES

Milky CHW-S-1922R-CM

ACCESSORIES

Endcap CHS-S-1922R-EC
 Endcap w/hole CHS-S-1922R-ECH
 Mounting Clip CHS-S-1922R-MC

CHW-S-2010

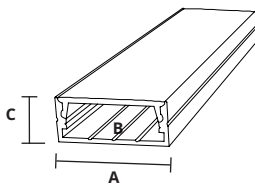

A: 0.93" (23.50mm)
B: 0.78" (20.00mm)
C: 0.39" (10.00mm)

MATERIAL

Anodized Aluminum

DESCRIPTION

Low profile surface mounted channel.

LENGTH

2 meter

LENS TYPES

Clear CHW-S-2010-CC
 Frosted CHW-S-2010-CF
 Milky CHW-S-2010-CM

ACCESSORIES

Endcap CHW-S-2010-EC
 Endcap w/hole CHW-S-2010-ECH
 Mounting Clip CHW-S-2010-MC
 Rotating Mounting Clip CHW-S-2010-MCR

CHW-R-2010

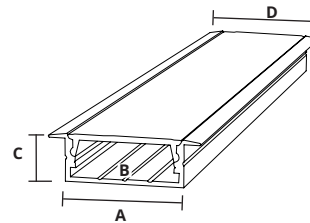

A: 0.93" (23.50mm)
B: 0.78" (20.00mm)
C: 0.39" (10.00mm)
D: 1.19" (30.24mm)

MATERIAL

Anodized Aluminum

DESCRIPTION

Recessed wide-profile channel.

LENGTH

2 meter

LENS TYPES

Clear CHW-R-2010-CC
 Frosted CHW-R-2010-CF
 Milky CHW-R-2010-CM

ACCESSORIES

Endcap CHW-R-2010-EC
 Endcap w/hole CHW-R-2010-ECH

CHW-C-3030

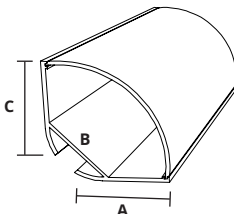

A: 1.18" (30.00mm)
B: 0.78" (20.20mm)
C: 1.18" (30.00mm)

MATERIAL

Anodized Aluminum

DESCRIPTION

45 degree channel with rounded lens.

LENGTH

2 meter

LENS TYPES

Clear CHW-C-3030-CC
 Frosted CHW-C-3030-CF
 Milky CHW-C-3030-CM

ACCESSORIES

Endcap CHW-C-3030-EC
 Endcap w/hole CHW-C-3030-ECH
 Mounting Clip CHW-C-3030-MC

CHW-C-3030S

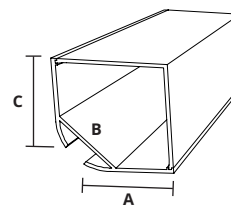

A: 1.18" (30.00mm)
B: 0.78" (20.20mm)
C: 1.18" (30.00mm)

MATERIAL

Anodized Aluminum

DESCRIPTION

45 degree channel with square lens.

LENGTH

2 meter

LENS TYPES

Clear CHW-C-3030S-CC
 Frosted CHW-C-3030S-CF
 Milky CHW-C-3030S-CM

ACCESSORIES

Endcap CHW-C-3030S-EC
 Endcap w/hole CHW-C-3030S-ECH
 Mounting Clip CHW-C-3030S-MC

MOUNTING OPTIONS - COMPATIBLE CHANNELS



Not Blended



Blended w/Milky Lens

CHW-S/H-3535

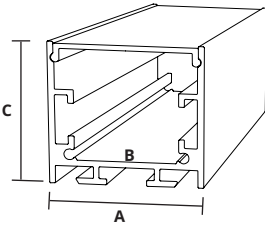

A: 1.39" (35.25mm)
B: 0.96" (24.50mm)
C: 1.39" (35.25mm)

*Must specify for hanging or surface mount application.

MATERIAL

Anodized Aluminum

DESCRIPTION

Wide and deep surface mounted or hanging channel. Eliminates visible LED nodes for most FLEXDC products when used with a milky lens.

LENGTH

2 meter

LENS TYPES

Frosted CHW-35mm-CF
 Milky CHW-35mm-CM

ACCESSORIES

Endcap CHW-S-3535-EC
 Endcap w/hole CHW-S-3535-ECH
 Mounting Clip CHW-S-3535-MC
 Hanging Hardware CHW-SH-3535-MW
 Bracket Straight CHW-S-XX35-BS
 Bracket 90° Flat CHW-S-XX35-B90F
 Bracket 90° Raised CHW-S-XX35-B90R
 End Cap for FLEX AC CHW-S-3535-ECAC
 Mounting Clip for FLEX AC CHW-S-3535-MCAC
 VHB Tape VHBTAPE.AC

CHW-R-4435

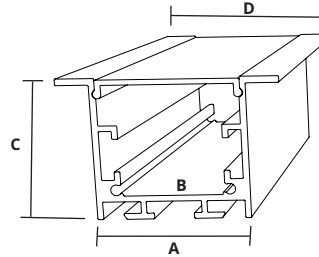

A: 1.39" (35.25mm)
B: 0.96" (24.50mm)
C: 1.39" (35.25mm)
D: 2.00" (51.04mm)

MATERIAL

Anodized Aluminum

DESCRIPTION

Wide and deep recessed channel. Eliminates visible LED nodes for most FLEXDC products when used with a milky lens. Can be securely and conveniently mounted with CHW-R-4435-SC spring clip.

LENGTH

2 meter

LENS TYPES

Frosted CHW-35mm-CF
 Milky CHW-35mm-CM

ACCESSORIES

Endcap CHW-R-4435-EC
 Endcap w/hole CHW-R-4435-ECH
 Mounting Clip CHW-R-4435-SC
 Bracket Straight CHW-S-XX35-BS
 Bracket 90° Flat CHW-S-XX35-B90F
 Bracket 90° Raised CHW-S-XX35-B90R
 End Cap for FLEX AC CHW-R-4435-ECAC
 Mounting Clip for FLEX AC CHW-R-4435-MCAC
 VHB Tape VHBTAPE.AC

CHW-S/H-2027

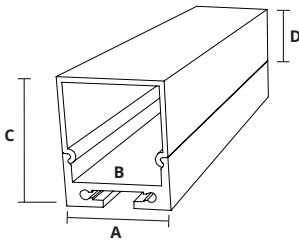

A: 0.79" (20.30mm)
B: 0.66" (16.70mm)
C: 1.06" (27.00mm)
D: 0.76" (19.50mm)

*Must specify for hanging or surface mount application.

MATERIAL

Anodized Aluminum

DESCRIPTION

Small surfaced mounted or hanging channel with wrap around lens.

LENGTH

2 meter

LENS TYPES

Clear CHW-SH-2027-CC
 Frosted CHW-SH-2027-CF
 Milky CHW-SH-2027-CM

ACCESSORIES

Endcap CHW-SH-2027-EC
 End Cap w/hole CHW-SH-2027-ECH
 Hanging Hardware CHW-SH-MW
 Bracket Straight CHW-SH-BS
 Bracket 90° Flat CHW-SH-B90F
 Bracket 90° Raised CHW-SH-B90R

CHW-S/H-3561

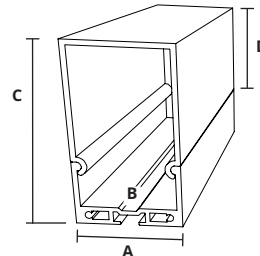

A: 1.38" (35.00mm)
B: 1.24" (31.40mm)
C: 2.43" (61.70mm)
D: 1.57" (39.90mm)

*Must specify for hanging or surface mount application.

MATERIAL

Anodized Aluminum

DESCRIPTION

Large surface mounted or hanging channel with wrap around lens.

LENGTH

2 meter

LENS TYPES

Milky CHW-SH-3561-CM

ACCESSORIES

Endcap CHW-SH-3561-EC
 End Cap w/hole CHW-SH-3561-ECH
 Hanging Hardware CHW-SH-MW
 Bracket Straight CHW-SH-BS
 Bracket 90° Flat CHW-SH-B90F
 Bracket 90° Raised CHW-SH-B90R

CHW-S/H-7532

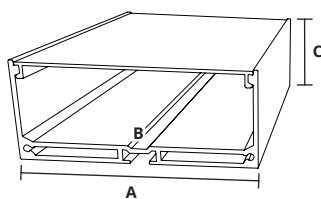

A: 2.95" (75.00mm)
B: 2.52" (64.00mm)
C: 1.26" (32.00mm)

*Must specify for hanging or surface mount application.

MATERIAL

Anodized Aluminum

DESCRIPTION

Wide surface mounted or hanging channel with flat lens.

LENGTH

2 meter

LENS TYPES

Frosted CHW-SH-7532-CF

ACCESSORIES

Endcap CHW-SH-7532-EC
 Endcap w/hole CHW-SH-7532-ECH
 Hanging Hardware CHW-SH-MW
 Bracket Straight CHW-SH-BS
 Bracket 90° Flat CHW-SH-B90F
 Bracket 90° Raised CHW-SH-B90R

CHW-S-2623

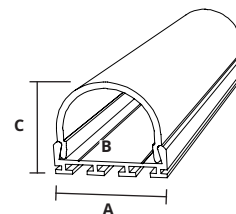

A: 1.03" (26.20mm)
B: 0.80" (20.35mm)
C: 0.89" (22.76mm)

MATERIAL

Anodized Aluminum

DESCRIPTION

Surface mounted channel with wrap around lens.

LENGTH

2 meter

LENS TYPES

Milky CHW-S-2623-CM

ACCESSORIES

Endcap CHW-S-2623-EC
 Endcap w/hole CHW-S-2623-ECH

MOUNTING OPTIONS - COMPATIBLE CHANNELS



Not Blended



Blended w/Milky Lens

CHW-S/H-3030



MATERIAL

Anodized Aluminum

DESCRIPTION

Wide and deep surface mounted or hanging channel with flat lens for even blending.

LENGTH

2 meter

LENS TYPES

Milky CHW-SH-3030-CM

ACCESSORIES

Endcap	CHW-SH-3030-EC
Endcap w/hole	CHW-SH-3030-ECH
Hanging Hardware	CHW-SH-MW
Bracket Straight	CHW-SH-BS
Bracket 90° Flat	CHW-SH-B90F
Bracket 90° Raised	CHW-SH-B90R
End Cap for FLEX AC	CHW-SH-3030-ECAC
Mounting Clip for FLEX AC	CHW-SH-3030-MCAC
VHB Tape	VHBTAPE.AC

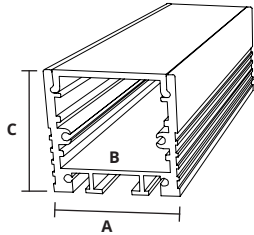

A: 1.18" (30.00mm)

B: 1.01" (25.60mm)

C: 1.18" (30.00mm)

*Must specify for hanging or surface mount application.

CHC-S-1921



MATERIAL

Anodized Aluminum

DESCRIPTION

Surface mount channel with flat lens. Mounts to ferrous and non-ferrous surfaces using magnets with no visible fasteners once mounted.

LENGTH

2 meter

LENS TYPES

Milky CHC-S-1921-CM

ACCESSORIES

Anodized Aluminum Endcap	CHC-S-1921-EC
Anodized Aluminum Endcap w/hole	CHC-S-1921-ECH
Channel Mounted Magnet	CHC-S-1921-MA
Wall Mounted Magnet	CHC-S-1921-M
1" Mounting Plate	CHC-S-1921-B1

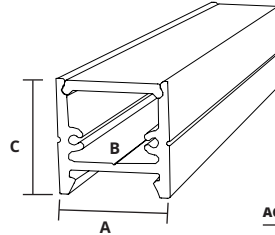

A: 0.76" (19.43mm)

B: 0.55" (14.09mm)

C: 0.84" (21.43mm)

COMPATIBLE DRIVERS

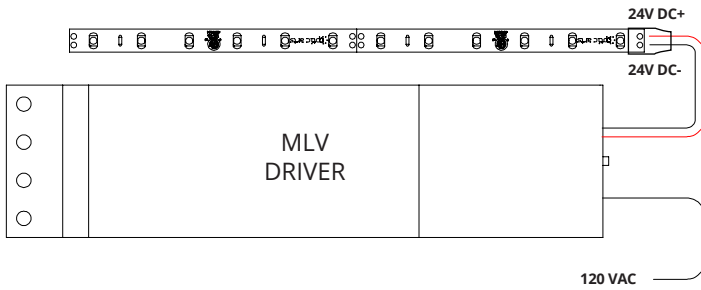

MLV

PART	DESCRIPTION
ML10S24VDC	10W 120VAC DIMMABLE DRIVER
ML20S24VDC	20W 120VAC DIMMABLE DRIVER
ML35S24VDC	35W 120VAC DIMMABLE DRIVER
ML35S24VDC-277	35W 277VAC DIMMABLE DRIVER
ML40S24VDC	40W 120VAC DIMMABLE DRIVER
ML50S24VDC	50W 120VAC DIMMABLE DRIVER
ML50S24VDC-277	50W 277VAC DIMMABLE DRIVER
ML60S24VDC	60W 120VAC DIMMABLE DRIVER
ML75S24VDC	75W 120VAC DIMMABLE DRIVER
ML75S24VDC-277	75W 277VAC DIMMABLE DRIVER
ML96S24VDC	96W 120VAC DIMMABLE DRIVER
ML96S24VDC-277	96W 120VAC DIMMABLE DRIVER
EM2-200S24DC	200W 120VAC DIMMABLE DRIVER, 2 96W CIRCUITS
EM3-300S24DC	300W 120VAC DIMMABLE DRIVER, 3 96W CIRCUITS
EM2-200S24DC-277	200W 120VAC DIMMABLE DRIVER, 2 96W CIRCUITS
EM3-300S24DC-277	288W 120VAC DIMMABLE DRIVER, 3 96W CIRCUITS

DIMENSIONS

10W-50W	H 2.11"; W 7.38"; D 1.60"
60W-96W	H 3.93"; W 8.13"; D 1.59"
200-300W	H 5.69"; W 10.29"; D 3.13"

DIMMING PERFORMANCE

MLV DRIVER Dims to 20% on most MLV dimmers

NOTE: Must be loaded between 75%-100% of rated load to maintain FLEX DC warranty

120 VAC WIRING

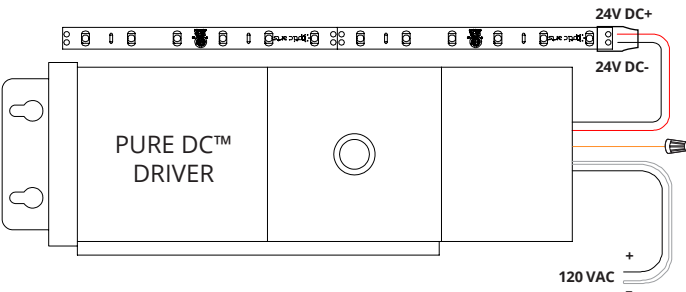

277 VAC WIRING

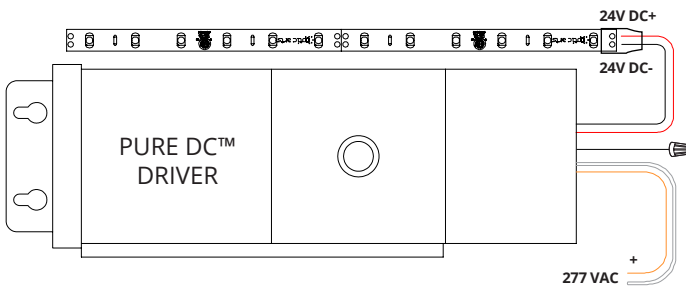

PURE DC™ MLV

PART	DESCRIPTION
PDC.40.24	40W 120VAC PURE DC™ DIMMABLE DRIVER
PDC.96.24	96W 120VAC MLV DIMMABLE DRIVER

DIMENSIONS

PURE DC™ DIMS	H 3.37"; W 11.25"; D 3.25"
---------------	----------------------------

DIMMING PERFORMANCE

PURE DC™ DRIVER Dims to 0.1% on most MLV dimmers

COMPATIBLE DRIVERS

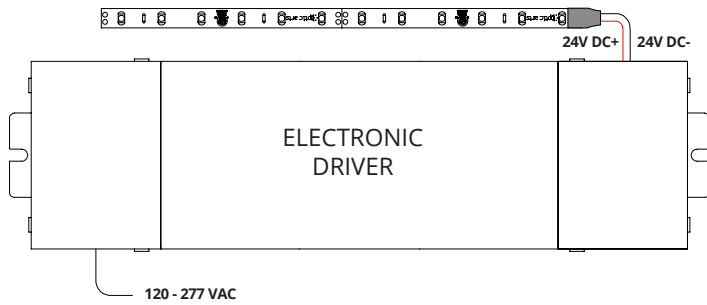

ELECTRONIC DRIVER - NON-DIM

PART	DESCRIPTION
GG100E-24-UNV	ELECTRONIC DRIVER
DIMENSIONS	
ELECTRONIC DRIVER	H 3.00"; W 11.46"; D 1.30"
DIMMING PERFORMANCE	
ELECTRONIC DRIVER	Non-Dim

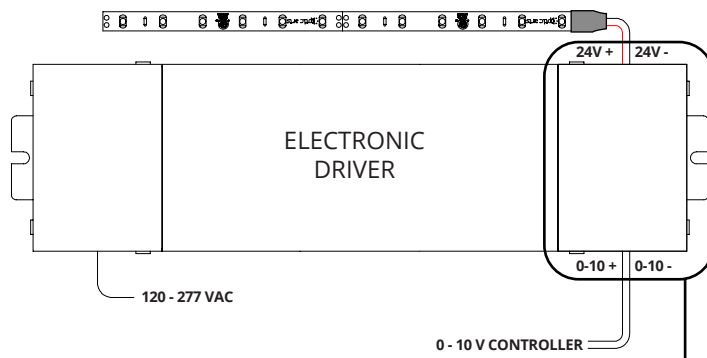

ELECTRONIC DRIVER W/0-10V MODULE

PART	DESCRIPTION
GG100E-24-UNV-010V	96W 120-277VAC ELECTRONIC DRIVER WITH 0-10V DIMMING MODULE (SINK)
DIMENSIONS	
ELECTRONIC DRIVER - 0-10V	H 3.00"; W 11.46"; D 1.30"
DIMMING PERFORMANCE	
ELECTRONIC DRIVER - 0-10V	Dims below 1% on most 0-10V dimmers

FIELD INSTALLED IN LOW VOLTAGE WIRING COMPARTMENT

- Install DIM-010V Module in low voltage wiring compartment.
- Max number of 25 modules on one dimmer. Consult dimmer datasheet for maximum device limitation of a specific controller.

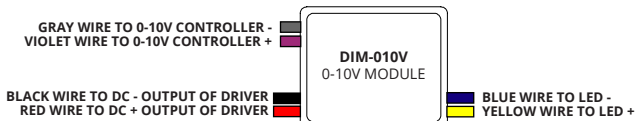

COMPATIBLE DRIVERS

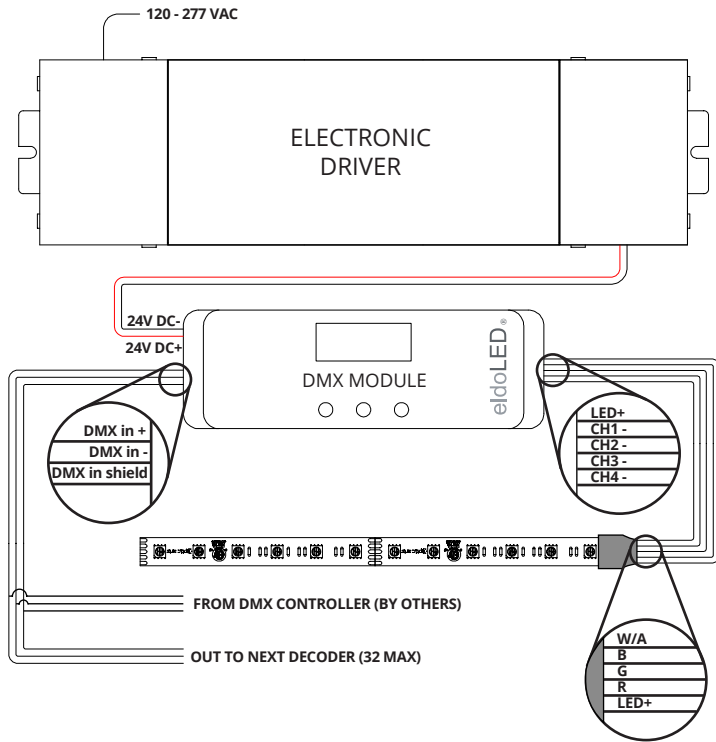

ELECTRONIC DRIVER W/DMX MODULE

PART	DESCRIPTION
GG100E-24-UNV-DMX	96W 120-277VAC ELECTRONIC DRIVER WITH eldoLED DMX DIMMING MODULE

DIMENSIONS

ELECTRONIC DRIVER - DMX MODULE	H 3.00"; W 11.46"; D 1.30"
DMX MODULE	H 1.97"; W 6.02"; D 0.91"

**Must be installed in UL box (by others)*

DIMMING PERFORMANCE

ELECTRONIC DRIVER - DMX MODULE	Dims to 0.1% on most DMX systems
--------------------------------	----------------------------------

COMPATIBLE DRIVERS

DIMMER WITH NEUTRAL

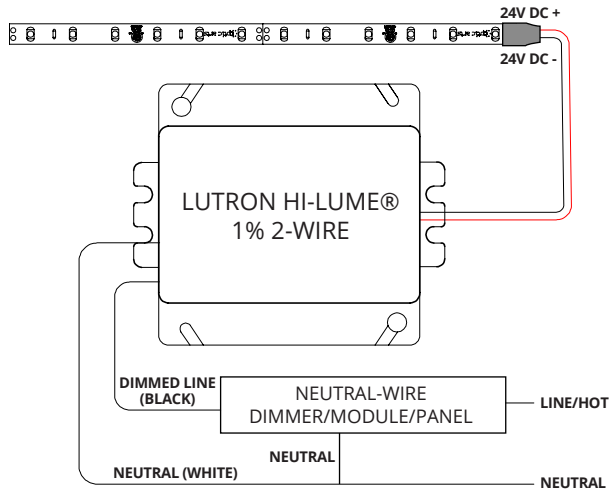

DIMMER WITHOUT NEUTRAL

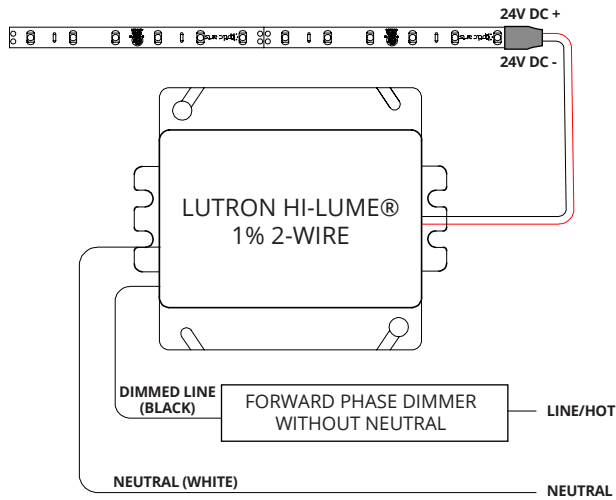

LUTRON HI-LUME® 1% 2-WIRE: 2-WIRE CONTROL FORWARD PHASE



PART	DESCRIPTION
LTEA4U1UKL-CV240	5-40W, 120VAC, 2-WIRE FORWARD PHASE DRIVER
DIMENSIONS	
HI-LUME® 1% 2-WIRE	H 4.00"; W 4.89"; D 2.62"
DIMMING PERFORMANCE	
LUTRON HI-LUME® 1% 2-WIRE	Dims to 1% with compatible Lutron controls

COMPATIBLE DRIVERS

3-WIRE

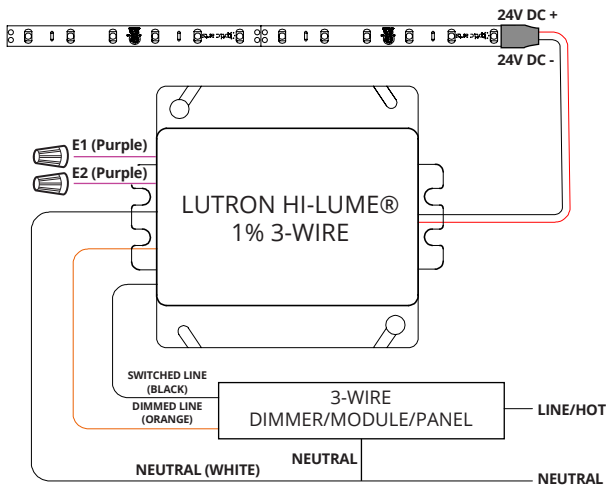

ECOSYSTEM

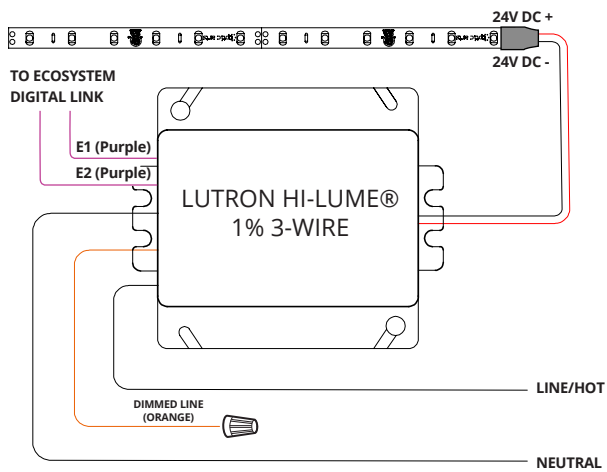

LUTRON HI-LUME® 1%: 3-WIRE/ECOSYSTEM



PART	DESCRIPTION
L3DA4U1UKL-CV240	5-40W, 120-277VAC, 3-WIRE/ECOSYSTEM DRIVER

DIMENSIONS	
HI-LUME® 1%	H 4.00"; W 4.89"; D 2.62"

DIMMING PERFORMANCE	
LUTRON HI-LUME® 1% 3-WIRE/ECOSYSTEM	Dims to 1% with compatible Lutron controls

COMPATIBLE DRIVERS

3-WIRE

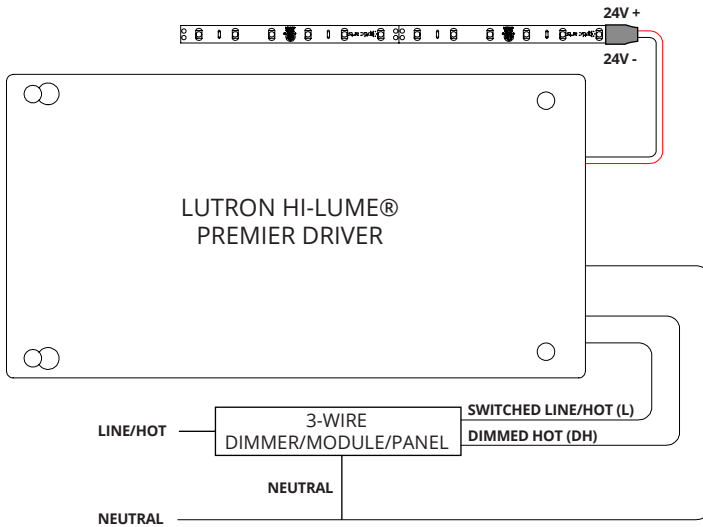

ECOSYSTEM

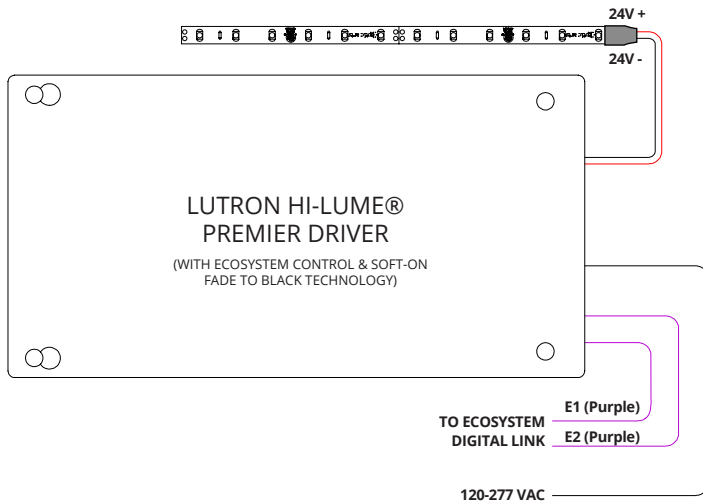

LUTRON HI-LUME® PREMIER: 3-WIRE/ECOSYSTEM



PART	DESCRIPTION
L3D0-96W24V-U	2-96W, 120-277VAC, 3-WIRE/ECOSYSTEM DRIVER

DIMENSIONS	
LUTRON HI-LUME® PREMIER	H 5.5"; W 10.5"; D 2.0"

DIMMING PERFORMANCE	
LUTRON HI-LUME® PREMIER	Dims to 0.1% with compatible Lutron controls
<i>NOTE: Lutron soft-on, fade to black technology available with Ecosystem Digital Control only.</i>	

REMOTE DRIVER DISTANCE CHART

NOTES:

1. Calculated using 4 amp draw (96 Watts at 24VDC).
2. Calculation includes 19.70" 22 AWG Flex Connect™ power feed wire connected to home run.

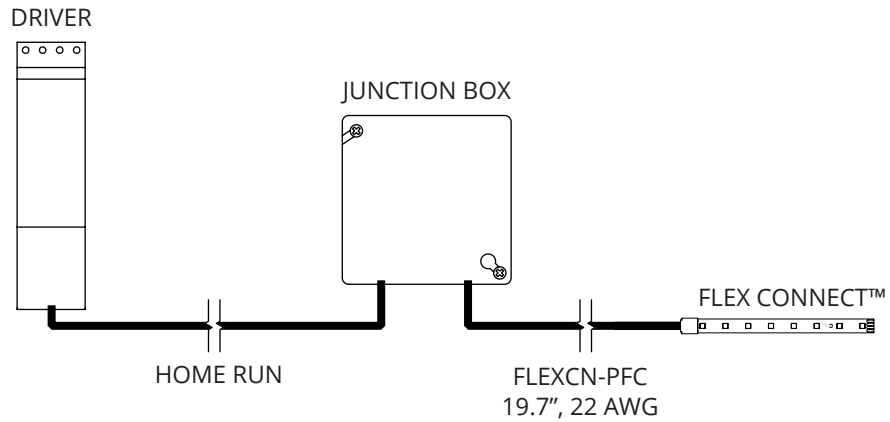

HOME RUN DISTANCE	MINIMUM GAUGE	VOLTS	% DROP
5'	20 AWG	23.40	2.49%
10'	18 AWG	23.30	2.94%
15'	16 AWG	23.40	2.82%
20'	14 AWG	23.40	2.49%
25'	14 AWG	23.30	2.92%
30'	12 AWG	23.43	2.395%
35'	12 AWG	23.37	2.66%
40'	12 AWG	23.30	2.93%
45'	10 AWG	23.45	2.31%
50'	10 AWG	23.41	2.48%
55'	10 AWG	23.37	2.64%
60'	10 AWG	23.33	2.81%
65'	10 AWG	23.29	2.98%
70'	8 AWG	23.46	2.28%
75'	8 AWG	23.43	2.38%
80'	8 AWG	23.41	2.49%
85'	8 AWG	23.38	2.59%
90'	8 AWG	23.36	2.70%
95'	8 AWG	23.33	2.80%
100'	8 AWG	23.31	2.91%