

# LETO 1 Single

ADJUSTABLE RECESSED LED DOWNLIGHT



**LETO 1 Single - Adjustable Recessed LED Downlight.** The LETO 1 Single is a square recessed LED fixture. Designed to be architecturally pleasing, it is fully adjustable to 30°. It can be used as a general light application, or to highlight specific design areas, or can do both using the LETO 1 double and triple option.

## Ordering Code

Fixture	<b>670</b>					
	1	2	3	4	5	6
Driver		<b>670</b>			--	--
	1	2	3	4	5	6

## Product Specifications

SAMPLE: Fixture **670 - A90 - 618 - 27 - 07 - 01** | Driver **910 - 670 - STD - 120 - A90 - 07**

1 - Model	2 - CRI/LED	3 - Optic	4 - CCT	5 - Lumen	6 - Finish	1 - Housing Style
<b>670</b> · Leto 1	<b>A90</b> · 93+ CRI Accuracy	<b>618</b> · 18° <b>630</b> · 30° <b>645</b> · 45° <b>660</b> · 60°	<b>25</b> · 2500K <b>27</b> · 2700K <b>30</b> · 3000K <b>35</b> · 3500K <b>40</b> · 4000K <b>65</b> · 6500K	<b>07</b> · 700 (8.2W) <b>10</b> · 1000 (12.1W) <b>15</b> · 1500 (16.4W) <b>20</b> · 2000 (24.9W) <b>30</b> · 3000 (31.8W)	<b>01</b> · White <b>02</b> · Black <b>08</b> · Silver <b>XX</b> · Custom	<b>910</b> · Remote <b>915</b> · New Construction
2 - Model	3 - Driver	Dim Level	Dim Level	4 - Voltage	5 - LED	6 - Lumen
<b>670</b> · Leto 1	<b>STD</b> · Non Dimming <b>LCS</b> · 0 - 10 Volt Protocol <b>DIM</b> · Phase <sup>*1</sup> <b>ELDOLC</b> · EidoLED 0 - 10 Volt <sup>*2</sup> <b>DALI</b> · Dali Protocol <sup>*2</sup>	N/A 1% 1% 0.1% 0.1%	<b>LUTES</b> · Hilume Ecodigital <sup>*2</sup> <b>LUT2W</b> · 2 Wire for phase <sup>*2</sup> <b>DMX</b> · SENSO <sup>*2</sup> <b>EMG</b> · Emergency Driver <sup>*2/3</sup> <b>CSMB</b> · Casambi Wireless Control <sup>*2/3</sup>	1% 1% 1% 1%	<b>120</b> · 120V <b>277</b> · 277V <b>347</b> · 347V <sup>*4</sup>	Same as Fixture Same as Fixture

\*1 120V only  
\*2 Requires remote housing  
\*3 Specified separately  
\*4 Not available with ELDO, Lutron or DMX

Project : \_\_\_\_\_  
Quantity : \_\_\_\_\_  
Type : \_\_\_\_\_  
Notes : \_\_\_\_\_



# LETO 1 Single

ADJUSTABLE RECESSED LED DOWNLIGHT



## Photometrics

Senso's in-house photometric testing ensures that our lighting design can match your needs precisely. Our Goniophotometer and testing lab produces on-demand photometry files based on any specified fixture, including LM-79 Test reports, IES Files, and CRI/CCT measurements. See [Sensolighting.com](http://Sensolighting.com) for more information.

*\*Full photometric Reports and IES files available for every configuration*

## Color Metrics

### TM 30-15

Our clients deserve the best information possible about their lighting choices. That's why Senso has invested in the Illuminating Engineering Society (IES) TM 30-15, a new system that measures an LED light source's color rendering properties. Using Senso's state-of-the-art goniophotometer, this method identifies the optimal light source for your project and helps evaluate the trade-offs between efficacy and color rendering. Senso can provide TM 30-15 data for all of our products.

*\*Full Color Metric Info Available at [Sensolighting.com](http://Sensolighting.com)*

## LED Module Performance

**Output:** Up to 93 lumen/Watt

**Efficacy:** Color consistency within a 3-MacAdam Ellipse

**CCT:** 2500K - 6500K

**Color Rendering:** 93+ CRI

**Min. R Values:** R<sup>9</sup> - 60 R<sup>f</sup> - 90 R<sup>9</sup> - 100

## Driver and Power Consumption

**Dimming:** 1% dimming standard with 0.1% option  
Casambi wireless control available

**Ripple:** Industry leading Low ripple

**Efficiency:** Power Factor >0.9  
Efficiency over 85%  
Class 2 output for safety

**Installation:** Remote mounted

Lumen Option	700lm	1000lm	1500lm	2000lm	3000lm
Fixture Wattage	8.2W	12.1W	16.4W	24.9W	31.8W
Delivered Lumen	765lm	1130lm	1452lm	2023lm	3002lm

## Installation

- For new and retrofit installations
- Holds in place with two spring clips
- Fully 30° angle adjustable spot, 360° rotation
- Simple connection between fixture and driver via quick connect
- Available wet rated in single version.

## Construction / Finish

- Custom finishes are available
- Cast Aluminum Trim and Steel Casing
- Rated for damp location
- Made in Canada

## Dimensions

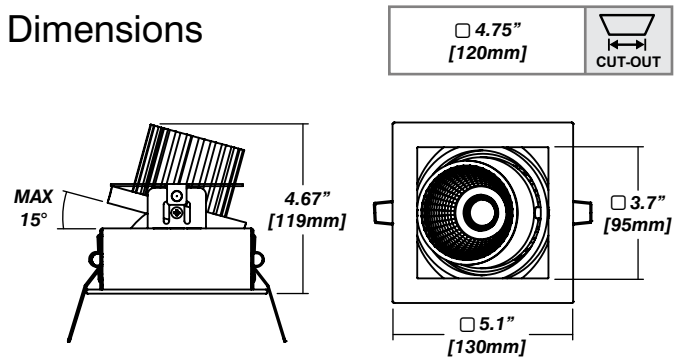

## Reflector

### Faceted Reflector

Senso metal spun reflectors for function, low glare and efficiency

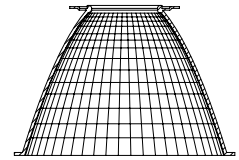

# LETO 1 Single

ADJUSTABLE RECESSED LED DOWNLIGHT  
Housing Options

## Standard Senso Housing - 910

### Dimension

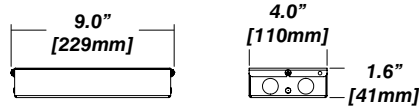
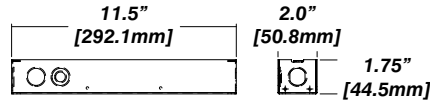
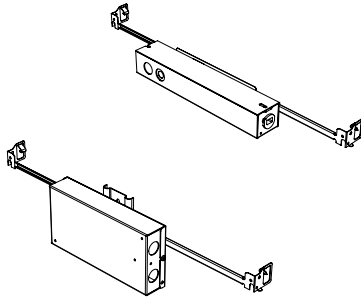

### Included

Unless specified otherwise, this is provided as standard

- Bar hanger** • Length: from 14-3/16" to 26"
- Driver with enclosure** • Galvanized steel enclosure
- Security wire** • Flexible aircraft cable, 12" long
- Easy to clip snap body included

\* driver can be installed either:

(A) laying on top of ceiling. (B) mounted to the bar hanger and fixed to the ceiling. (C) remote from the fixture, with the bar hanger still used if desired to secure the fixture

## New Construction - 915

### Dimension

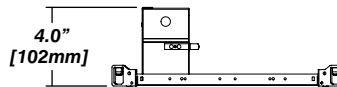
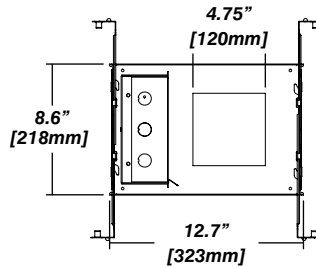
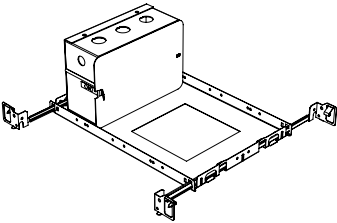

### Included

- Plaster Frame** • Galvanized steel construction with cut-out to
- Bar hanger** • Length: from 14-3/16" to 26"
- Security wire** • Flexible aircraft cable, 12" long
- Easy to clip snap body included