

# Plexineon Rings

## Catenary Mount

RGB, RGBW and RGBW Pixel

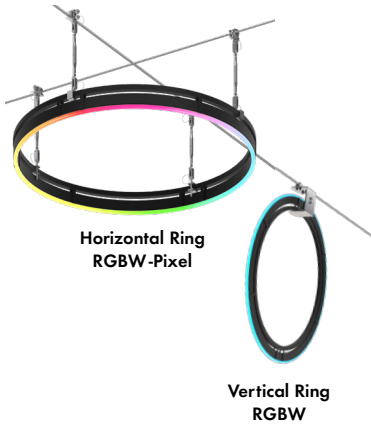

- For interior and exterior accent lighting
- Neon look providing a clear line of light visible for miles
- Includes Turnbuckles, Collar, Mounting Frame, Mounting Clips, and other hardware necessary to assemble to Catenary Cable
- Catenary Cable, Poles, Cable Eyes, and other Cable support hardware by others
- Operating Temperature: -40° F to 140° F (-40° C to 60° C)
- 24VDC Class 2
- IK10 and 3G rated
- IP67 rated. IP68 rating available upon specific request
- 5 year warranty indoor, 3 year warranty outdoor

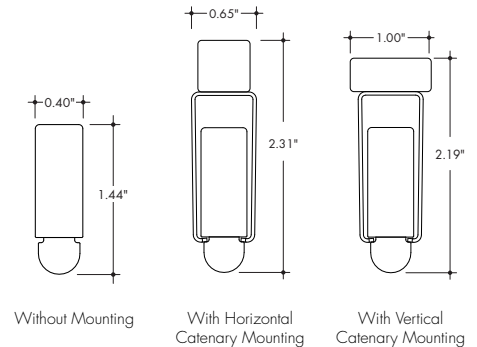

### Technical Information

RING OUTER DIAMETER* (inch)	Plexineon RGB	Plexineon RGBW	Plexineon Pixel RGBW
<b>EFFICACY</b>	17.5 lm/W	17.1 lm/W	14.7 lm/W
<b>Ø36 (Ø3ft)</b>	Lumen Output	679 lm	792 lm
	Power Consumption	38.6 W	53.7 W
<b>Ø72 (Ø6ft)</b>	Lumen Output	1357 lm	1583 lm
	Power Consumption	77.2 W	107.4 W
<b>Ø144 (Ø12ft)</b>	Lumen Output	2714 lm	3166 lm
	Power Consumption	154.6 W	214.9 W
<b>Ø288 (Ø24)</b>	Lumen Output	5429 lm	6333 lm
	Power Consumption	309.1 W	429.8 W

RGBW (3000K)				
Model	CRI	TM-30		
		R <sub>f</sub>	R <sub>g</sub>	R <sub>o</sub>
RGBW	85	84	98	22
RGBW-PXSPI	85	84	98	22

Dominant Wavelength	
Color	RGB
Red	622nm
Green	525nm
Blue	468nm

All channels full on.

\*Rings will be made of equal sections no longer than 96" arc length. Rings exceeding 96W will have allowances for additional power feeds.

### Ordering Code

MODEL	RING DIAMETER <sup>1</sup>	RING TYPE	CCT	OUTPUT	LENS	MOUNTING	FINISH	POWERFEED POSITION/TYPE
PX-Plexineon	___-Ring diameter in inches, 6"-144" (12ft)	HR-Horizontal Ring VR-Vertical Ring <sup>2</sup>	RGB-RGB RGBW-RGBW (3000K) RGBW-PXSPI-RGBW Pixel Control (3000K)	SO-Standard	F-Frosted	CD-Catenary Mount, Decorative Clips <sup>3</sup>	GG-Gloss Grey BK-Matte Black GY-Matte Grey WH-Matte White	B-4-Male Quick Connect One End, Female Quick Connect Other End

1. Rings will be made of equal sections no longer than 96" arc length. Tolerance on size of diameter is +/- 1".  
2. Vertical Ring max diameter is 72", min diameter is 24"

3. Catenary Mount fixtures include a fixture mounting frame and all mounting components necessary to attach to Catenary Cable (by others). 2 mounting clips included for every 12" of diameter, with a minimum of 3 clips. Mounting frames over dia48" are ship in multiple pieces and are assembled on site. Decorative Clips match the fixture finish.

# Plexineon Rings Catenary Mount

RGB, RGBW and RGBW Pixel



## Finish Options

**BK**  
Matte Black Finish

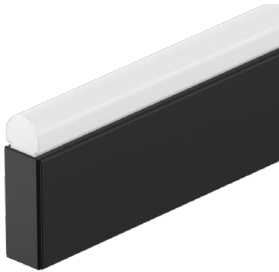

**WH**  
Matte White Finish



**GY**  
Matte Grey Finish

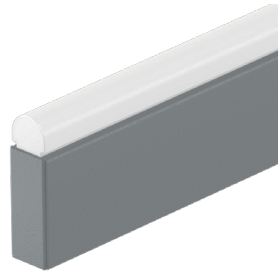

**GG**  
Gloss Grey Finish

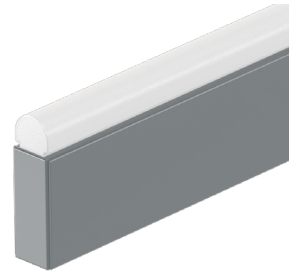

## Mounting Components

**CD**

Catenary Mount, Decorative Clip

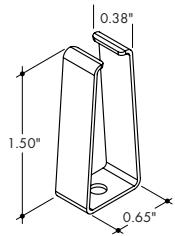

Thinner clip with finish options to match fixtures

Mounting Frame

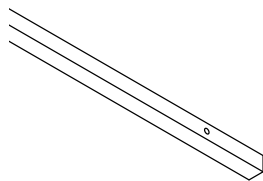

Mounting clips are riveted at the factory to the Mounting Frame. Finish matches Ordering Code Finish selected

Mounting Frame Joiner



Assembles Mounting Frame together for runs over 96" (8ft)

Adjustable Turnbuckle

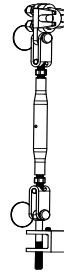

Able to adjust up to 2.5" vertically

Adjustable Collar

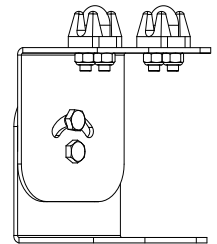

For vertical catenary rings

# Plexineon Rings Catenary Mount

RGB, RGBW and RGBW Pixel



## Powerfeed and Connectors

### For use with RGB

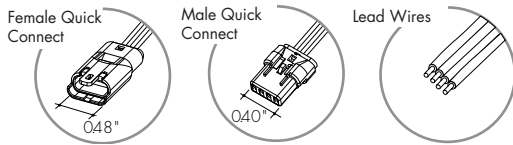

**60-H-C4-0001-01**  
Female RGB Quick Connect  
with 6" flying leads

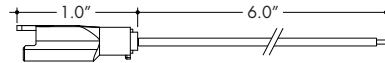

Female Quick Connect with flying leads can be connected to the Power Supply at the start of a run. Can also be used with the Male Quick Connect to make wire jumpers.

**60-H-C4-0002-01**  
Male RGB Quick Connect  
with 6" flying leads

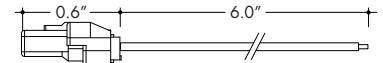

Male Quick Connect with flying leads can be used to make wire jumpers.

### For use with RGBW

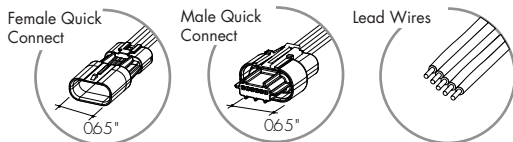

**60-H-C5-0001-01**  
Female RGBW Quick Connect  
with 6" flying leads

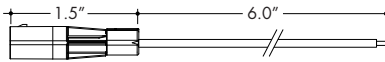

Female Quick Connect with flying leads can be connected to the Power Supply at the start of a run. Can also be used with the Male Quick Connect to make wire jumpers.

**60-H-C5-0002-01**  
Male RGBW Quick Connect  
with 6" flying leads

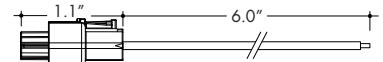

Male Quick Connect with flying leads can be used to make wire jumpers.

### For use with Pixel

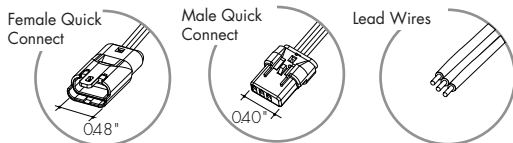

**60-H-C3-0001-01**  
Female Pixel Quick Connect  
with 6" flying leads

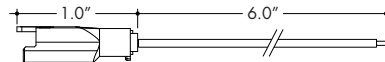

Female Quick Connect with flying leads can be connected to the Power Supply at the start of a run. Can also be used with the Male Quick Connect to make wire jumpers.

**60-H-C3-0002-01**  
Male Pixel Quick Connect  
with 6" flying leads

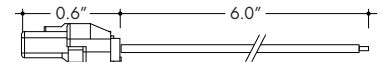

Male Quick Connect with flying leads can be used to make wire jumpers.

Also available with longer Flying Leads  
**60-H-C3-0005-01**  
Female Pixel Quick Connect  
with 384" flying leads

Also available with longer Flying Leads  
**60-H-C3-0006-01**  
Male Pixel Quick Connect  
with 384" flying leads

## Additional Material

**60-12-22AWGSBWN**  
Weatherproof Wire Nut  
Silicone Filled

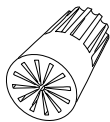

Order 2 per Power Supply.

**55-STW02-050-00**  
50 ft of 14 gauge wire Black jacket,  
2 conductors

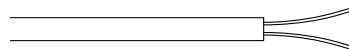

Sunlight, moisture resistant, and flame retardant PVC jacket per UL 1277

**70-TOL02-001-01**

Mounting Clip Installation Tool

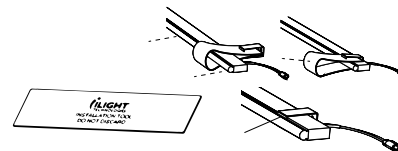

Use for installation of Plexineon into Mounting Clips

# Plexineon Rings

## Catenary Mount

RGB, RGBW and RGBW Pixel



### Ring Types

**HR**  
Horizontal Ring

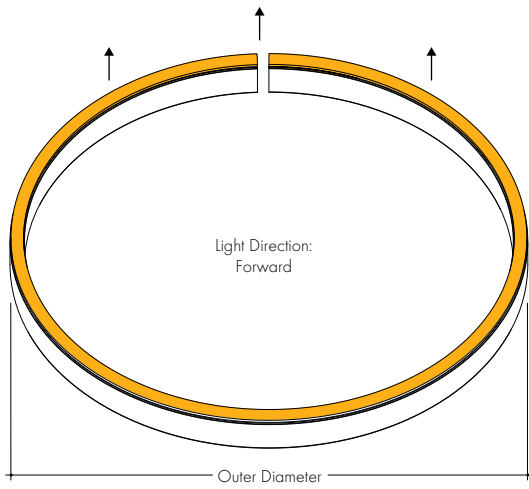

**VR**  
Vertical Ring

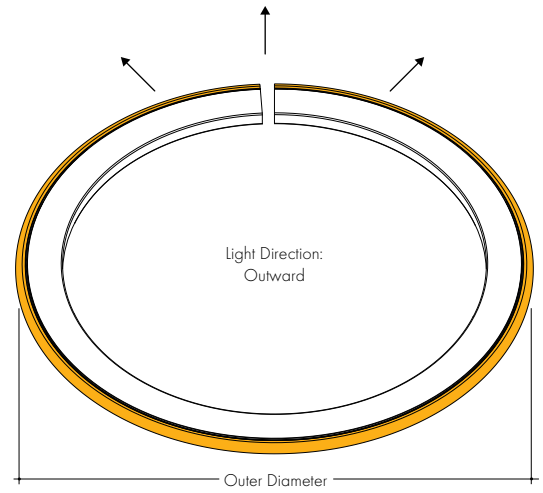

# Plexineon Rings Catenary Mount

RGB, RGBW and RGBW Pixel



## Sample Layout

**PX-72-HR-RGBW-PXSPI-SO-F-CD-GG-B-4**

Plexineon Horizontal Ring, Catenary Mount, Decorative Clips

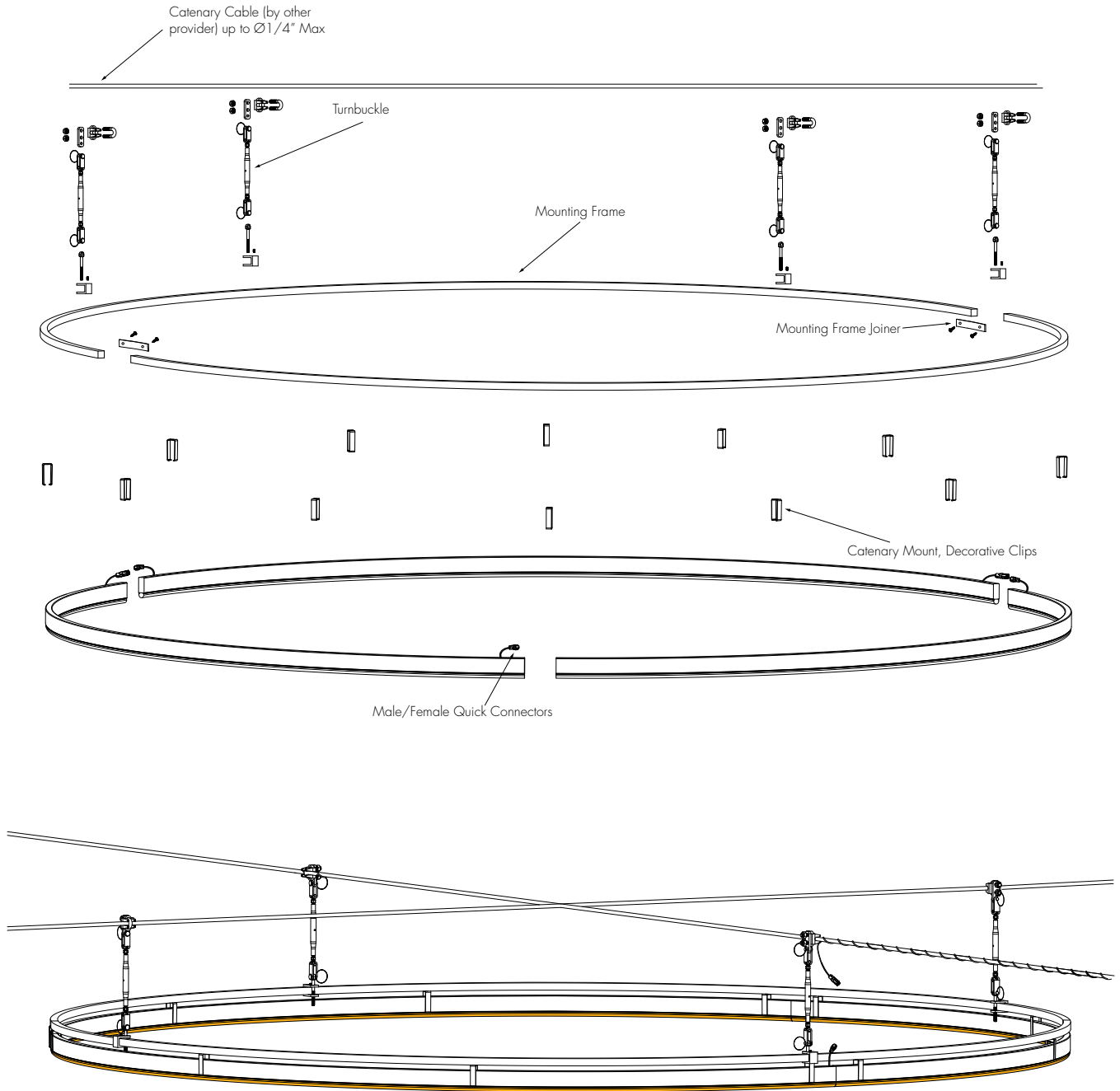

# Plexineon Rings

## Catenary Mount

RGB, RGBW and RGBW Pixel



### Sample Layout

- Horizontal Ring

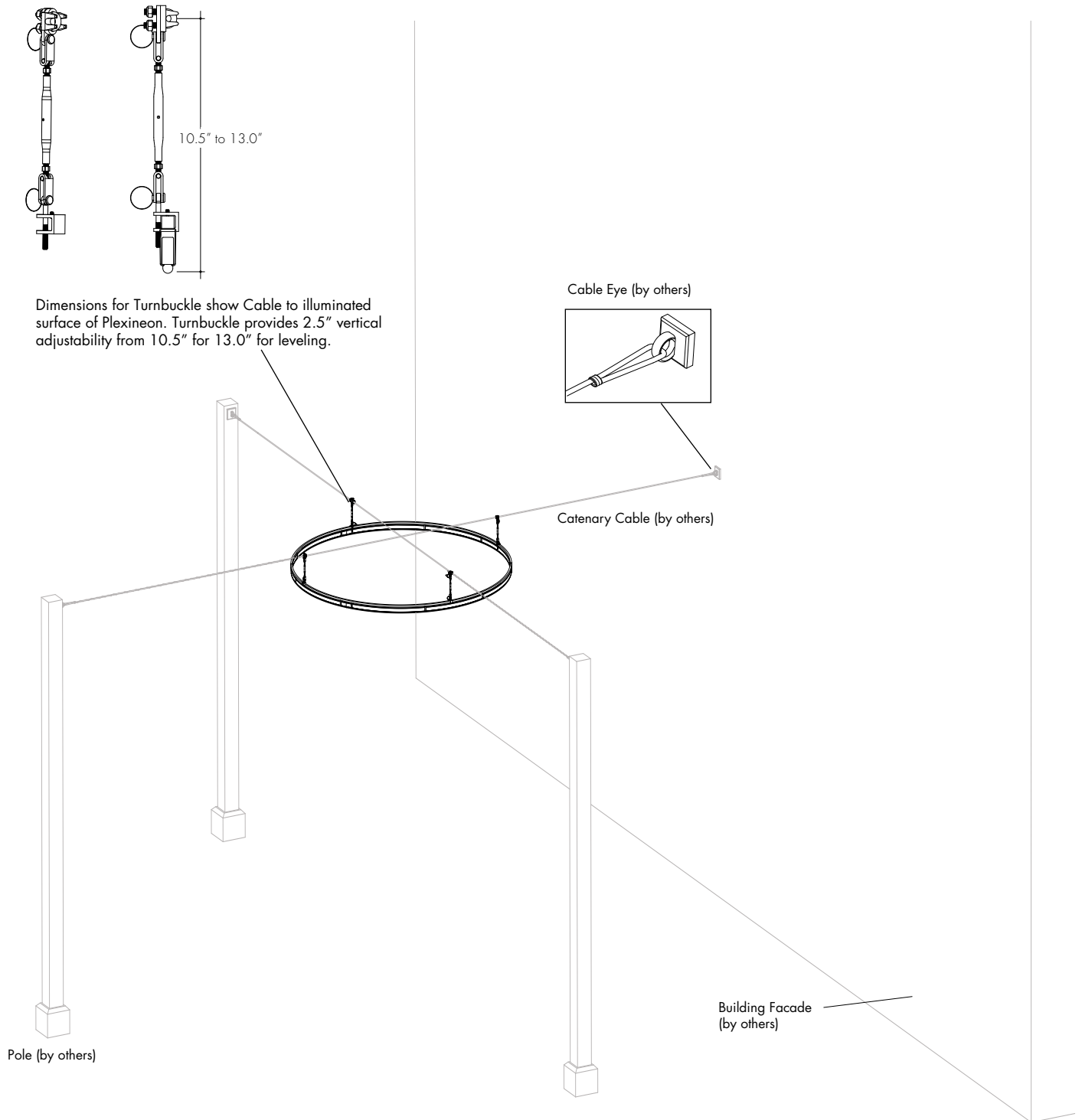

# Plexineon Rings

## Catenary Mount

RGB, RGBW and RGBW Pixel

### Sample Layout

**PX-36-VR-RGBW-PXSPI-SO-F-CD-GG-B-4**

Plexineon Vertical Ring, Catenary Mount, Decorative Clips

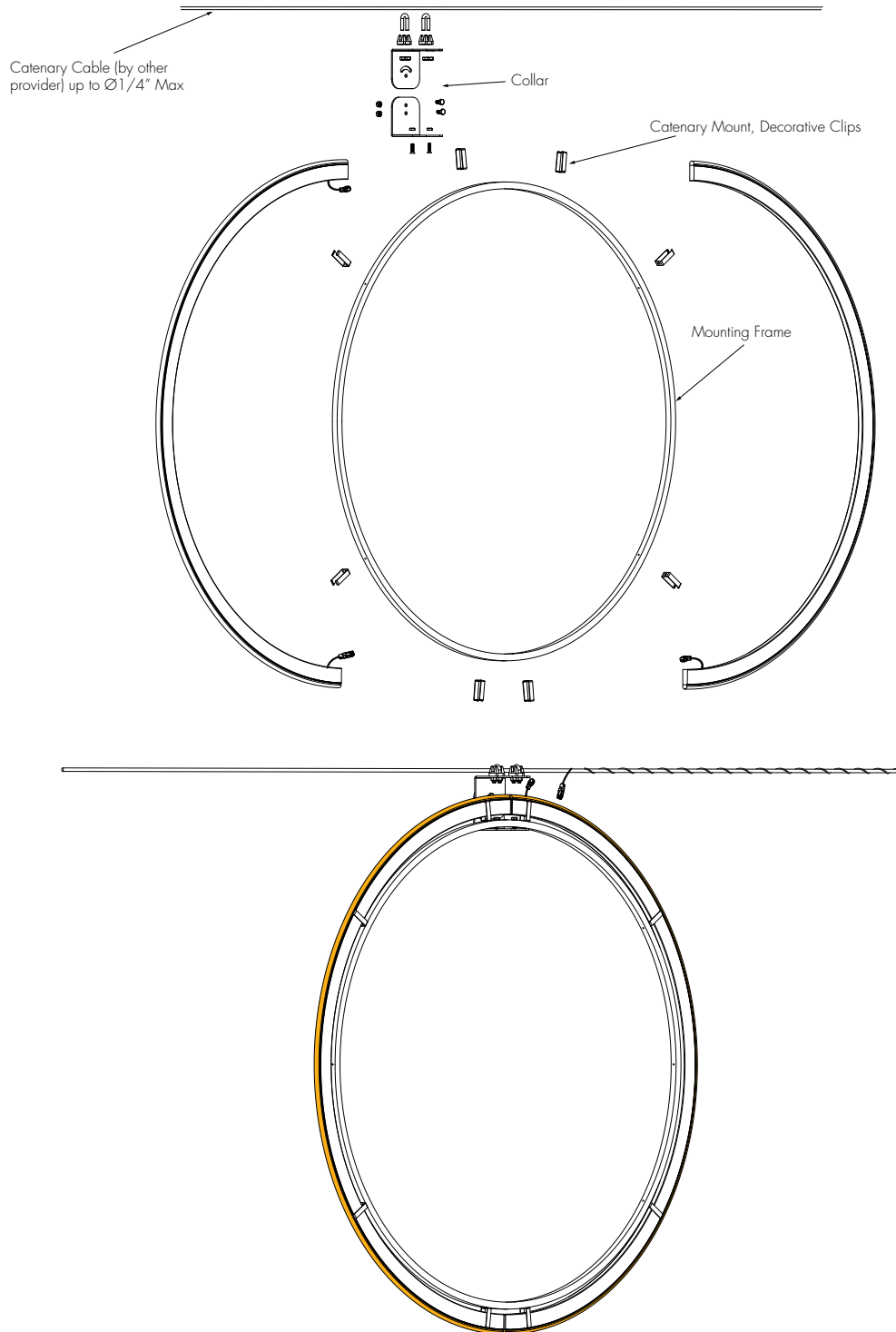

# Plexineon Rings Catenary Mount

RGB, RGBW and RGBW Pixel

## Sample Layout

- Vertical Ring

Collar provides up to 45° angular adjustability.  
1 Collar per each plexineon vertical ring.

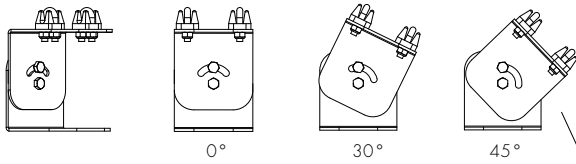
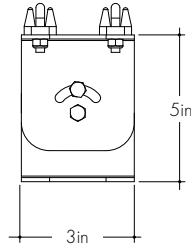

Cable Eye (by others)

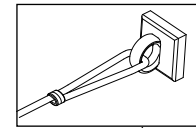

Catenary Cable (by others)

Building Facade (by others)

Pole (by others)



# Plexineon Rings Catenary Mount

RGB, RGBW and RGBW Pixel



ilight  
by luminii

## Common Applications

Custom Indoor Designs | Coves | Signs | Building Facades | Lobbies | Hallways | Statement Pieces | Restaurants  
Corporate Offices | Schools | Residential Towers | Parking Garages | Hotels | Bridges | Benches | Airports



# Plexineon Rings Catenary Mount

RGB, RGBW and RGBW Pixel

## Power Supplies

See fixture and power supply instructions & spec sheet for wiring information. Dimming possible in select models - view luminii website for list of compatible dimmers.

### For use with RGB/RGBW/Pixel

#### Non-Dimming Power Supply 120VAC - 277VAC

MODEL	POWER	OUTPUT	DIMMING	LOCATION
PSV-PSV Series	96-96 Watt	24-24 VDC	ND-Non Dimming	D-Dry location

Requires a controller and a decoder to work properly

MODELS	96W
Length	8.25"
Width	4.10"
Depth	1.56"

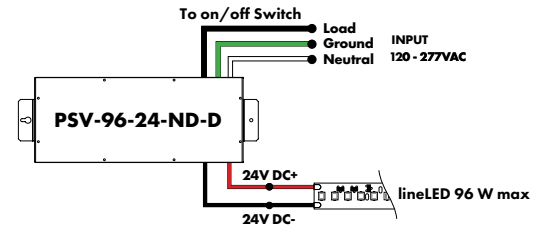

### For use with RGB/RGBW

#### DMX 0% Dimming Power Supplies 120VAC - 277VAC

MODEL	POWER	OUTPUT
PSDMX-DMX Power Supply dims down to 0%	96 - 96 Watt 3X96 - 3 X 96 Watt	24-24 VDC

Features eldoLED's LINEARdrive configurable dimmable drivers.

DDMX-RGBW DMX Decoder not required when purchasing this power supply.

MODELS	96W	3X96
Length	14.40"	15.75"
Width	5.20"	6.62"
Depth	2.60"	4.95"

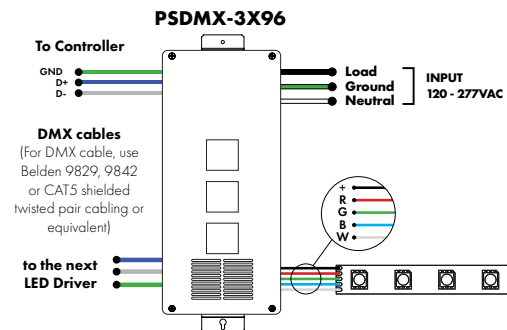
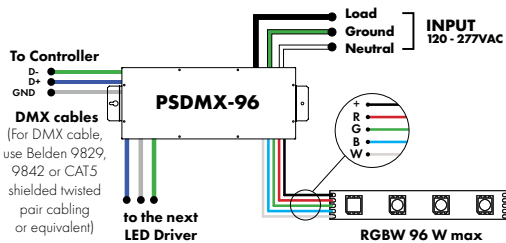

# Plexineon Rings Catenary Mount

RGB, RGBW and RGBW Pixel



## DMX-1Z-RGBW, DMX-3Z-RGBW

RGBW LED 1 or 3 Zone Controller



ORDERING CODE

MODEL	ZONES	COLOR
DMX - DMX Controller	3Z - Three Zone 1Z - One Zone	RGBW - Red, Green, Blue, & White

DMX /Wireless RGB-W wall-mount controller controls DMX lighting fixtures, wireless control of RGB-W lighting fixture or use both simultaneously. Fits in any standard US switch box. Includes all the outputs in the back of the controller.

Control brightness levels with a single touch, personalize and memorize 3 different scenes, and even create 3 variations of white.

### Features

- 2 in 1 in-Wall Controller: DMX Control or Wireless RGB-W
- 65,000 Color Options, Dimming and Speed Control
- Memory Function
- 50 Foot Wireless Range
- Easily Fits Standard US Switch Boxes
- Touch Sensitive Glass Surface
- Includes 10 Built in Programs, or Create and Play Your Own

### Operating Voltage

12 - 24V DC

### Color Parameters

- Brightness
- Saturation
- Primary colors
- Fading
- Color changing speed

## Touch DMX Controller

Touchscreen digital LED controller

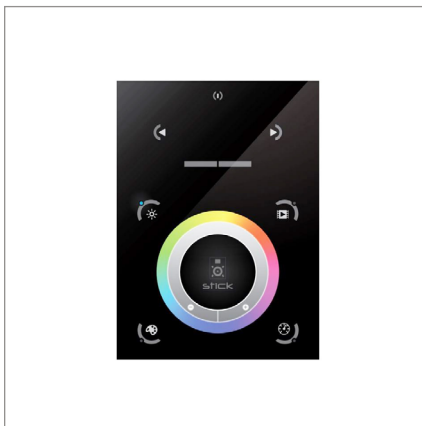

ORDERING CODE

MODEL
TSDMX-E

TSDMX-E - Touchscreen DMX controller

Programmable advanced DMX512 lighting controller featuring a touch-screen interface. Operates as stand alone controller or integrated with most architectural lighting control systems. Can controller endless DMX512 enabled devices.

Mounts to standard single or dual gang wall box with the included power supply inside the junction box. Terminal block design for power and data connections.

### Features

- Sleek glass design which sits 0.43" from the wall
- Graphical color display to show selected environment
- Color/dimmer/speed palette
- Color temperature mixing
- Touch sensitive buttons. No mechanical parts
- Touch sensitive wheel allows for accurate color selection
- Multi-zone microSD memory
- Multi-room control with 500 scenes, 10 zones
- 1024 DMX channels. Control 340 RGB fixtures
- USB & Ethernet connectivity for programming and control

### Power Supply

7 VDC (included)

### Programmability

PC, Mac, Tablet, Smartphone

### Output Signal

DMX512 (1024 channels)

### Color Parameters

- Brightness
- Saturation
- Speed of color changing sequence
- Fading / dimming / brightness

# Plexineon Rings Catenary Mount

RGB, RGBW and RGBW Pixel

## DMX Decoder

DMX signal to RGBW decoder (required to operate DMX controller)

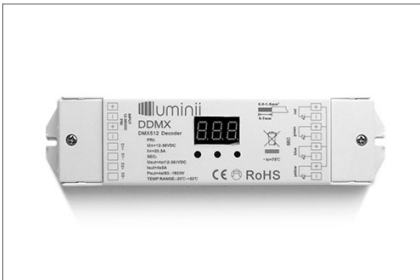

ORDERING CODE

MODEL

**DDMX-RGBW**

DDMX-RGBW - DMX decoder

Translates controller DMX512 programs for RGB and white LED strips.

Unique DMX address for the decoder can be set easily and displayed by the numeric display on the case. Changing and resetting the DMX address requires manual input.

Use power repeater to expand output.

### Operating Voltage

12-36 VDC

### Power Capacity

up to 96W at 24V

### Operating Temperature Range

from -4°F to +122°F in case

## Smart Pixel Decoder

SPI signal to DMX signal decoder



ORDERING CODE

MODEL

**SR-DMX-SPI**

SR-DMX-SPI - Smart Pixel Decoder

The SR-DMX-SPI is a smart LED pixel decoder that controls RGB/RGBW pixel LED strips with SPI signal. Designed with an OLED backlit panel, the pixel controller allows for easy configuration of most settings. Four push buttons are available for control of the LED functions.

\* For pixel only.

### Features

- 2 in 1 in-Wall Controller: DMX Control or Wireless RGB-W
- SPI signal output for RGB/RGBW pixel light control
- DMX512 controllable and RF/WIFI remote controllable
- Capable of addressing up to 1020 RGB pixels & 765 RGBW pixels
- OLED panel allows for easy configuration

### Operating Voltage

12 - 36V DC

### Power capacity

up to 96W at 24V

### Operating temperature range

from -4°F to +122°F in case