

Features

LLRGBW36 is a small profile LED strip incorporating 4 discrete emitters in each LED - red, green, blue, and 3000K white. Increased pitch provides more continuous light, while a High Output option offers incredible brightness. 36 LEDs per foot. Luminii attention to color quality provides balanced output across the color gamut, as well as true, balanced white.



Mounting

LED strip is equipped with 3M™ adhesive transfer tape (9472LE).

Applications

Indoor only - millwork, cove, architectural reveals, undercabinet, display case, handrail, accent lighting.

Approvals

Class 2 damp listed

Operating voltage

24 VDC

Life (L70)

50,000 hours

Warranty

5 years

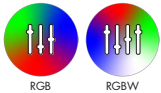

Technical Specifications

TYPE	LLRGBW36	
OUTPUT OPTIONS	SO	HO
Lumens Output (all channels full on)	212 lm/ft	351 lm/ft
Average Power Consumption (for a 4' section)	4 W/ft	7.6 W/ft
Cutting Increment (in)	1.97"	
Pitch Length	0.33"	
Efficacy	53 lm/W	46 lm/W
Max Run Length (in series)	26 ft	13 ft
Dimensions	0.39" W x 0.07" H	

RGBW (3000K)

Tape	CRI	TM-30		
		R _f	R _g	R ₉
LLRGBW36-SO	95	94	106	82
LLRGBW36-HO	95	93	106	84

Color	Dominant Wavelength	RGBW36SO	RGBW36HO
Red	620nm	35 lm/ft	63 lm/ft
Green	525nm	95 lm/ft	164 lm/ft
Blue	467nm	21 lm/ft	33 lm/ft
White	NA	67 lm/ft	110 lm/ft

Section Start/End Options

SL

Soldered lead wires (72")



NC

No connector

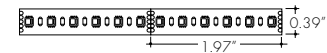

LF

Lead Female 3" cable

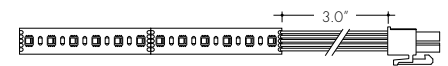

LM

Lead Male 3" cable

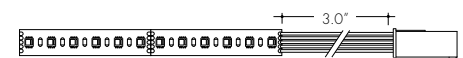

Ordering Code

MODEL	OUTPUT	SECTION START	SECTION END	LENGTH
LLRGBW36 - Line LED LLRGBW36 Red, green, blue, and white	SO - Standard HO - High	SL - Soldered lead wires (72") LF - Female Quick Connect LM - Male Quick Connect NC - No Connector	SL - Soldered lead wires (72") LF - Female Quick Connect LM - Male Quick Connect NC - No Connector	Ordered in one foot increments. See chart above for max run length.

Accessories

CL1
Mounting clip

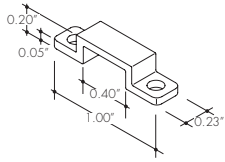

LL.ZIP
Cable/Wire Strain Relief Clip

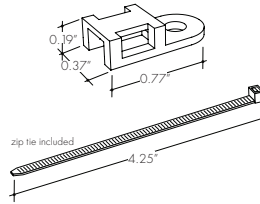

Recommended every 12" when LineLED strip is facing down

Lens Options / Light Transmission

C Clear	HF Half (50%) Frosted	GR Graze	F Frosted	FF Flat Frosted	R Raised	S Square Frosted	Q Round Square Frosted	13° 13° Semi-Frosted
BOS Channel (BOSC-XX) 	CLA Channel (CLAC-XX) 	MCAL Channel (MCALC-XX) 	K45V Channel (K45V-XX) 					
F 52% SI 66% R 60% G 76%	S 62% Q 65%	C 94%	C 82% HF 68% F 45% 13° 75%					
K45R Channel (K45R-XX) 	KiloR Channel (KILORC-XX) 	Kilo Channel (KILOC-XX) 	KL Channel (KLC-XX) 					
RF 61%	C 85% F 75%	C 85% F 75%	C 81% HF 67% F 51%					
KRL Channel (KRLC-XX) 	KM Channel (KMC-XX) 	KRM Channel (KRMC-XX) 	KS Channel (KSC-XX) 					
C 81% HF 67% F 51%	C 82% HF 68% F 45% FF 52% R 58% GR 57%	C 82% HF 68% F 45% FF 52% GR 57%	C 86% HF 71% F 56% FF 60% R 85% M 64%					
KRS Channel (KRSC-XX) 	KXL Channel (KXLC-XX) 	KRXL Channel (KRXLC-XX) 	RO15 Channel (RO15-XX) 					
C 86% HF 71% F 56% FF 60% M 64%	C 81% HF 67% F 51%	C 81% HF 67% F 51%	C 65% F 41%					

Led Dotting per Extrusion

using the frosted lens option

Extrusion	LLRGBW36
KSC, KRSC	CD
KMC, KRMC, K45VC, K45RC	ND
KXLC, KRXLC	ND
KLC, KRLC	ND
RO	ND
BOSC	ND
CLAC	ND
KILOC, KILORC	ND

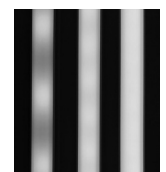

CD SD ND
CD - Clear Dotting
SD - Slight Dotting
ND - No Dotting

Installation

All mounting channels are field cuttable using miter saw with circular blade suitable for cutting aluminum.

Ordering

Extrusions are sold separately. View respective specsheets for details on ordering extrusions and their accessories (endcaps, mounting brackets, etc).

Power Consumption

Tested at full power with PDC Series power supplies.

LLRGBW36				
Nominal Length	SO		HO	
	W/ft	Total wattage	W/ft	Total wattage
1	4.0	4.0	7.3	7.3
2	3.6	7.3	7.2	14.5
3	3.8	11.0	7.3	21.3
4	3.9	15.1	7.4	28.8
5	3.8	18.9	7.3	35.9
6	3.9	23.5	7.4	44.8
7	3.9	27.4	7.3	51.9
8	3.8	30.8	7.2	57.2
9	3.8	34.0	6.8	61.4
10	3.9	38.6	6.9	68.7
11	3.8	41.9	6.8	74.8
12	3.8	45.5	6.6	79.2
13	3.7	48.6	6.4	83.0
14	3.7	51.8		
15	3.7	54.6		
16	3.6	58.1		
17	3.5	60.3		
18	3.5	63.6		
19	3.5	65.7		
20	3.4	68.2		
21	3.4	71.4		
22	3.3	73.1		
23	3.2	73.9		
24	3.1	75.2		
25	3.2	78.6		
26	3.1	79.5		

Voltage Drop Calculator

The below chart assumes nominal voltage of 24 Volts and a Voltage Drop Allowance of 3% through the wire

Wattage [W]	Maximum Wire Length From Power Supply to Start of Run [ft]						
	12 AWG	14 AWG	16 AWG	18 AWG	20 AWG	22 AWG	24 AWG
5	1088.2	684.4	430.3	270.6	170.2	107.1	67.3
10	544.1	342.2	215.1	135.3	85.1	53.5	33.7
15	362.7	228.1	143.4	90.2	56.7	35.7	22.4
20	272.0	171.1	107.6	67.7	42.6	26.8	16.8
25	217.6	136.9	86.1	54.1	34.0	21.4	13.5
30	181.4	114.1	71.7	45.1	28.4	17.8	11.2
35	155.5	97.8	61.5	38.7	24.3	15.3	9.6
40	136.0	85.5	53.8	33.8	21.3	13.4	8.4
45	120.9	76.0	47.8	30.1	18.9	11.9	7.5
50	108.8	68.4	43.0	27.1	17.0	10.7	6.7
55	98.9	62.2	39.1	24.6	15.5	9.7	6.1
60	90.7	57.0	35.9	22.6	14.2	8.9	5.6
65	83.7	52.6	33.1	20.8	13.1	8.2	5.2
70	77.7	48.9	30.7	19.3	12.2	7.6	4.8
75	72.5	45.6	28.7	18.0	11.3	7.1	4.5
80	68.0	42.8	26.9	16.9	10.6	6.7	4.2
85	64.0	40.3	25.3	15.9	10.0	6.3	4.0
90	60.5	38.0	23.9	15.0	9.5	5.9	3.7
96	56.7	35.6	22.4	14.1	8.9	5.6	3.5

Power Supplies

See fixture and power supply instructions & spec sheet for wiring information. Dimming possible in select models - view Luminii website for list of compatible dimmers.

DMX Dimming Power Supplies 120VAC - 277VAC

MODEL	POWER	OUTPUT
PSDMX - DMX Power Supply dims down to 0%	96 - 96 Watt 3X96 - 3 X 96 Watt	24 - 24 VDC

Features eldoLED's LINEARdrive configurable dimmable drivers
*With controller only

MODEL	96W	3X96
Length	14.40"	13.00"
Width	5.20"	6.62"
Depth	2.60"	4.20"

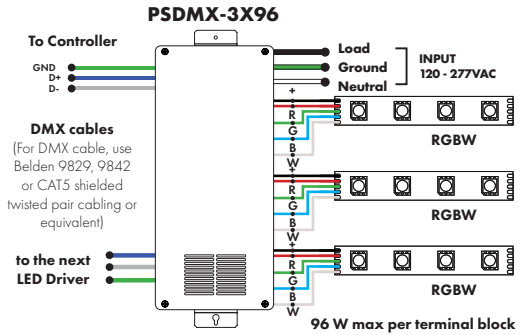
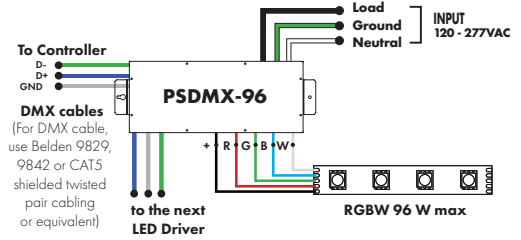

Non-Dimming Power Supply 120VAC - 277VAC

MODEL	POWER	OUTPUT	DIMMING	LOCATION
PSV - PSV Series	96 - 96 Watt	24 - 24 VDC	ND - Non Dimming	D - Dry location

Requires a controller and a decoder to work properly

MODELS	96W
Length	8.25"
Width	3.75"
Depth	1.63"

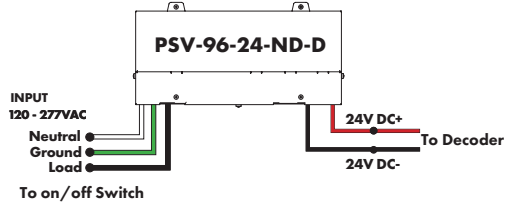

Decoders



DMX512 decoder with RDM functionality features 5 PWM output channels with common anode. High PWM output frequency range allows the product to be used in HD video conferencing spaces. All DMX products to be installed per DMX512 Standard.

Power
96 Watt

Inputs
RJ45, XLR-5Pin, Terminal Block

DMX Channels
1 to 5 settable

PWM Output Resolution Ratio
8 or 16 bit

PWM Output Frequency
500Hz - 30KHz

Output Dimming Curve Gamma Value
0.1 ~ 9.9

MODEL

DDMX-5CH-RDM-PRO

DDMX-5CH-RDM-PRO-DMX512 Decoder

Decoders



MODEL

DDMX-RGBW

DDMX-RGBW - DMX512 Decoder

Translates controller DMX512 programs for RGB and white LED strips.

Unique DMX address for the decoder can be set easily and displayed by the numeric display on the case. Changing and resetting the DMX address requires manual input.

Use power repeater to expand output (Luminii part# RGBW-SR).

Operating Voltage
12-36 VDC

Power Capacity
up to 96W at 24V

Operating Temperature Range
from -4°F to +122°F in case

PWM Output Frequency
200Hz or 1500Hz



MODEL

RGBW-MC3

RGBW-MC3 - 4-zone RGBW controller

Easy to operate wireless interface suitable for static or color changing scenes. Control 4 different color zones separately or at the same time. RGBW receiver (RGBW-RC-R) required for operation. Assign multiple receivers per zone to cover a large area.

Color wheel enables highly stable and sensitive color control functionality. Create your own color changing sequences with ease and flexibility.

Power
qty 3 AAA batteries

Scenes
up to 4 unique zones

Signal
Wireless (RF)

Energy Saving
Deactivates after 10 seconds of inactivity

Color Parameters

- Brightness
- Saturation
- Primary colors
- Speed of color changing sequence
- Fading



MODEL

RGBW-RC-R

RGBW-RC-R - RGBW receiver

The RGBW receiver is easily paired with controller by the click of a button. Receiver can be reset to factory settings at any time.

Each receiver can store one static RGB color, one color sequence, and one brightness setting for the white LED strip. Receivers assigned to the same scene within the same zone will have the same LED static color and color sequence.

Operating Voltage
12-36 VDC

Power Capacity
up to 96W at 24V

Operating Temperature Range
from -4°F to +122°F in case

Decoders



MODEL

RGBW-SR

RGBW-SR - RGBW signal repeater

Extends identical signal when connected in series to an RGBW LED control system. The RGBW signal repeater works with Luminii RGB and RGBW controllers, receivers, and decoders.

RGBW signal can be extended indefinitely when adequate power supply (not included) is connected to the system.

Operating Voltage
12-36 VDC

Power Capacity
up to 96W at 24V

Operating Temperature Range
from -4°F to +122°F in case



MODEL

RGBW-Wi-R

RGBW-Wi-R - WiFi generator

RGBW-Wi-R creates a local network that enables any electronic device (phone, tablet, etc.) to control the RGB/W strip connected to a RGBW-RC-R receiver.

The control functions are achieved through a free application download for Android and iOS devices called REALCOLOR.

Operating Voltage
12-36 VDC

Power Supply
PI-130-24 (included)

Operating Temperature Range
from -4°F to +122°F in case

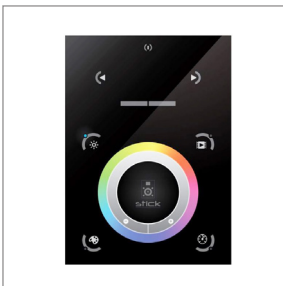

MODEL

TSDMX-E

TSDMX-E - Touchscreen DMX controller

Programmable advanced DMX512 lighting controller featuring a touch-screen interface. Operates as stand alone controller or integrated with most architectural lighting control systems. Can controller endless DMX512 enabled devices.

Mounts to standard single or dual gang wall box with the included power supply inside the junction box. Terminal block design for power and data connections.

Features

- Sleek glass design which sits 0.43" from the wall
- Graphical color display to show selected environment
- Color/dimmer/speed palette
- Color temperature mixing
- Touch sensitive buttons. No mechanical parts
- Touch sensitive wheel allows for accurate color selection
- Multi-zone microSD memory
- Multi-room control with 500 scenes, 10 zones
- 1024 DMX channels. Control 340 RGB fixtures
- USB & Ethernet connectivity for programming and control

Power Supply

7 VDC (included)

Programmability

PC, Mac, Tablet, Smartphone

Output Signal

DMX512 (1024 channels)

Color Parameters

- Brightness
- Saturation
- Speed of color changing sequence
- Fading / dimming / brightness

Decoders

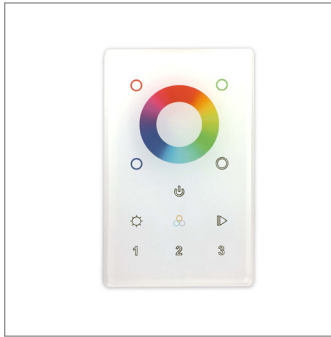

DMX /Wireless RGB-W wall-mount controller controls DMX lighting fixtures, wireless control of RGB-W lighting fixture or use both simultaneously. Fits in any standard US switch box. Includes all the outputs in the back of the controller. Control brightness levels with a single touch, personalize and memorize 3 different scenes, and even create 3 variations of white.

Features

- 2 in 1 in-Wall Controller: DMX Control or Wireless RGB-W
- 65,000 Color Options, Dimming and Speed Control
- Memory Function
- 50 Foot Wireless Range
- Easily Fits Standard US Switch Boxes
- Touch Sensitive Glass Surface
- Includes 10 Built in Programs, or Create and Play Your Own

Operating Voltage

12 - 24V DC

Color Parameters

- Brightness
- Saturation
- Primary colors
- Fading
- Color changing speed

MODEL	ZONES	COLOR
DMX-DMX	3Z-3 Zone 1Z-1 Zone	RGBW-Red, Green, Blue, & White