

# LETO 44 S A LRG

ASYMMETRIC SURFACE MOUNT LED DOWNLIGHT



**Leto 44 S A LRG - Surface LED Downlight.** Leto 44 S A LRG is the asymmetric version of Leto 44 S LRG. Solid, sticking and bold, Leto 44 S A LRG is the flagship size of the Leto 44 Range. Its tall and slender figure mixed with hard lines will make a statement in any space. Leto 44 S A LRG will **NOT** fit over a standard junction box. Requires client supplied reducer ring (TNB 54 C 3) for installation.

## Ordering Code

Fixture	<b>705A</b>		--					
	1	2	3	4	5	6	7	8
Driver				--	--			
	1	2	3	4	5			

## Product Specifications

SAMPLE: Fixture **705A - A90 - --- 27 - 07 - DL - 08 - 01** | Driver **910 - STD - 120 - A90 - 07**

1 - Model	2 - LED	3 - Optic	4 - CCT	5 - Lumen	6 - Accessory	7 - Body Color
<b>705A</b> · Leto 44 Large Asymmetric Surface Mount	<b>A90</b> · 93+ CRI Accuracy	<i>Leto 44 A is equipped with a fixed beam spread. For other optics please contact SENSO.</i>	<b>25</b> · 2500K <b>27</b> · 2700K <b>30</b> · 3000K <b>35</b> · 3500K <b>40</b> · 4000K <b>65</b> · 6500K	<b>07</b> · 700 (6.1W) <b>10</b> · 1000 (9.1W) <b>15</b> · 1500 (14W)	<b>DL</b> · Diffusing Lens	Standard <b>01</b> · White <b>02</b> · Black <b>08</b> · Silver  Premium <b>52</b> · Mocha <b>53</b> · Charcoal <b>54</b> · Cerulean <b>55</b> · Firebrick <b>XX</b> · RAL

8 - Baffle Color	1 - Housing	2 - Driver	Dim Level	Dim Level
Standard <b>01</b> · White <b>02</b> · Black <b>08</b> · Silver  Premium <b>52</b> · Mocha <b>53</b> · Charcoal <b>54</b> · Cerulean <b>55</b> · Firebrick <b>XX</b> · RAL	<b>00</b> · Integral Driver <b>910</b> · Remote Driver Housing	<b>STD</b> · Non Dimming <b>LCS</b> · 0 - 10 Volt Protocol <b>DIM</b> · Phase <sup>*1/2</sup> <b>ELDOLC</b> · EldoLED 0 - 10 Volt <sup>*2</sup> <b>DALI</b> · Dali Protocol <sup>*2</sup>	N/A 1% 1% 0.1% 0.1%	<b>LUTES</b> · Hilume Ecodigital <sup>*2</sup> 1% <b>LUT2W</b> · 2 Wire for phase <sup>*1/2</sup> 1% <b>DMX</b> · SENSO <sup>*2</sup> <b>EMG</b> · Emergency Driver <sup>*2/3</sup> <b>CSMB</b> · Casambi Wireless Control <sup>*2/3</sup>

3 - Voltage	4 - LED	5 - Lumen
<b>120</b> · 120V <b>277</b> · 277V <b>347</b> · 347V <sup>*2/4</sup>	Same as Fixture	Same as Fixture

\*1 120V only  
\*2 remote mount  
\*3 second driver required  
\*4 not available with ELDO, Lutron or DMX

# LETO 44 S A LRG

ASYMMETRIC SURFACE MOUNT LED DOWNLIGHT



## Reflector

### Faceted Reflector

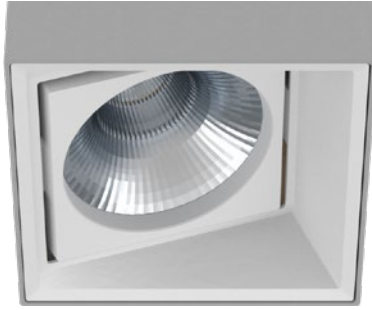

SENSO metal spun faceted reflectors are specifically designed to retain as much light as possible. This results in a more power efficient fixture with a higher delivered lumen.

## Accessories

### Diffusing Lens

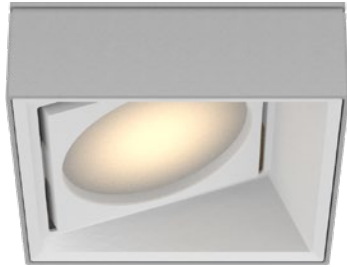

## Installation

- Mounting plate included
- Easy, single motion installation method
- Requires client supplied reducer ring (TNB 54 C 3)

## Construction / Finish

- High quality, scratch resistant powder coated finish in standard, premium or custom colors
- Aluminum extruded Body
- Made in Canada

## Dimensions

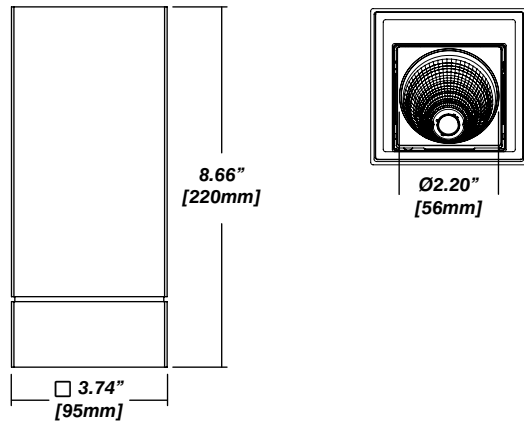

## Senso Driver Housings

### Single Remote Driver Housing

- Fits Standard, LCS or DIM drivers
- Galvanized steel enclosure
- For remote driver applications

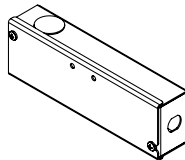

## Dimensions

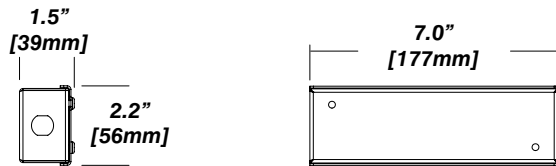

### Double Remote Driver Housing

- Fits all drivers
- Galvanized steel enclosure
- For remote driver applications

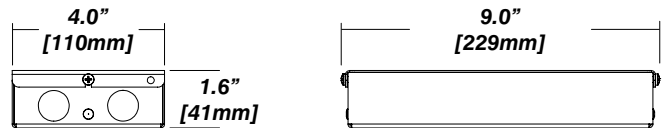
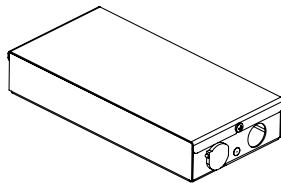

# LETO 44 S A LRG

ASYMMETRIC SURFACE MOUNT LED DOWNLIGHT



## Photometrics

SENSO's in-house photometric testing ensures that our lighting design can match your needs precisely. Our Goniophotometer and testing lab produces on-demand photometry files based on any specified fixture, including LM-79 Test reports, IES Files, and CRI/CCT measurements. See [SENSOlighting.com](http://SENSOlighting.com) for more information.

*\*Full photometric Reports and IES files available for every configuration*

## LED Module Performance

**Output:** Up to 113 lumen/Watt

**Efficacy:** Color consistency within a 3-MacAdam Ellipse

**CCT:** 2500K - 6500K

**Color Rendering:** 93+ CRI

**Min. R Values:** R<sup>9</sup> - 60 R<sup>1</sup> - 90 R<sup>0</sup> - 100

## Driver and Power Consumption

**Dimming:** 1% dimming standard with 0.1% option  
Casambi wireless control available

**Ripple:** Industry leading Low ripple

**Efficiency:** Power Factor >0.9

Efficiency over 85%

Class 2 output for safety

**Installation:** Fixture body or remote mounted

Lumen Option	700lm	1000lm	1500lm
Fixture Wattage	6.1W	9.1W	14W
Delivered Lumen	691lm	1018lm	1513lm

## Color Metrics

### TM 30-15

Our clients deserve the best information possible about their lighting choices. That's why SENSO has invested in the Illuminating Engineering Society (IES) TM 30-15, a new system that measures an LED light source's color rendering properties. Using SENSO's state-of-the-art goniophotometer, this method identifies the optimal light source for your project and helps evaluate the trade-offs between efficacy and color rendering. SENSO can provide TM 30-15 data for all of our products.

*\*Full Color Metric Info Available at [SENSOlighting.com](http://SENSOlighting.com)*