



Features

Kurba Large Vertical with Black Lens is a sleek, direct view, all black profile and lens that keeps the strip concealed in the off-state. Suitable for wet locations and capable of vertical/top bends up to 6" radius. Built with robust factory made power feeds or joiners, Kurba Large Vertical with Black Lens mounts to a specifically designed aluminum extruded channel.

Applications

Outdoor wet location

Operating Voltage

24VDC

Operating Temperature

-4°F to 113°F (-20°C to 45°C)

Average Life

50,000 hours

Dimming

Low voltage dimmer and class 2 dimming power supply required

Approvals

Class 2 wet listed, IP67

Warranty

3 years



Technical Information

Model	KBL-F-V-BL	CCT INFO / LUMEN MULTIPLIER	
LEDs/ft	38	Color Temperature	Multiplier (ref. -3000K)
Light Output at 3000K	38 lm/ft	2200K	0.98
Average Power Consumption at 4'	3.7 W/ft	2400K	1.00
Ordering Increment	2.19"	2700K	1.03
Maximum Run Length (In Series)	25 ft	3000K	1.00
		3500K	1.08
		4000K	1.10

Constraints

Bend Direction

Bend LED in these positions only to avoid damage

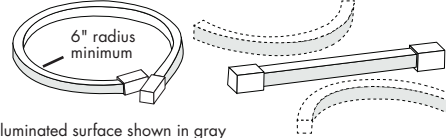

Illuminated surface shown in gray

Prohibited Bends

Twisting or bending LED in these positions will cause damage

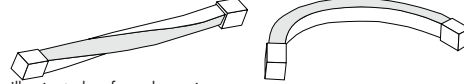

Illuminated surface shown in gray
Note: for horizontal bends refer to Luminii KBM series
Do not make sharp bends near the endcap

Power Feed Locations

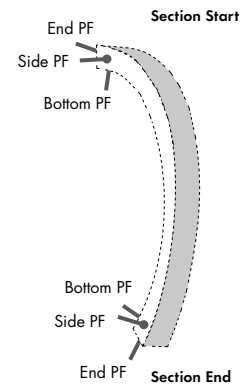

Section Start/End Power Feed Options

Injection Molded End Cap (IEC)

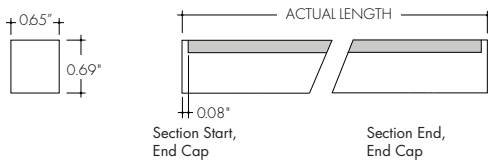

Injection Molded Bottom Power Feed (IBPF)

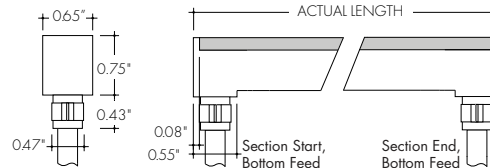

Injection Molded End Power Feed (IEPF)

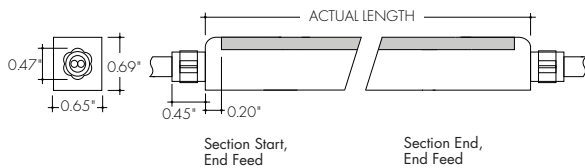

Injection Molded Side Power Feed (ISPF)

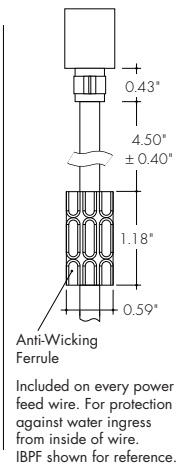
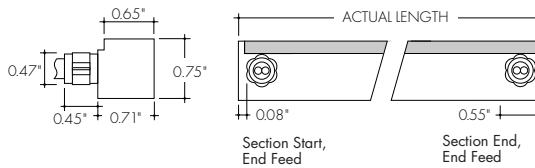

Included on every power feed wire. For protection against water ingress from inside of wire. IBPF shown for reference.

Ordering Code

MODEL	CCT	SECTION START	SECTION END	ACTUAL LENGTH
KBL-F-V-BL - Kurba Large, Flat, Vertical/Top Bend, Black Lens	22K-2200K 24K-2400K 27K-2700K 30K-3000K 35K-3500K 40K-4000K	IEPF - Injection Molded End power feed (9' wire lead) ¹ IBPF - Injection Molded Bottom power feed (9' wire lead) ¹ ISPF - Injection Molded Side power feed (9' wire lead) ^{1, 2} IEC - Injection Molded End cap ¹	IEPF - Injection Molded End power feed (9' wire lead) ¹ IBPF - Injection Molded Bottom power feed (9' wire lead) ¹ ISPF - Injection Molded Side power feed (9' wire lead) ^{1, 2} IEC - Injection Molded End cap ¹	See Power Consumption table on page 3 for available lengths

1 - 6-8 weeks lead time. Kurba injected-molded orders are non-cancellable. IEPF, IBPF, ISPF cannot be mixed and matched from Start to End except with IEC.

2 - ISPF Side power feeds selected for both Section Start and End will be located on the same side of the strip.

Mounting Accessories & Optional Connectors

MC-NFS-KBL-F-V-78

Mounting Channel with Grip, 78"

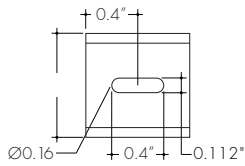
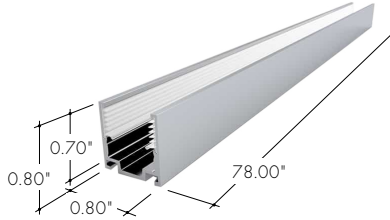

Aluminum mounting channel providing grip. For use with light strip mounted to the ceiling.

MB-KBL-F-V-ST

Mounting Bracket with Grip

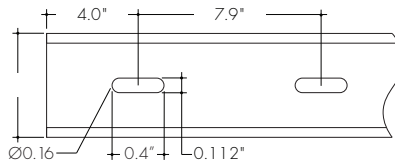
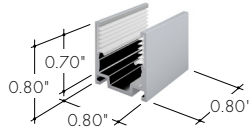

Aluminum mounting bracket providing grip. For use with light strip mounted to the ceiling. 1 recommended every 8 in.

MC-FS-KBL-F-V-78

Flanged Mounting Channel with grip, 78"

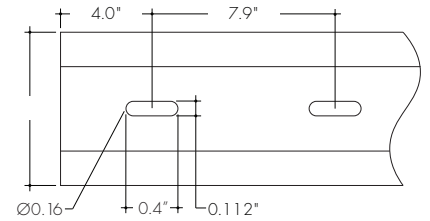
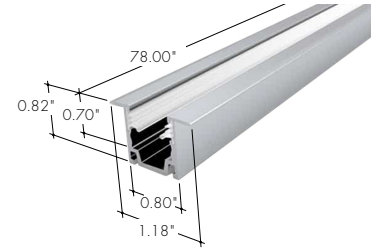

Flanged aluminum mounting channel providing grip. For use with light strip mounted to the ceiling.

MC-BNS-KBL-F-V-34

Bendable Mounting Channel with grip, 34"

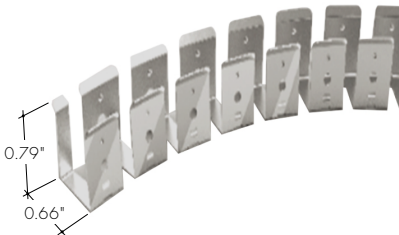

Bendable stainless steel mounting channel providing grip. For use with light strip mounted to the ceiling.

LVSP-WET

Splice Box

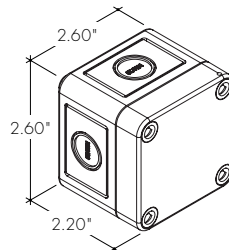

Wet rated, low voltage splice box, gray.

LVSP-WET-CM

Connector

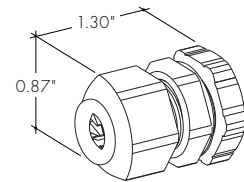

Low voltage splice box wet cable management, gray.

Power Consumption Per Fixture Length

Based on operation with PDCU series of power supplies. Use Actual Length for Order Code Entry
 Tolerance for Actual Lengths less than 6 ft is +/- 0.2", Actual Lengths between 6 ft and 16 ft is +/- 0.3", and Actual Lengths greater than 16 ft is +/- 0.6"

Nominal Length (in)	Actual Length (in)				Nominal Length (in)	Actual Length (in)				Nominal Length (in)	Actual Length (in)				Nominal Length (in)	Actual Length (in)			
	W	IEPF IEPF	IEC IEPF	IEC IBPF ISPF		W	IEPF IEPF	IEC IEPF	IEC IBPF ISPF		W	IEPF IEPF	IEC IEPF	IEC IBPF ISPF		W	IEPF IEPF	IEC IEPF	IEC IBPF ISPF
3	-	-	-	-	80	24.1	79.1	79	78.9	(13 ft) 156	47.5	155.7	155.6	155.5	233	70.8	232.3	232.1	232
5	-	-	-	-	81	24.8	81.3	81.2	81.1	158	48.1	157.9	157.8	157.7	235	71.5	234.5	234.3	234.2
7	2.1	7	6.8	6.7	(7 ft) 84	25.5	83.5	83.4	83.3	160	48.8	160.1	160	159.8	237	72.1	236.6	236.5	236.4
9	2.8	9.1	9	8.9	86	26.1	85.7	85.6	85.5	162	49.5	162.3	162.1	162	(20 ft) 239	72.8	238.8	238.7	238.6
(1 ft) 11	3.5	11.3	11.2	11.1	88	26.8	87.9	87.8	87.7	165	50.1	164.5	164.3	164.2	241	73.5	241	240.9	240.8
14	4.1	13.5	13.4	13.3	90	27.5	90.1	90	89.8	167	50.8	166.6	166.5	166.4	243	74.1	243.2	243.1	243
16	4.8	15.7	15.6	15.5	92	28.1	92.3	92.2	92	(14 ft) 169	51.5	168.8	168.7	168.6	246	74.8	245.4	245.3	245.1
18	5.5	17.9	17.8	17.7	95	28.8	94.5	94.3	94.2	171	52.1	171	170.9	170.8	248	75.5	247.6	247.5	247.3
20	6.1	20.1	20	19.8	(8 ft) 97	29.5	96.6	96.5	96.4	173	52.8	173.2	173.1	173	250	76.1	249.8	249.6	249.5
22	6.8	22.3	22.2	22	99	30.1	98.8	98.7	98.6	176	53.5	175.4	175.3	175.2	(21 ft) 252	76.8	252	251.8	251.7
(2 ft) 24	7.5	24.5	24.3	24.2	101	30.8	101	100.9	100.8	178	54.1	177.6	177.5	177.3	254	77.5	254.1	254	253.9
27	8.1	26.6	26.5	26.4	103	31.5	103.2	103.1	103	(15 ft) 180	54.8	179.8	179.6	179.5	257	78.1	256.3	256.2	256.1
29	8.8	28.8	28.7	28.6	106	32.1	105.4	105.3	105.2	182	55.5	182	181.8	181.7	259	78.8	258.5	258.4	258.3
31	9.5	31	30.9	30.8	(9 ft) 108	32.8	107.6	107.5	107.3	184	56.1	184.1	184	183.9	261	79.5	260.7	260.6	260.5
33	10.1	33.2	33.1	33	110	33.5	109.8	109.7	109.5	187	56.8	186.3	186.2	186.1	(22 ft) 263	80.1	262.9	262.8	262.6
(3 ft) 35	10.8	35.4	35.3	35.2	112	34.1	112	111.8	111.7	189	57.5	188.5	188.4	188.3	265	80.8	265.1	265	264.8
38	11.5	37.6	37.5	37.3	114	34.8	114.1	114	113.9	(16 ft) 191	58.1	190.7	190.6	190.5	268	81.5	267.3	267.1	267
40	12.1	39.8	39.7	39.5	116	35.5	116.3	116.2	116.1	193	58.8	192.9	192.8	192.7	270	82.1	269.5	269.3	269.2
42	12.8	42	41.8	41.7	119	36.1	118.5	118.4	118.3	195	59.5	195.1	195	194.8	272	82.8	271.6	271.5	271.4
44	13.5	44.1	44	43.9	(10 ft) 121	36.8	120.7	120.6	120.5	198	60.1	197.3	197.1	197	274	83.5	273.8	273.7	273.6
46	14.1	46.3	46.2	46.1	123	37.5	122.9	122.8	122.7	200	60.8	199.5	199.3	199.2	(23 ft) 276	84.2	276	275.9	275.8
(4 ft) 49	14.8	48.5	48.4	48.3	125	38.1	125.1	125	124.8	202	61.5	201.6	201.5	201.4	279	84.8	278.2	278.1	278
51	15.5	50.7	50.6	50.5	127	38.8	127.3	127.1	127	(17 ft) 204	62.1	203.8	203.7	203.6	281	85.5	280.4	280.3	280.1
53	16.1	52.9	52.8	52.7	130	39.5	129.5	129.3	129.2	206	62.8	206	205.9	205.8	283	86.2	282.6	282.5	282.3
55	16.8	55.1	55	54.8	(11 ft) 132	40.1	131.6	131.5	131.4	208	63.5	208.2	208.1	208	285	86.8	284.8	284.6	284.5
57	17.5	57.3	57.2	57	134	40.8	133.8	133.7	133.6	211	64.1	210.4	210.3	210.2	(24 ft) 287	87.5	286.9	286.8	286.7
(5 ft) 60	18.1	59.5	59.3	59.2	136	41.5	136	135.9	135.8	213	64.8	212.6	212.5	212.3	289	88.2	289.1	289	288.9
62	18.8	61.6	61.5	61.4	138	42.1	138.2	138.1	138	(18 ft) 215	65.5	214.8	214.6	214.5	292	88.8	291.3	291.2	291.1
64	19.5	63.8	63.7	63.6	141	42.8	140.4	140.3	140.2	217	66.1	217	216.8	216.7	294	89.5	293.5	293.4	293.3
66	20.1	66	65.9	65.8	143	43.5	142.6	142.5	142.3	219	66.8	219.1	219	218.9	296	90.2	295.7	295.6	295.5
68	20.8	68.2	68.1	68	(12 ft) 145	44.1	144.8	144.6	144.5	222	67.5	221.3	221.2	221.1	298	90.8	297.9	297.8	297.6
70	21.5	70.4	70.3	70.2	147	44.8	147	146.8	146.7	224	68.1	223.5	223.4	223.3	(25 ft) 300	91.5	300.1	300	299.8
(6 ft) 73	22.1	72.6	72.5	72.3	149	45.5	149.1	149	148.9	226	68.8	225.7	225.6	225.5					
75	22.8	74.8	74.7	74.5	152	46.1	151.3	151.2	151.1	(19 ft) 228	69.5	227.9	227.8	227.6					
77	23.5	77	76.8	76.7	154	46.8	153.5	153.4	153.3	230	70.1	230.1	230	229.8					

Note: all values are rounded to the nearest 0.1 inch

Injection Molded End Cap (IEC)

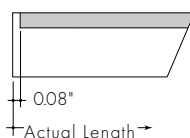

Injection Molded Bottom Power Feed (IBPF)

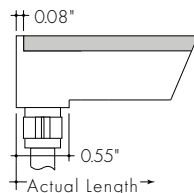

Injection Molded Side Power Feed (ISPF)

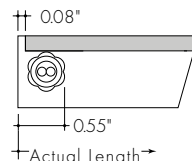

Injection Molded End Power Feed (IEPF)

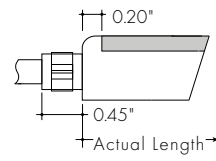

Power Supplies

See Power Supply instructions and spec sheet for wiring information. For a complete list of compatible dimmers, see Compatible Dimming Chart on the Resources page.

Universal Power Supply 1% 120VAC - 277VAC

MODEL	POWER	OUTPUT
PDCU-D - IP20 Dry Series	30 - 30 W 60 - 60 W 96 - 96 W 3X96 - 3X96 W	24 - 24 VDC
PDCU-W - IP66 Wet Series	96 - 96 W 3X96 - 3X96 W	

0-10V dims down to 1%, MLV/ELV/TRIAC dims down to 1%.
For a complete list of compatible dimmers, see [Compatible Dimming Chart](#) on the Resources page.

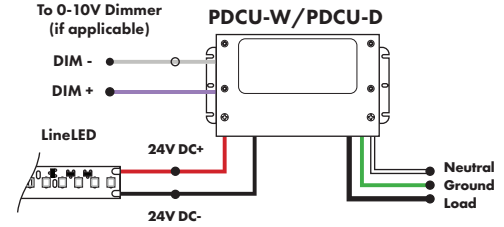

MODELS	PDCU-W 96W	PDCU-W 3X96W	PDCU-D 30W	PDCU-D 60W	PDCU-D 96W	PDCU-D 3X96W
Length	8.66"	11.85"	6.10"	7.93"	8.25"	9.57"
Width	3.73"	4.32"	3.35"	3.35"	4.10"	5.94"
Depth	1.61"	1.81"	1.33"	1.32"	1.56"	1.13"

0-10V Dimming Power Supplies 0.1% 120VAC - 277VAC

MODEL	POWER	OUTPUT	DIMMING
PS010V - 0-10V Power Supply dims down to 0.1%	96 - 96 Watt 3X96 - 3 X 96 Watt	24 - 24 VDC	LIN - Linear LOG - Logarithmic

MODELS	96W	3X96
Length	14.40"	15.75"
Width	5.20"	6.62"
Depth	2.60"	4.95"

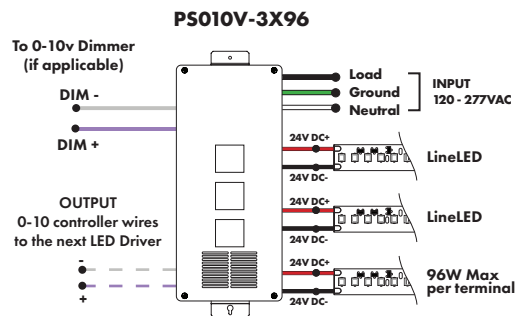
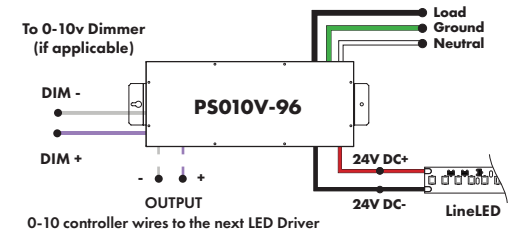

Triac, MLV, & ELV Compatible Dimmers

MODEL	POWER	OUTPUT
PDC - (IP20) Power Supply	96 - 96 Watts	24 - 24 VDC

MODELS	96W
Length	8.25"
Width	4.10"
Depth	1.56"

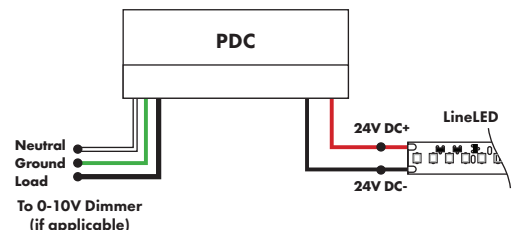

Power Supplies

See Power Supply instructions and spec sheet for wiring information. For a complete list of compatible dimmers, see Compatible Dimming Chart on the Resources page.

DMX Dimming Power Supplies 120VAC - 277VAC

MODEL	POWER	OUTPUT
PSDMX - DMX Power Supply dims down to 0%	96 - 96 Watt 3X96 - 3 X 96 Watt	24 - 24 VDC

Features eldoLED's LINEARdrive configurable dimmable drivers

MODELS	96W	3X96
Length	14.40"	15.75"
Width	5.20"	6.62"
Depth	2.60"	4.95"

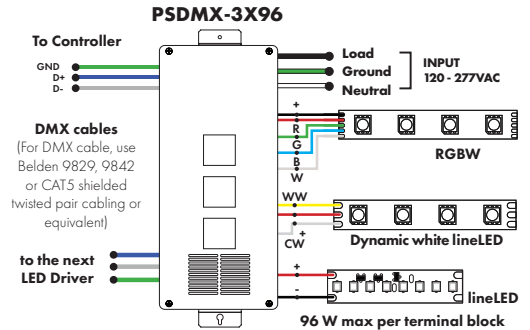
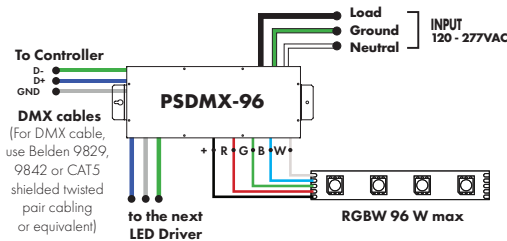

DALI 0% Dimming Power Supplies 120VAC - 277VAC

MODEL	POWER	OUTPUT
PSDALI - DALI Power Supply dims down to 0%	96 - 96 Watt 3X96 - 3 X 96 Watt	24 - 24 VDC

Features eldoLED's LINEARdrive configurable dimmable drivers

Model	96W	3X96
Length	14.40"	15.75"
Width	5.20"	6.62"
Depth	2.60"	4.95"

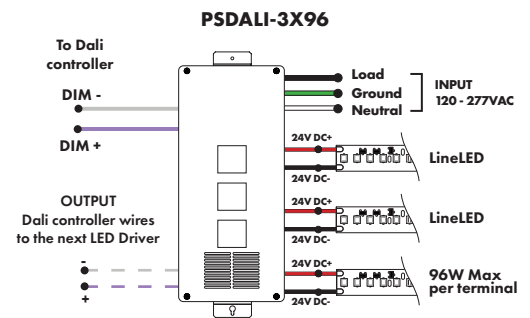
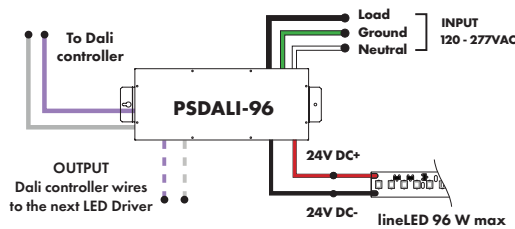

Enlighted Enabled Dimming Power Supplies 120VAC - 277VAC

MODEL	POWER	OUTPUT	DIMMING	LOCATION
PSV - PSV Series	96 - 96 Watt	24 - 24 VDC	ENL - Enlighted Dimming dims down to 0%	D - Damp

Model	96W
Length	14.40"
Width	5.20"
Depth	2.60"

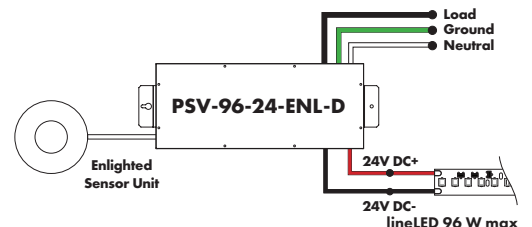

Power Supplies

See Power Supply instructions and spec sheet for wiring information. For a complete list of compatible dimmers, see Compatible Dimming Chart on the Resources page.

Non-Dimming Power Supply 120VAC - 277VAC

MODEL	POWER	OUTPUT	DIMMING	LOCATION
PSV - PSV Series	96 - 96 Watt	24 - 24 VDC	ND - Non Dimming	D - Damp

MODELS	96W
Length	14.40"
Width	5.20"
Depth	2.60"

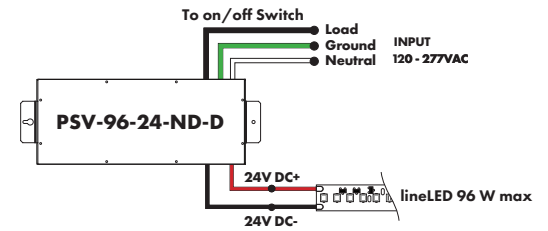

Luminii is a Lutron OEM Advantage Partner

Lutron Power Supplies 1%

MODEL
L3DA4U1UKL-CV240

HiLume™ 1% EcoSystem Voltage LED driver
40W max

MODELS	L3DA4U1UKL-CV240
Length	4.98"
Width	4.00"
Depth	2.62"

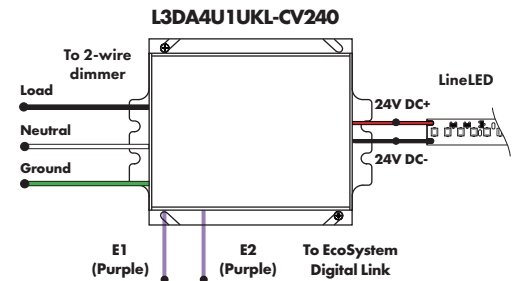

Luminii is a Lutron OEM Advantage Partner

Lutron Power Supplies 0.1%

MODEL
L3D0-96W24V-U

HiLume™ 0.1% EcoSystem Voltage LED Driver with Soft-On, Fade-to-Black™
96W max

MODELS	L3D0
Length	10.50"
Width	5.50"
Depth	2.00"

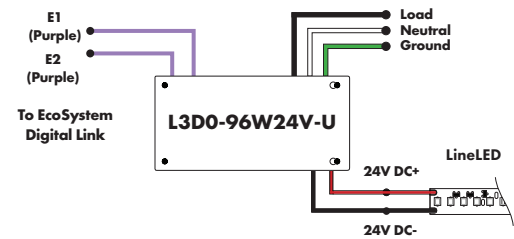

In-Ground Power Supplies

MODEL	POWER	OUTPUT	INPUT
IG - In ground CVE Series	CVE - ELV Dimming DALI - eldoLED Dali dimming Both dims down to 0%	96X2 - 2 X 96 Watt	Blank - 120 V 277 - 240/277 V

MODELS	Dual Circuit
Length	8.40"
Width	8.30"
Depth	8.10"

