



**Features**

- Surface Mount Track supports Stenos directional and ambient modules
- Minimalist and narrow track seamlessly integrates into environments
- Two channel track allows independent dim control for groups of modules when paired with appropriate power supplies
- 24 VDC Class 2 power supply
- Snap-in Electrical Joiners include magnetic black/white Cover Plates to maintain clean aesthetic.
- Custom drawing and approval is required for every STENOS Track System prior to order acceptance.
- 4A max on track
- 96W max on track per power supply
- Dry location only

**Finish Options**

- Black powder coated
- White powder coated



**Product Dimensions**

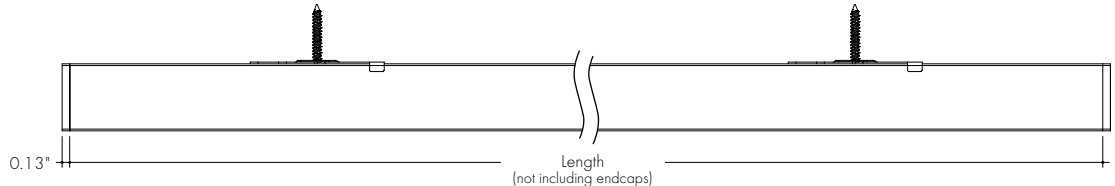
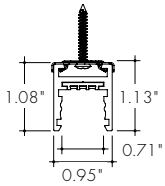

Straight Run



L Shape



U Shape

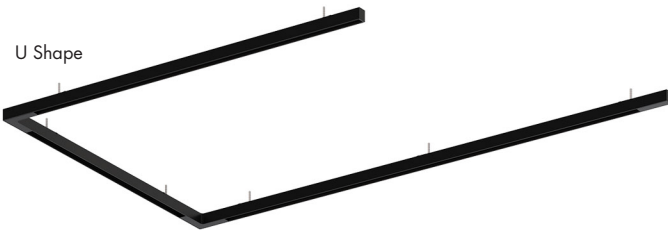

Rectangle Shape

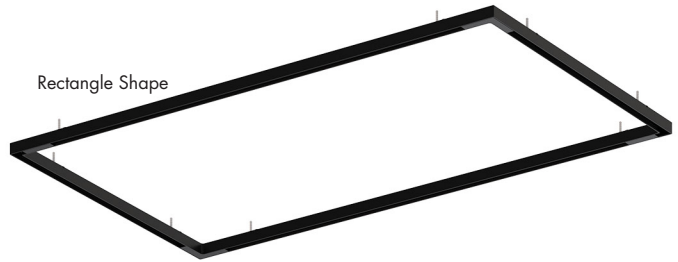

**Ordering Code**

example: STS-R-40-BK-2CHDMX-240-XXXXXX-X

MODEL <sup>1</sup>	SHAPE	OVERALL LENGTH <sup>2</sup>	FINISH	POWER SUPPLY <sup>3</sup>	WATTAGE	SERIAL NUMBER
STS - Stenos Surface Track	S - Straight Run R - Rectangle Shape L - L Shape U - U Shape	- Overall run length of system/shape (rounded up to the nearest foot)	BK - Black WH - White	2CHDMX - 2 Channel DMX, 0.1%, PSDMX DWDT8 - Dynamic White, DALI DT8, 0.1%, PSDALI-DT8 DW010V - Dynamic White 0-10V, 0.1%, PS010VD-W2C WDO10V - Warm Dim Curve (with Dynamic White Module), 0-10V, 0.1%, PS010VD-WW DWDT8-AWNR - Dynamic White, DALI DT8 with Lutron Athena, 0.1%, PSDALI-DT8-AWNR WDO10V-AWNR - Warm Dim Curve (with Dynamic White Module), 0-10V with Lutron Athena, 0.1%, PS010VD-WW-AWNR	- Watts (rounded up to the nearest Watt, see Wattage Calculation Guide, next page)	Serial Number, entered by Luminii

1 - Custom drawing and approval is required for every STENOS Track System prior to order acceptance. Allow 2 weeks (typical) for custom drawing generation/confirmation process. Use STENOS Track System Sketch Grid to convey as many details as possible including: shape, dimension of each leg, desired location of power feeds, and location of track modules (Directional, Ambient, Track Heads).  
 2 - Mechanical joiners are required for sections longer than 12ft.  
 3 - Power supplies are 120-277 VAC input, unless otherwise noted.

Product Dimensions

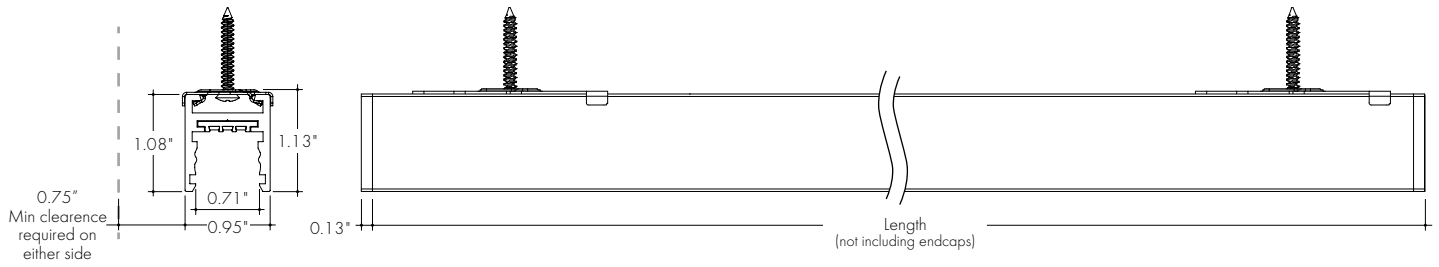

Stenos Track with Ambient Module

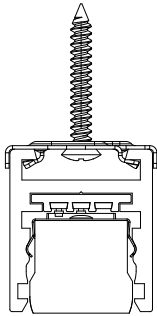

Stenos Track with Directional Module

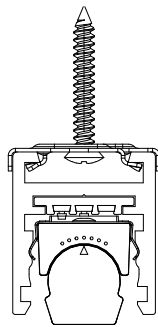

Stenos Track with Directional Module with louver

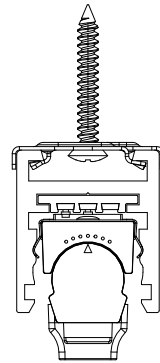

Wattage Calculation Guide

Stenos Track Module	Wattage	Lumens (3000K)	Length	Reference
<b>STENOS 3" Directional Module</b>	2.6 W	250 lm	2.5 in	
<b>STENOS 5" Directional Module &amp; STENOS 5" Wall Wash Module</b>	5.4 W	520 lm 275 lm	4.8 in	
<b>STENOS 12" Directional Module &amp; STENOS 12" Wall Wash Module</b>	13.0 W	1260 lm 665 lm	11.8 in	
<b>STENOS 1" Track Head Long</b> 15° optic Regressed Baffle	6.6 W	565 lm	4.9 in	
<b>STENOS 1" Track Head Short</b> 15° optic Regressed Baffle	5.2 W	458 lm		
<b>STENOS 24" Ambient Module SO</b>	5.5 W	475 lm	24.4 in	
<b>STENOS 24" Ambient Module HO</b>	12.3 W	1000lm	24.4 in	
<b>STENOS 48" Ambient Module SO</b>	11.0 W	950 lm	48.0 in	
<b>STENOS 48" Ambient Module HO</b>	24.7 W	2025 lm	48.0 in	

Wattage Calculation Guide (Example)

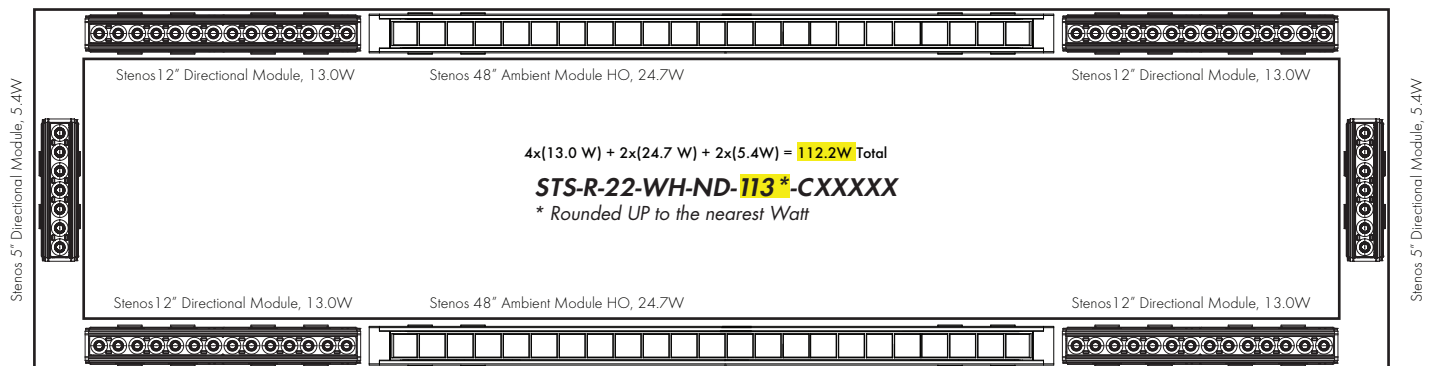

Factory Built Sections

Straight  
Run

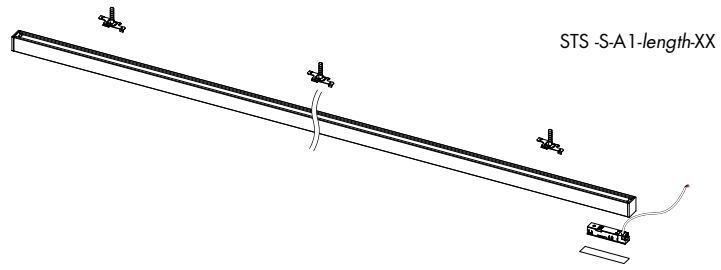

L Shape

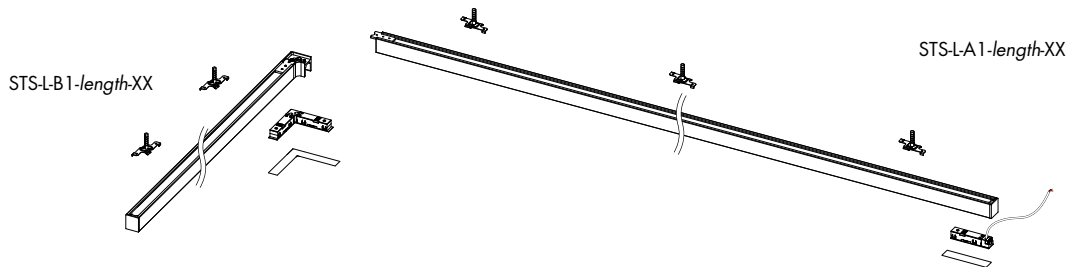

U Shape

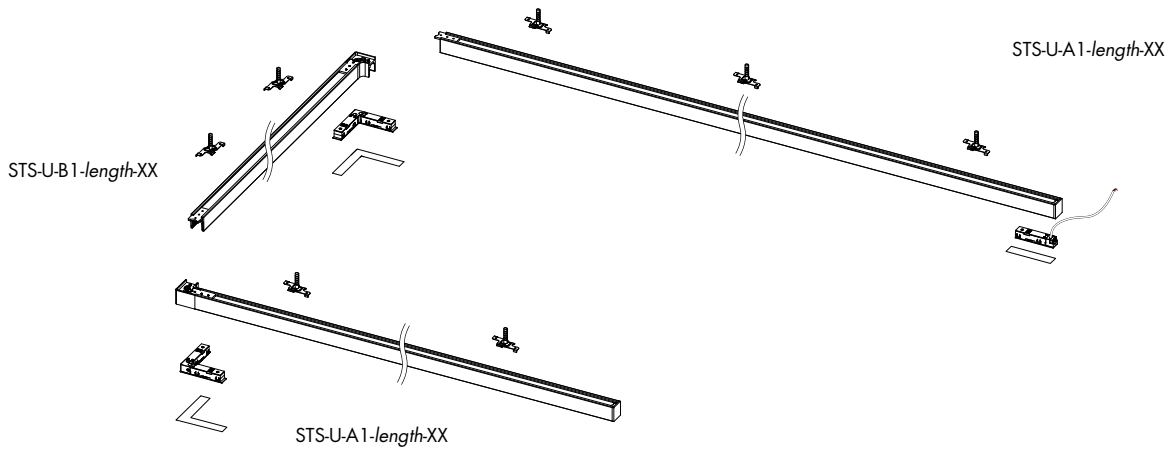

Rectangle Shape

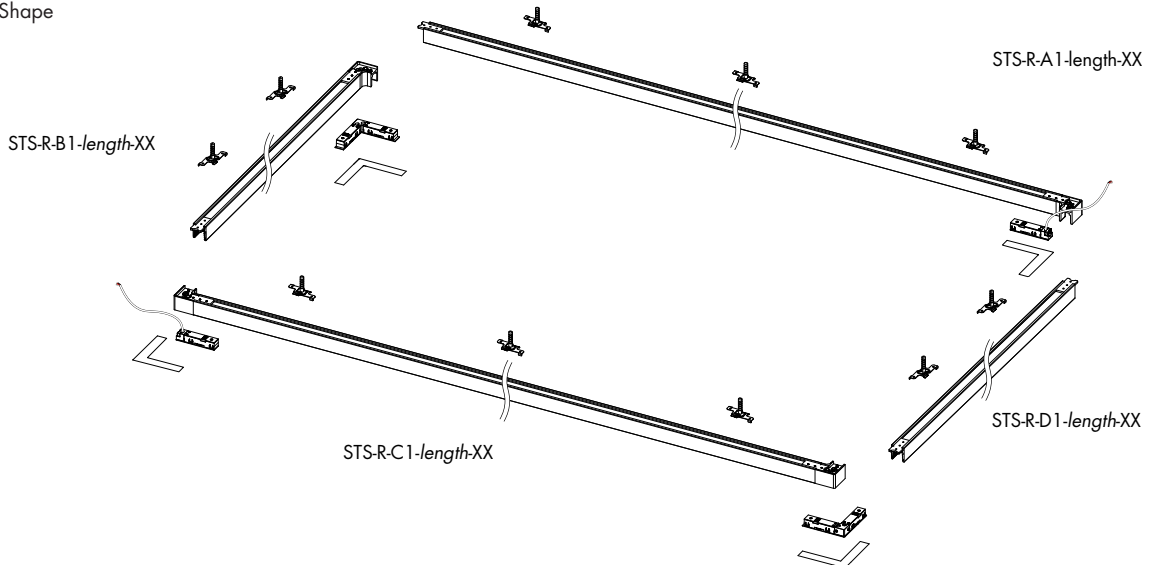

### Power Supplies

See Power Supply instructions and spec sheet for wiring information. For a complete list of compatible dimmers, see Compatible Dimming Chart on the Resources page.

### Dynamic White Control

#### -2CHDMX

2 CHANNEL DMX, 0.0%, 120-277VAC, PSDMX

<b>MODELS</b>	<b>96W</b>
<b>Length</b>	14.40"
<b>Width</b>	5.20"
<b>Depth</b>	2.60"

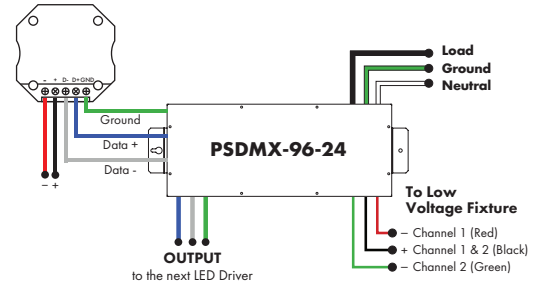

#### -DWDT8

DYNAMIC WHITE, DALI DT8, 0.1%, PSDALI-DT8

<b>MODELS</b>	<b>96W</b>
<b>Length</b>	14.40"
<b>Width</b>	5.20"
<b>Depth</b>	2.60"

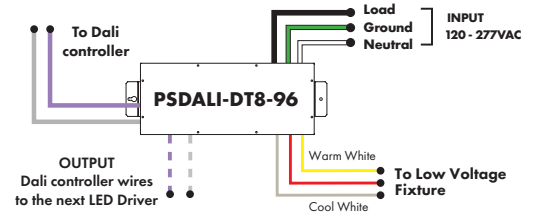

#### -DW010V

DYNAMIC WHITE 0-10V, 0.1%, PSV010-W2C, PS010VD-W2C

<b>MODELS</b>	<b>96W</b>
<b>Length</b>	14.40"
<b>Width</b>	5.20"
<b>Depth</b>	2.60"

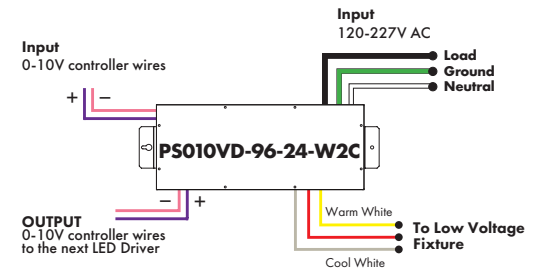

### Warm Dim Control (With Dynamic White Module)

#### -WD010V

WARM DIM CURVE (WITH DYNAMIC WHITE MODULE), 0-10V, 0.1%, PS010VD-WW

<b>MODELS</b>	<b>96W</b>
<b>Length</b>	14.40"
<b>Width</b>	5.20"
<b>Depth</b>	2.60"

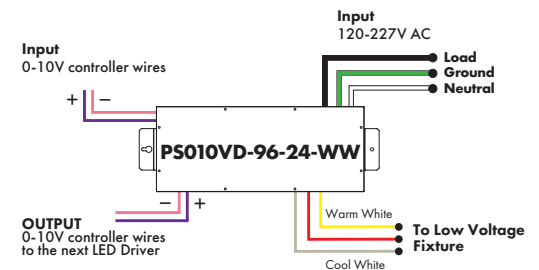
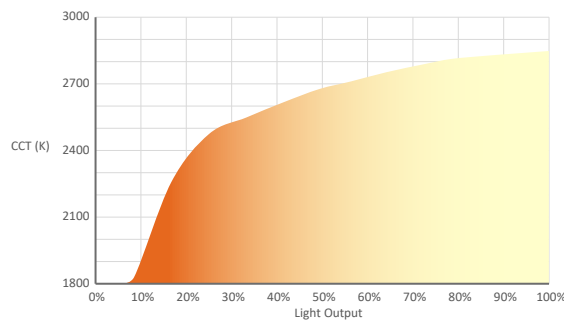

**Track Components (for field configurable systems)**

To minimize voltage drop, it is recommended to not exceed 24ft of track per power feed or 3 track joiners per power feed.

**EC-ST5-H3-SF-XX**  
Surface End Caps

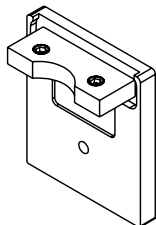

Blank End Cap for ending a Surface run

**ST-JOIN-M-TB**  
Surface Mechanical Joiner Bracket

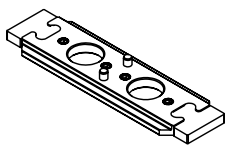

Used for mechanically joining adjacent Track sections

**TC-96-XX**  
Track Cover, 96"

**TC-144-XX**  
Track Cover, 144"

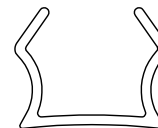

Track Covers ship complete with Surface Track and cover unoccupied sections of track. They are field cuttable. Additional can be ordered, if necessary

**JOIN-M-L-ST5-XX**  
Surface Mechanical L Joiner

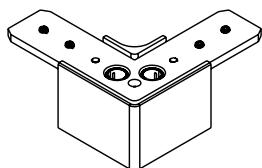

For creating a 90° in-plane corner

**JOIN-M-W-ST5-XX**  
Surface Mechanical Wall-to-Ceiling Joiner

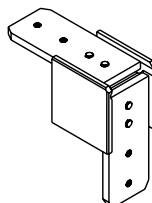

For creating a 90° Wall to Ceiling corner

**ST5-48/96/144-SF-XX**  
Stenos Track, Surface

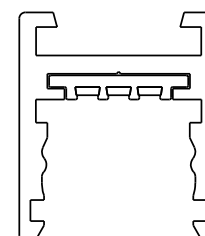

XX	Color
WH	White
BK	Black

**ST-JOIN-E-P**  
Electrical Power Feed, with black and white Cover Plates

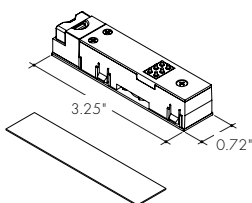

For use with 18AWG field wires with max outer diameter 0.3" (cable and power feed do not ship pre-assembled)

**ST-JOIN-E-P-72**  
Electrical Power Feed, 72" Plenum Cable

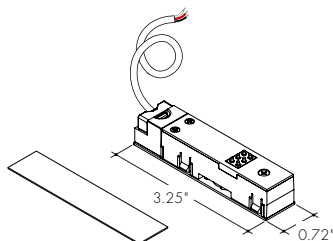

(Not for concealed recessed wiring) (cable and power feed do not ship pre-assembled)

**ST-JOIN-E-P-108-XX**  
Electrical Power Feed, 108" Black/White Jacket Cable

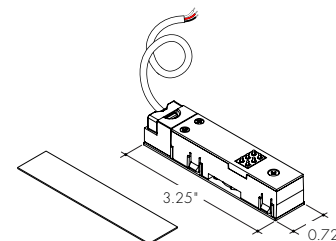

(Not for concealed recessed wiring) (cable and power feed do not ship pre-assembled)

**ST-JOIN-E-S**  
Electrical Joiner, Straight, with black and white Cover Plates

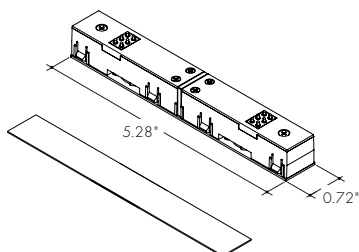

For electrically joining adjacent Track sections

**ST-JOIN-E-L**  
Electrical Joiner, L with black and white Cover Plates

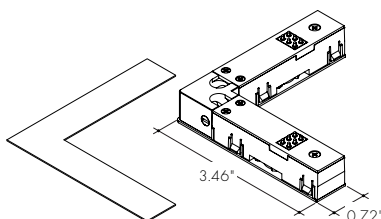

For for use with Mechanical L Joiner

**ST-JOIN-E-F**  
Electrical Joiner, Flexible with black and white Cover Plates

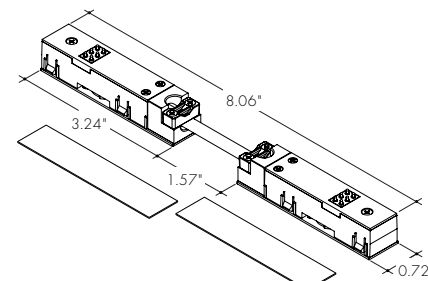

For use with Mechanical L Joiner or Wall to Ceiling Joiner

### Wiring and Multiple Channels

For **single channel** use, connect black and white power feed wires.

For **two channel** use, connect per wiring diagram in the Two Channel Control section of power supplies

For **Dynamic White** use, connect per wiring diagram in the Dynamic White section of power supplies

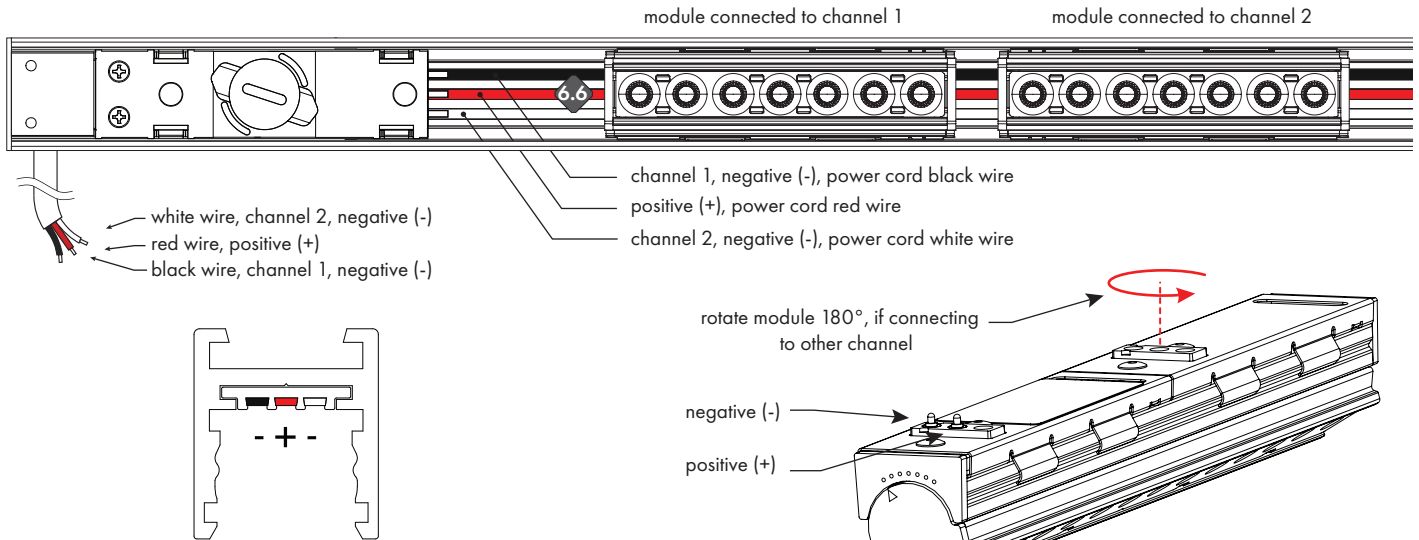

The Power Track contains three copper conductors allowing two channel control .

- Center conductor is common positive (+), connected to power cord red wire
- One outer conductor is channel 1 negative (-), connected to power cord black wire
- Other outer conductor is channel 2 negative (-), connected to power cord white wire

Select control channel for Stenos Directional and Ambient Modules by rotating them 180°

For **two channels** use, connect per wiring diagram in the Two Channel Control section of power supplies

For **single channel** use, connect black and white power feed wires.

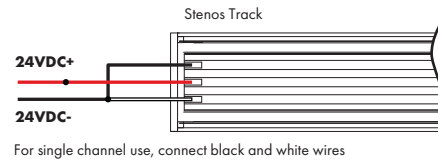

**STENOS Track System Sketch Grid**

Use grid below to sketch out details of the STENOS Track System. Include as many details as possible such as:

- Shape
- Dimensions of each leg
- Location of Power Feeds
- Location and Type of Track Modules (Directional, Ambient, Track Heads)

**Note:** 96W max, 24ft max,  
and 3 electrical joiners max  
per power feed  
See example on next page

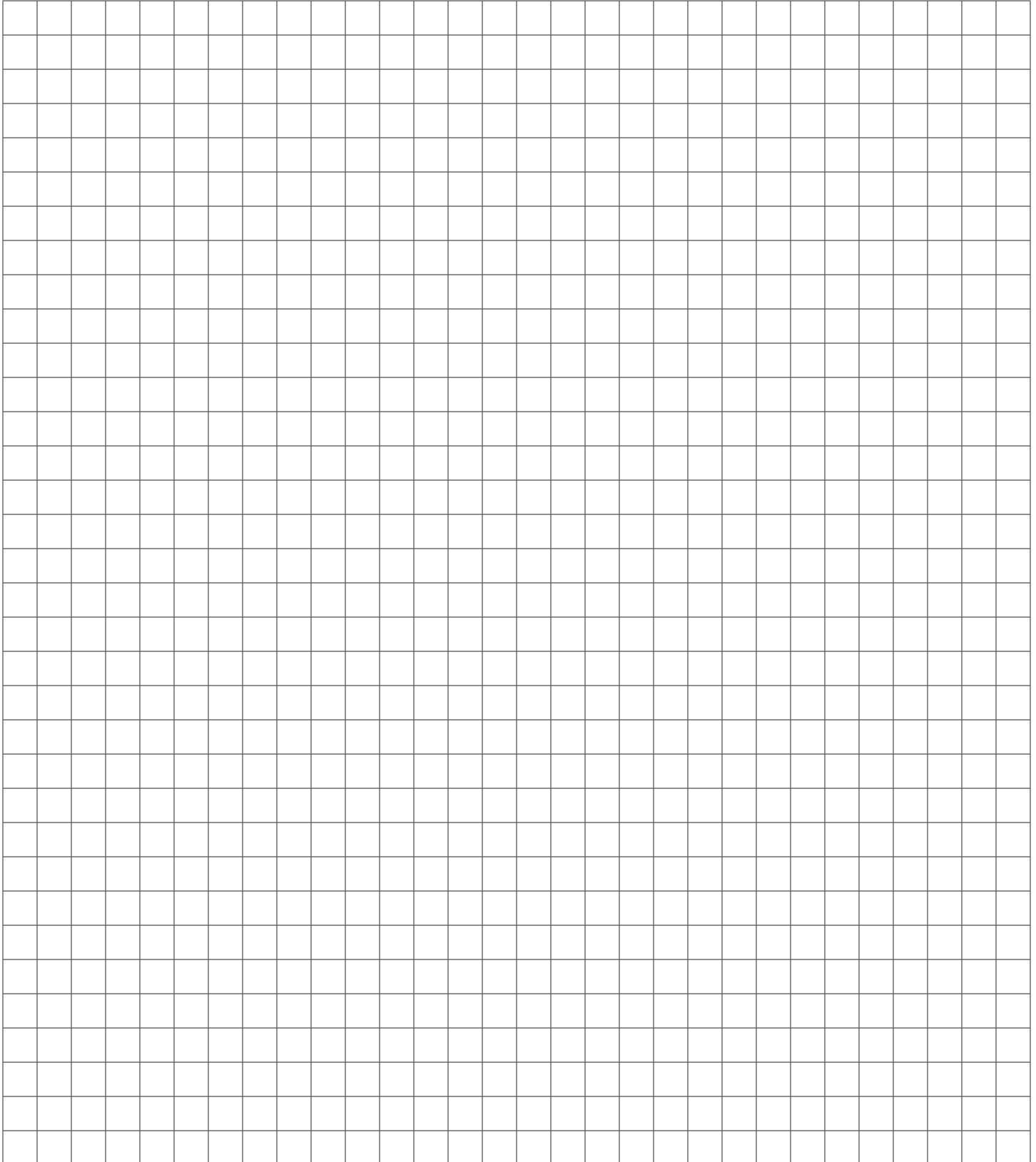



**STENOS Track System Sketch Grid (Example)**

Use grid below to sketch out details of the STENOS Track System. Include as many details as possible such as:

- Shape
- Dimensions of each leg
- Location of Power Feeds
- Location and Type of Track Modules (Directional, Ambient, Track Heads)

**Note:** 96W max, 24ft max, and 3 electrical joiners max per power feed

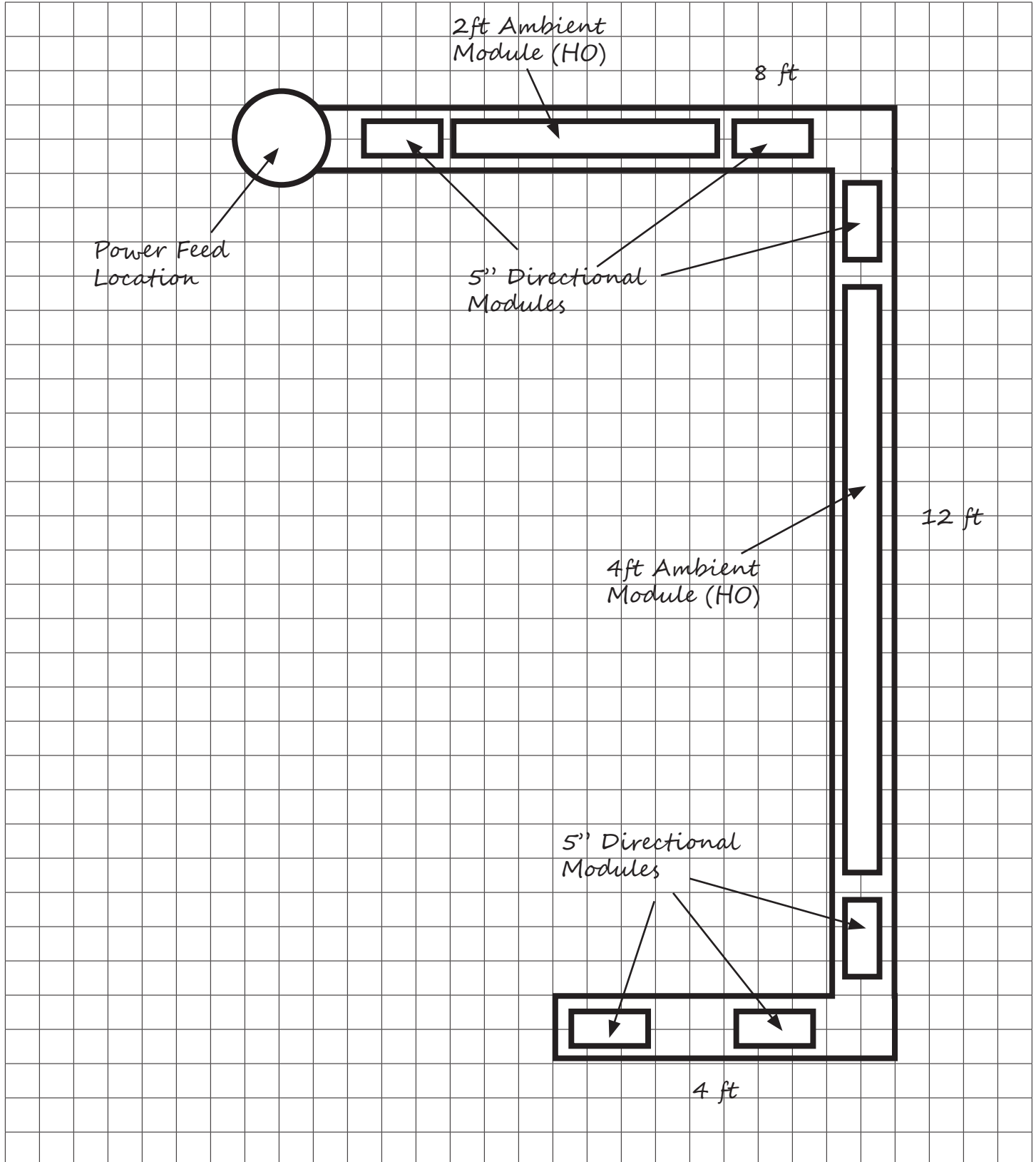

Additional Stenos Products



(left to right)  
Stenos Recessed Deep Trimless Track  
Stenos Recessed Trimless Track  
Stenos Recessed Trimmed Track  
Stenos Surface Mount Track  
Stenos Suspended Track



Stenos Directional Module

Stenos Directional Module with Louver

Stenos Directional Module with Wall Wash

Stenos Ambient Module

Stenos Ambient Module with Louver

